



PALADIN®

RENTAL CATALOG

**Selection,
Innovation,
Performance**

Your One-Stop Shop
for Hydraulic Tools
and Attachments

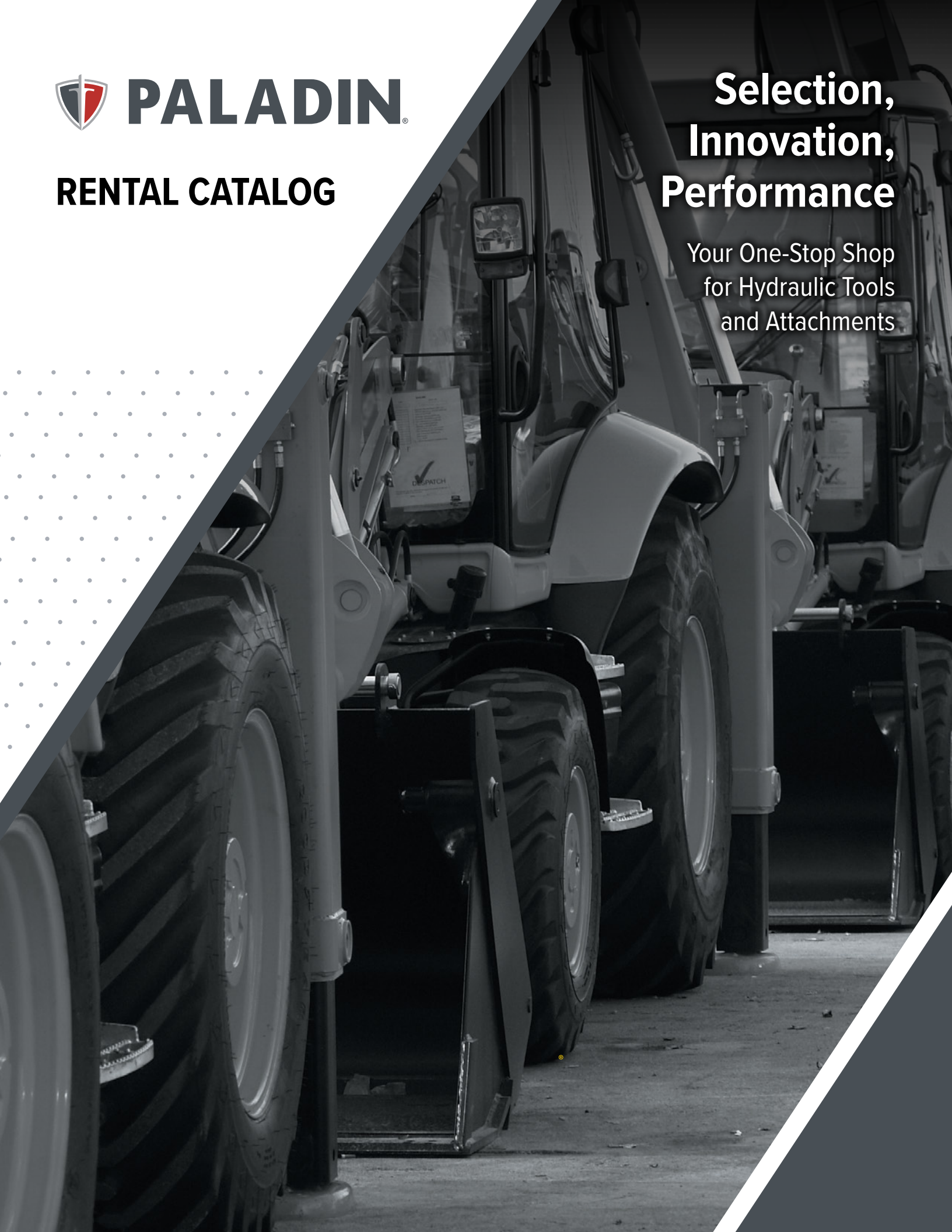



TABLE OF CONTENTS

Skid-Steer Attachments

CS Series Auger Drives.....	4
Auger Bits/Extensions.....	5-6
Angle Brooms.....	7
Pick Up Sweepers.....	7
Buckets.....	8
Post Driver.....	8
Grapple Buckets.....	9
Multi-Purpose Bucket (4-in-1).....	10
Autorake®.....	10
Landscape Rakes.....	11
Ground Shark™ Brush Cutters.....	12
Concrete Claw.....	14
Concrete Chuter.....	14
Mulchers-Drum Style.....	15
Mulcher-Disk Style.....	16
Dozer Blade.....	17
Stump Grinder.....	17
Trenchers.....	18
Cold Planers.....	18
Pallet Forks.....	19
SharkBite™ Grapple.....	19
Snow Push.....	20
IceShark™ Snow Blowers.....	21-22

Mini Skid-Steer Attachments

Buckets.....	23
Grapples.....	24
Trenchers.....	24
Landscape Rake.....	25
Pallet Forks.....	25
CS Series Auger Drives.....	26
Stump Grinder.....	27
Tillers.....	27

Mini Excavator Attachments

Machine Classification.....	28-29
Quick Hitch Buckets.....	30
Quick Hitch Couplers.....	31
Main Pin Thumbs.....	31
MX Series Brush Cutter.....	32

Excavator Attachments

HD & Ditch Buckets.....	34-35
-------------------------	-------

Wheel Loader/Backhoe Attachments

Machine Classification.....	36
General Purpose Bucket.....	38
Snow Push.....	38
Construction Forks.....	39
Loader Rake.....	39

CS SERIES AUGER DRIVE UNITS



- Hunting gearing as standard for increased life and efficiency
- Secure lock shaft
- Compact housing design for easy handling and increased strength and durability
- Oversized bearing for improved load handling
- Extreme shaft seals for reduced service intervals
- Compact, high torque, efficient hydraulic motors for improved drilling productivity
- Easy access service points for user friendly maintenance
- Full connection contact between auger hub and auger drive unit

SKID STEER MOUNT BUNDLES HOSE ROUTED OUT THE SIDE					
ORDER CODE	DESCRIPTION	OUTPUT SHAFT	MOUNT	QD INCLUDED	SHIP WEIGHT (LBS)
810237N-0022	CS 16-15 AUGER DRIVE	2.563 IN ROUND	UNIVERSAL SSL	1/2	277
810238N-0022	CS 16-15 AUGER DRIVE	2 IN HEX	UNIVERSAL SSL	1/2	277
810335N-0022	CS 28-22 AUGER DRIVE	2.563 IN ROUND	UNIVERSAL SSL	1/2	305
810336N-0022	CS 28-22 AUGER DRIVE	2 IN HEX	UNIVERSAL SSL	1/2	305
810340N-0022	CS 35-25 AUGER DRIVE	2.563 IN ROUND	UNIVERSAL SSL	1/2	305
810341N-0022	CS 35-25 AUGER DRIVE	2 IN HEX	UNIVERSAL SSL	1/2	305
810345N-0022	CS 41-25 AUGER DRIVE	2.563 IN ROUND	UNIVERSAL SSL	1/2	307
810346N-0022	CS 41-25 AUGER DRIVE	2 IN HEX	UNIVERSAL SSL	1/2	307
810410N-9925	CS 62-48 AUGER DRIVE	2.5 IN HEX	UNIVERSAL SSL	3/4	433

EXCAVATOR MOUNT BUNDLES Hose routed out the side				
ORDER CODE	DESCRIPTION	OUTPUT SHAFT	MOUNT	SHIP WEIGHT (LBS)
810335N-E0852	CS 28-22 AUGER DRIVE	2.563 IN ROUND	C&P 027	278
810336N-E0852	CS 28-22 AUGER DRIVE	2 IN HEX	C&P 027	276
810340N-E0852	CS 35-25 AUGER DRIVE	2.563 IN ROUND	C&P 027	276
810341N-E0852	CS 35-25 AUGER DRIVE	2 IN HEX	C&P 027	276
810345N-E0852	CS 41-25 AUGER DRIVE	2.563 IN ROUND	C&P 027	278
810346N-E0852	CS 41-25 AUGER DRIVE	2 IN HEX	C&P 027	278
810335N-E0333	CS 28-22 AUGER DRIVE	2.563 IN ROUND	C&P 030	400
810336N-E0333	CS 28-22 AUGER DRIVE	2 IN HEX	C&P 030	398
810340N-E0333	CS 35-25 AUGER DRIVE	2.563 IN ROUND	C&P 030	398
810341N-E0333	CS 35-25 AUGER DRIVE	2 IN HEX	C&P 030	398
810345N-E0333	CS 41-25 AUGER DRIVE	2.563 IN ROUND	C&P 030	400
810346N-E0333	CS 41-25 AUGER DRIVE	2 IN HEX	C&P 030	400

AUGER BITS / EXTENSIONS

AGGRESSOR AUGERS							
STYLE	LENGTH	DIAMETER	HUB TYPE	NO. OF TEETH	WEIGHT	ORDER CODE	
Landscape Aggressor	30"	6"	2" Round	2	35 lbs	138400	
		9"	2" Round	4	42 lbs	138405	
		12"	2" Round	4	48 lbs	138410	
	36"	6"	2" Hex	2	34 lbs	243182	
		9"	2" Hex	4	44 lbs	243183	
		12"	2" Hex	4	48 lbs	243184	
		15"	2" Hex	5	57 lbs	243185	
		18"	2" Hex	6	67 lbs	243186	
		6"	2.56" Round	2	33 lbs	243187	
		9"	2.56" Round	4	43 lbs	243188	
		12"	2.56" Round	4	47 lbs	243189	
		15"	2.56" Round	5	56 lbs	243190	
		18"	2.56" Round	6	66 lbs	243191	
	48"	6"	2" Round	2	50 lbs	138010	
		9"	2" Round	4	58 lbs	138011	
		12"	2" Round	4	68 lbs	138012	
		15"	2" Round	5	78 lbs	138013	
		18"	2" Round	6	85 lbs	138014	
	Aggressor	36"	6"	2" Hex	2	39 lbs	236011
			9"	2" Hex	4	55 lbs	236012
12"			2" Hex	4	68 lbs	236013	
15"			2" Hex	5	73 lbs	236014	
18"			2" Hex	6	70 lbs	236015	
6"			2.56" Round	2	37 lbs	236016	
9"			2.56" Round	4	54 lbs	236017	
12"			2.56" Round	4	66 lbs	236018	
15"			2.56" Round	5	72 lbs	236019	
18"			2.56" Round	6	69 lbs	236020	
49"		6"	2" Hex	2	54 lbs	PNG104152	
		9"	2" Hex	4	78 lbs	PNG104153	
		6"	2.56" Round	2	54 lbs	PNG104168	
		9"	2.56" Round	4	78 lbs	PNG104169	
		12"	2" Hex	4	114 lbs	PNG104154	
51"	15"	2" Hex	5	117 lbs	PNG104155		
	18"	2" Hex	6	145 lbs	PNG104156		
	24"	2" Hex	8	210 lbs	PNG104157		
	30"	2" Hex	10	225 lbs	PNG104158		
	36"	2" Hex	12	295 lbs	PNG104159		
	12"	2.56" Round	4	114 lbs	PNG104170		
	15"	2.56" Round	5	117 lbs	PNG104171		
	18"	2.56" Round	6	145 lbs	PNG104172		
	24"	2.56" Round	8	210 lbs	PNG104173		
	30"	2.56" Round	10	225 lbs	PNG104174		
36"	2.56" Round	12	295 lbs	104175			
Tree Auger	51"	9"/18"	2" Hex	8	155 lbs	135554	
		12"/24"	2" Hex	9	160 lbs	135555	
		15"/30"	2" Hex	11	255 lbs	135556	
		18"/36"	2" Hex	13	290 lbs	135557	

AUGER BITS / EXTENSIONS

TRIMAX & SEVERE ROCK RIPPER AUGERS						
STYLE	LENGTH	DIAMETER	HUB TYPE	NO. OF TEETH	WEIGHT	ORDER CODE
TRIMAX	36"	6"	2" Hex	2	43 lbs	243192
		9"	2" Hex	4	51 lbs	243193
		12"	2" Hex	4	64 lbs	243194
		16"	2" Hex	6	85 lbs	243195
		18"	2" Hex	6	95 lbs	243196
		24"	2" Hex	8	98 lbs	243197
		30"	2" Hex	10	133 lbs	243198
		36"	2" Hex	12	171 lbs	243199
		6"	2.56" Round	2	42 lbs	243200
		9"	2.56" Round	4	50 lbs	243201
		12"	2.56" Round	4	63 lbs	243202
		16"	2.56" Round	6	84 lbs	243203
	18"	2.56" Round	6	94 lbs	243204	
	24"	2.56" Round	8	97 lbs	243205	
	30"	2.56" Round	10	132 lbs	243206	
	36"	2.56" Round	12	170 lbs	243207	
	6"	2" Hex	2	62 lbs	104091	
	9"	2" Hex	4	78 lbs	104093	
	12"	2" Hex	4	106 lbs	104095	
	16"	2" Hex	6	100 lbs	104097	
	18"	2" Hex	6	124 lbs	104098	
	24"	2" Hex	8	166 lbs	104100	
	30"	2" Hex	10	207 lbs	104101	
	36"	2" Hex	12	270 lbs	104102	
	48"	2" Hex	18	375 lbs	104104	
	6"	2.5" Hex	2	77 lbs	243230	
	9"	2.5" Hex	4	91 lbs	243231	
	12"	2.5" Hex	4	95 lbs	243232	
	16"	2.5" Hex	6	136 lbs	243233	
	18"	2.5" Hex	6	187 lbs	243234	
	24"	2.5" Hex	8	171 lbs	243235	
	30"	2.5" Hex	10	228 lbs	243236	
	36"	2.5" Hex	12	269 lbs	243237	
	6"	2.56" Round	2	61 lbs	104108	
	9"	2.56" Round	4	77 lbs	104110	
	12"	2.56" Round	4	105 lbs	104112	
16"	2.56" Round	6	99 lbs	104114		
18"	2.56" Round	6	123 lbs	104115		
24"	2.56" Round	8	165 lbs	104117		
30"	2.56" Round	10	206 lbs	104118		
36"	2.56" Round	12	269 lbs	104119		
Severe Rock Ripper	48"	6"	2" Hex	8	80 lbs	137950
		9"	2" Hex	10	108 lbs	137951
		12"	2" Hex	12	130 lbs	137952
		16"	2" Hex	15	170 lbs	137953
		18"	2" Hex	16	192 lbs	137954
		24"	2" Hex	20	285 lbs	137956
		30"	2" Hex	24	345 lbs	137957
		36"	2" Hex	26	415 lbs	137958

Single flight Trimax models available. Speak to your local representative for more information.
The SRR Auger comes standard with the S-RL08 conical teeth.

Replace with SR-76SW Strata® conical teeth for increased performance and life-cycle.

ANGLE BROOMS



The **Sweepster® Angle Sweeper** by Paladin, has a faceted hood design that provides maximum strength at the ends of the hood where most stress and damage occur.

- Available in 60”, 72” and 84” widths
- 32” diameter brush
- Quick change core

PART #	DESCRIPTION
22072MM-0022	72” MANUAL ANGLE BROOM SSL MOUNT
22084MM-0022	84” MANUAL ANGLE BROOM SSL MOUNT
22060MH-0022	60” HYDRAULIC ANGLE BROOM SSL MOUNT
22072MH-0022	72” HYDRAULIC ANGLE BROOM SSL MOUNT
22084MH-0022	84” HYDRAULIC ANGLE BROOM SSL MOUNT

PICK UP SWEEPERS



Sweepster® Skid Steer Loader Hydraulic Drive Collection Sweepers by Paladin handles light and heavy-duty clean up in construction, municipal and industrial applications. Narrower overall attachment width for improved mobility and cleanup in confined areas.

- Hydraulic pump feature*
- Waterless dust abatement system (WDA)

*Optional feature depending on model.

PART #	DESCRIPTION
21560M-0022	60” PICK UP SWEEPER SSL MOUNT
21572M-0022	72” PICK UP SWEEPER SSL MOUNT
21584M-0022	84” PICK UP SWEEPER SSL MOUNT
VRS5M-0022	60” PICK UP SWEEPER W/ HIGH DUMP AND FRONT CASTER SSL MOUNT
VRS6M-0022	72” PICK UP SWEEPER W/ HIGH DUMP AND FRONT CASTER SSL MOUNT
VRS7M-0022	84” PICK UP SWEEPER W/ HIGH DUMP AND FRONT CASTER SSL MOUNT
28-10136	SPRINKLER KIT 25 GALLON TANK 205/VRS/215 12V FACTORY INSTALL
28-9139	SPRINKLER KIT 25 GALLON TANK 205/VRS/215 12V FIELD INSTALL

BUCKETS

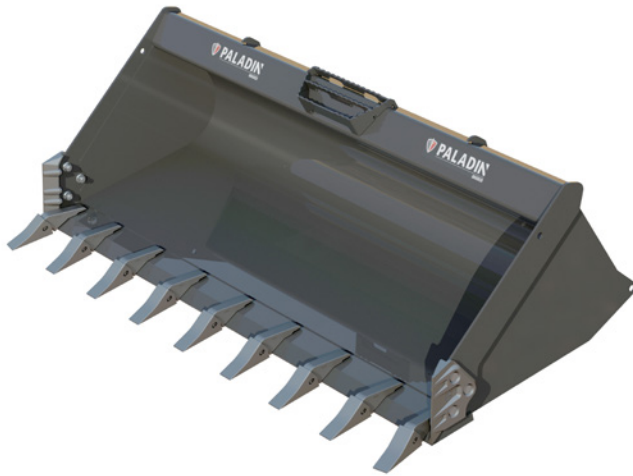

Bradco® Buckets by Paladin, are available in many styles, sizes and patterns to fit any need.

- Various sizes & edge hole patterns for common bolt-on wear edges available to assist in your jobs requirements
- High strength steel construction
- Standard tooth bars and tooth bars that fit over bolt-on wear edges available
- Tooth or smooth edge & bolt-on edges with series 23 H&L teeth available

LOW PROFILE BUCKETS WITH EDGE AND SIDE CUTTERS	
PART #	DESCRIPTION
KD15120	BUCKET, 60" LPSF,W/EDGE & SIDE CUTTERS
KD111813	BUCKET, 68" LPSF,W/EDGE & SIDE CUTTERS
KD113900	BUCKET, 72" LPSF,W/EDGE & SIDE CUTTERS
KD16270	BUCKET, 78" LPSF,W/EDGE & SIDE CUTTERS
KD16180	BUCKET, 84" LPSF,W/EDGE & SIDE CUTTERS

LOW PROFILE BUCKETS WITH TEETH AND SIDE CUTTERS	
PART #	DESCRIPTION
KD33861	BUCKET, 60" LPSF,W/TEETH & SIDE CUTTERS
KD111814	BUCKET, 68" LPSF,W/TEETH & SIDE CUTTERS
KD113901	BUCKET, 72" LPSF,W/TEETH & SIDE CUTTERS
KD16265	BUCKET, 78" LPSF,W/TEETH & SIDE CUTTERS
KD16190	BUCKET, 84" LPSF,W/TEETH & SIDE CUTTERS

POST DRIVER



The Bradco® Post Driver is designed to be operated with an SSL or CTL for driving posts up to 10 feet in length and up to 8 inches in diameter. Works with round or square posts; also compatible for recatangles such as guard rails. Quick change collars allow for changing from a smaller post collar to a larger one in a matter of minutes. Up to 30 hit a minute.

PART #	DESCRIPTION
111487	PD4800 POST DRIVER ONLY **MUST CHOOSE OPTIONS
112491	8.0in SQUARE COLLAR W/STRIKER PLATE ASSEMBLY
112920	108in HOSE KIT W/ 1/2in QC

GRAPPLE BUCKETS

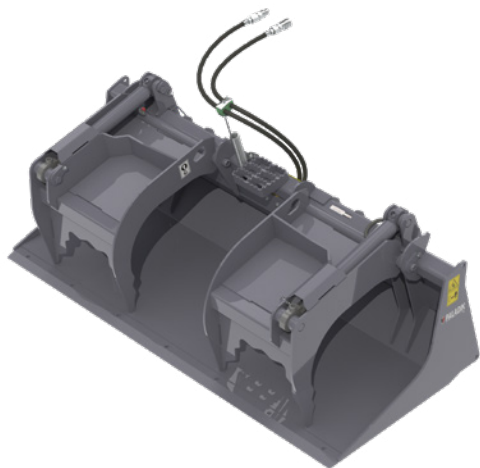

The **FFC® Brush and Scrap Grapples** by Paladin, have been designed to prevent the roll back interference that occurred on some newer models of skid steer loaders and also offers hose length options.

- Patented design withstands the demands of work in scrap handling, recycling, and other tough applications
- Full feature includes hardened pins, cushioned cylinder kit, and cylinder/hose guard for model 120

PART #	DESCRIPTION
123668	60" STANDARD DUTY SCRAP GRAPPLE W/ BOE (12860-0022) SSL MOUNT INCLUDES 88" HOSE KIT, 90 DEG CPL, & HOSE SAVER (103179)
123669	66" STANDARD DUTY SCRAP GRAPPLE W/ BOE (12866-0022) SSL MOUNT INCLUDES 88" HOSE KIT, 90 DEG CPL, & HOSE SAVER (103179)
123670	72" STANDARD DUTY SCRAP GRAPPLE W/ BOE (12872-0022) SSL MOUNT INCLUDES 88" HOSE KIT, 90 DEG CPL, & HOSE SAVER (103179)
123671	76" HEAVY DUTY SCRAP GRAPPLE W/ BOE (11876-0022) SSL MOUNT INCLUDES 88" HOSE KIT, 90 DEG CPL, & HOSE SAVER (103179)
123672	82" HEAVY DUTY SCRAP GRAPPLE W/ BOE (11882-0022) SSL MOUNT INCLUDES 88" HOSE KIT, 90 DEG CPL, & HOSE SAVER (103179)
32060-0022	60" STANDARD-DUTY BRUSH GRAPPLE SSL MOUNT INCLUDES 88" HOSE KIT, & 1/2" 90 DEG CPL
32066-0022	66" STANDARD-DUTY GRAPPLE SSL MOUNT INCLUDES 88" HOSE KIT, & 1/2" 90 DEG CPL
32072-0022	72" STANDARD-DUTY GRAPPLE SSL MOUNT INCLUDES 88" HOSE KIT, & 1/2" 90 DEG CPL
32084-0022	84" STANDARD-DUTY GRAPPLE SSL MOUNT INCLUDES 88" HOSE KIT, & 1/2" 90 DEG CPL
32172-0022	72" HEAVY-DUTY BRUSH GRAPPLE SSL MOUNT INCLUDES 88" HOSE KIT, & 1/2" 90 DEG CPL
32178-0022	78" HEAVY-DUTY BRUSH GRAPPLE SSL MOUNT INCLUDES 88" HOSE KIT, & 1/2" 90 DEG CPL
32184-0022	84" HEAVY-DUTY BRUSH GRAPPLE SSL MOUNT INCLUDES 88" HOSE KIT, & 1/2" 90 DEG CPL
ROOT RAKE, SKID STEER LOADER	
31972-0022	72" ROOT RAKE UNIV SSL MOUNT W/ 85" HOSES & 1/2" QD's
31978-0022	78" ROOT RAKE UNIV SSL MOUNT W/ 85" HOSES & 1/2" QD's
31984-0022	84" ROOT RAKE UNIV SSL MOUNT W/ 85" HOSES & 1/2" QD's

MULTI-PURPOSE BUCKET (4-IN-1)



The **Bradco® 4-in-1 Multipurpose Bucket** functions as a loader bucket, clam, grapple, dozer, box scraper and bottom dump bucket.

- Made of lightweight material with heavy duty hinges and pins
- Evenly distributes the load and provides the ability to handle more load capacity

PART #	DESCRIPTION
108022	72" 4IN1 SKID STEER BUCKET (HEAVY DUTY), CHOOSE BOE & HOSE KIT
108024	78" 4IN1 SKID STEER BUCKET (HEAVY DUTY), CHOOSE BOE & HOSE KIT
108026	84" 4IN1 SKID STEER BUCKET (HEAVY DUTY), CHOOSE BOE & HOSE KIT
108023	72" 4IN1 SKID STEER BUCKET WITH TEETH (HEAVY DUTY), CHOOSE HOSE KIT
108025	78" 4IN1 SKID STEER BUCKET WITH TEETH (HEAVY DUTY), CHOOSE HOSE KIT
108027	84" 4IN1 SKID STEER BUCKET WITH TEETH (HEAVY DUTY), CHOOSE HOSE KIT
103577	HOSE KIT FOR 4IN1 BUCKET
15028	72" BOLT ON EDGE FOR 4IN1 BUCKET
16204	78" BOLT ON EDGE FOR 4IN1 BUCKET
16183	84" BOLT ON EDGE FOR 4IN1 BUCKET

AUTORAKE®



FFC® AutoRake® by Paladin, an easy to use site clean-up and soil preparation attachment. This unit can be mounted on three-point configuration (tractor) and is excellent for picking up windrows in support of power box rake operations.

PART #	DESCRIPTION
LAF6864-0022	66" AUTORAKE UNIV SSL MOUNT
LAF6874-0022	76" AUTORAKE UNIV SSL MOUNT

LANDSCAPE RAKES



Harley® and FFC® Power Rakes, by Paladin, are the highest quality, most durable and versatile power rakes available. They are widely regarded as the “gold standard” for power rakes by landscaping professionals. These rakes have been engineered to create the most optimal seedbed conditions leading to lush grass and beautiful landscaping.

PART #	DESCRIPTION
LANDSCAPE RAKES, SKID STEER LOADER	
25260M-0022	5' MANUAL ANGLE HARLEY RAKE, SSL
25272H-0022	6' HYDRAULIC ANGLE HARLEY RAKE, SSL
25284H-0022	7' HYDRAULIC ANGLE HARLEY RAKE, SSL
25296H-0022	8' HYDRAULIC ANGLE HARLEY RAKE, SSL
LAF5672-0022	72" MANUAL ANGLE DIRECT DRIVE POWER RAKE, SSL
LAF5690H-0022	90" HYDRAULIC ANGLE DIRECT DRIVE POWER RAKE, SSL
LANDSCAPE RAKES, TRACTOR 3-POINT	
T6M-0052	6' MANUAL ANGLE TRACTOR 3 POINT HARLEY RAKE
T6H-0052	6' HYDRAULIC ANGLE TRACTOR 3 POINT HARLEY RAKE

GROUND SHARK BRUSH CUTTERS

STANDARD DUTY (SD)



SD FEATURES

- The Ground Shark® Standard Duty Brush Cutter is designed to clear light to medium density brush and hardwoods up to 4" diameter. The Ground Shark direct drive system runs efficiently, smooth and quiet while cutting the toughest material. Low-profile design slips easily under fences. The perfect general purpose brush cutter for routine land maintenance.

HEAVY DUTY (HD)



HD FEATURES

- Designed to clear medium to heavy brush and hardwoods up to 7" in diameter. When the exclusive, patented retractable forward shield comes in contact with a tree, it moves up and back to expose the entire cutting edge of each blade while protecting the operator from flying debris.

HIGH PERFORMANCE (HP)



HP FEATURES

- The High Performance Brush Cutters offer a robust solution for clearing medium-to-heavy brush and hardwoods up to 10" in diameter. Both models include a radial piston direct drive motor for higher efficiency and extended durability, while an optimized blade carrier design allows for a fast startup and recovery time.

EXTREME DUTY (XD)



XD FEATURES

- The Ground Shark® Extreme Duty High Flow Brush Cutters are designed for clearing medium to heavy density brush and hardwoods up to 10" in diameter from wooded acreages, road right-of-ways, and pipeline maintenance. When the exclusive, patented retractable forward shield comes in contact with a tree, it moves up and back to expose the entire cutting edge of each blade while protecting the operator from flying debris.

GROUND SHARK BRUSH CUTTERS

PART #	DESCRIPTION
30360A-0022	60" STANDARD DUTY (SD) BRUSH CUTTER, 15-25 GPM, 1/2" QDs
30372A-0022	72" STANDARD DUTY (SD) BRUSH CUTTER, 15-25 GPM, 1/2" QDs
30378A-0022	78" STANDARD DUTY (SD) BRUSH CUTTER, 15-25 GPM, 1/2" QDs
31766-0022	66" HEAVY DUTY (HD) BRUSH CUTTER, 20-34 GPM, 1/2" QDs
31772-0022	72" HEAVY DUTY (HD) BRUSH CUTTER, 20-34 GPM, 1/2" QDs
31766-9925	66" HEAVY DUTY (HD) BRUSH CUTTER, 20-34 GPM, 3/4" QDs
31772-9925	72" HEAVY DUTY (HD) BRUSH CUTTER, 20-34 GPM, 3/4" QDs
31766-9903	66" HEAVY DUTY (HD) BRUSH CUTTER, 20-34 GPM, 5/8" QDs
31772-9903	72" HEAVY DUTY (HD) BRUSH CUTTER, 20-34 GPM, 5/8" QDs
31872-0022	72" HIGH PERFORMANCE (HP) BRUSH CUTTER, 30-45 GPM, 1/2" QDs
31872-9903	72" HIGH PERFORMANCE (HP) BRUSH CUTTER, 30-45 GPM, 5/8" QDs
31872-9925	72" HIGH PERFORMANCE (HP) BRUSH CUTTER, 30-45 GPM, 3/4" QDs
31884-0022	84" HIGH PERFORMANCE (HP) BRUSH CUTTER, 30-45 GPM, 1/2" QDs
31884-9903	84" HIGH PERFORMANCE (HP) BRUSH CUTTER, 30-45 GPM, 5/8" QDs
31884-9925	84" HIGH PERFORMANCE (HP) BRUSH CUTTER, 30-45 GPM, 3/4" QDs
30272-0022	72" EXTREME DUTY (XD) BRUSH CUTTER, 30-45 GPM, 1/2" QDs
30278-0022	78" EXTREME DUTY (XD) BRUSH CUTTER, 30-45 GPM, 1/2" QDs
30272-9925	72" EXTREME DUTY (XD) BRUSH CUTTER, 30-45 GPM, 3/4" QDs
30278-9925	78" EXTREME DUTY (XD) BRUSH CUTTER, 30-45 GPM, 3/4" QDs
30272-9903	72" EXTREME DUTY (XD) BRUSH CUTTER, 30-45 GPM, 5/8" QDs
30278-9903	78" EXTREME DUTY (XD) BRUSH CUTTER, 30-45 GPM, 5/8" QDs

CUTTING BLADES

118330	STANDARD DUTY 60"
118331	STANDARD DUTY 72"
118332	STANDARD DUTY 78"
123735	HEAVY DUTY 66"
123736	HEAVY DUTY 72"
124686	HIGH PERFORMANCE 72", 84"
117194	EXTREME DUTY 72", 78"

CARBIDE STUMP GRINDING TEETH

123781	HEAVY DUTY 66"
123733	HEAVY DUTY 72"
117193	EXTREME DUTY 72"
123734	EXTREME DUTY 78"

SKID SHOE KIT

117810	STANDARD DUTY 60", 72", 78"
123544	HEAVY DUTY 66"
117192	HEAVY DUTY 72"
117192	HIGH PERFORMANCE 72"
123343	HIGH PERFORMANCE 84"
117192	EXTREME DUTY 72"
123639	EXTREME DUTY 78"

DUAL WHEEL KIT

118333	STANDARD DUTY 60", 72", 78"
--------	-----------------------------

MULCHPOWER GAUGE

117824	STANDARD DUTY 60", 72", 78"
123642	HEAVY DUTY 66", 72"
INCLUDED	HIGH PERFORMANCE 72", 84"
INCLUDED	EXTREME DUTY 72", 78"

CONCRETE CHUTER



The FFC® Concrete Chuter is designed for accurate placement of concrete in tight spaces on job sites where cement trucks can't go. Never wheelbarrow or pump concrete again!

PART #	DESCRIPTION
11050-0022	½ YD CONCRETE CHUTER W/HOSES
11075-0022	¾ YD CONCRETE CHUTER W/HOSES

CONCRETE CLAW



The FFC® Concrete Claw, is ruggedly designed for removing concrete sidewalks and driveways or on any construction site and can be used for shrub and stump removal.

PART #	DESCRIPTION
10024-0022	CONCRETE CLAW, SSL MOUNT

MULCHERS - DRUM STYLE



- Shreds up to 8" diameter hardwood trees
- Patented tooth design and easily interchangeable tooth design options
- Replaceable abrasion resistant AR400 wear plate on skid shoes
- Deflector door standard to control particle size and discharge direction
- Reversible teeth double the useful life vs. single-edge styles

PART #	DESCRIPTION
124171*	60" DRUM MULCHER, CLAW TEETH, 30-45 GPM
125346*	60" DRUM MULCHER, REVERSIBLE CARBIDE HAMMERS, 30-45 GPM
124652*	72" DRUM MULCHER, CLAW TEETH, 30-45 GPM
126008*	72" DRUM MULCHER, REVERSIBLE CARBIDE HAMMERS, 30-45 GPM
* Includes Standard Control Kit and 3/8" Female Case Drain; Requires Hoses	
HOSE KITS (REQUIRED)	
233133	80" HOSES WITH 1/2" QDs
233134	80" HOSES WITH 5/8" QDs
110915	80" HOSES WITH 3/4" QDs
84923*	3/8" MALE CASE DRAIN COUPLER*
*Required for Case/CNH Machines	
REPLACEMENT TEETH	
116092	60" DRUM STYLE, REVERSIBLE CLAW TEETH KIT
112578	72" DRUM STYLE, REVERSIBLE CLAW TEETH KIT
116091	60" DRUM STYLE, REVERSIBLE CARBIDE HAMMER KIT
111794	72" DRUM STYLE, REVERSIBLE CARBIDE HAMMER KIT
STANDARD CONTROL KIT	
LAF9360-0000	KUBOTA, CASE, TAKEUCHI, NEW HOLLAND, VOLVO, JCB
OPTIONAL CONTROL KIT	
07-9548	BOBCAT 2012+
119741	CAT XHP D
119740	CAT XPS D
07-7626	JOHN DEERE EH
LAF9361-0000	JOHN DEERE F
07-10170	KOMATSU
OIL COOLERS	
115851	MM60 SERIES II FACTORY INSTALLED
115852	MM60 SERIES II DEALER INSTALLED
115853	MM72 SERIES II FACTORY INSTALLED
115854	MM72 SERIES II DEALER INSTALLED

MULCHERS - DISK STYLE



- Designed to reduce jamming
- Ultra-efficient drive system with fast start
- MulchPower™ Gauge for maximum energy
- Bearing housing never needs to be greased
- Debris shovel keeps teeth out of the dirt and guides material for processing
- High-quality QUADCO teeth are interchangeable, allowing for simple service and rotation
- Fells trees up to 14"
- Processes up to 8"
- Stump grinds to grade

PART #	DESCRIPTION
125260-0022	60" FORESTRY DISC MULCHER, 1/2" QD, 3/8" CASE DRAIN, 30-45 GPM
125260-9903	60" FORESTRY DISC MULCHER, 5/8" QD, 3/8" CASE DRAIN, 30-45 GPM
125260-9925	60" FORESTRY DISC MULCHER, 3/4" QD, 3/8" CASE DRAIN, 30-45 GPM
CONSUMABLES AND REPLACEMENTS	
125288	PARTIAL TOOTH REPLACEMENT KIT (20 TEETH AND HARDWARE)
125984	RIGHT-SIDE SKID SHOE REPLACEMENT KIT
125985	LEFT-SIDE SKID SHOE REPLACEMENT KIT
125986	DEBRIS SHOVEL REPLACEMENT KIT
125959	SWINGING DEBRIS DOOR REPLACEMENT KIT

DOZER BLADE



Bradco® Dozer Blade by Paladin, with tilt attach, tilts the dozer blade for more precise grading, leveling and trenching. This means that you get to the next job quicker!

- Hydro-electric controlled angle and tilt, using only one loader valve
- Angle 30° right or left of center
- Tilt 10° off horizontal both directions
- Tilt indicator visible from operator's seat

PART #	DESCRIPTION
88861	7' DOZER BLADE, SSLMOUNT, ADD CONTROL BOX 15756 or SPECIFIC HARNESS
89681	8' DOZER BLADE, SSL MOUNT, ADD CONTROL BOX 15756 or SPECIFIC HARNESS
15756	UNIVERSAL CONTROL BOX, 12V

STUMP GRINDER



The **Bradco® Stump Grinder** by Paladin, is available in standard and high flow. The standard flow model has a 26" diameter cutting wheel allowing up to 10" of below ground cutting. and the high flow model has a 30" wheel allowing up to 12" of below ground cutting.

- Tooth pattern permits cutting from side-to-side and vertical directions
- Wheel and tooth options available
- Heavy-duty gearbox drives with torque arm motor support for longer motor and drive system life
- Easy access to all drive components allows for quick maintenance

PART #	DESCRIPTION
100319	STUMP GRINDER SG26, STANDARD FLOW ** MUST ORDER WHEEL, HOSES, & CONTROLS
101234	WHEEL ASSEMBLY, SQUARE TEETH
100984	HOSE KIT, 88", 1/2" QD
104367	UNIVERSAL CONTROL BOX, STUMP GRINDER

TRENCHERS



Bradco® Trenchers by Paladin, can mount to skid-steer loaders, compact skid-steer loaders and 3-point PTO HP hydrostatic tractors. Several boom lengths are available to match your job's specifications.

- Standard flow and high flow options are available
- Choose from various chain and teeth assemblies

PART #	DESCRIPTION
117765	TRENCHER ASSY, 48" BOOM X 6" CHAIN (CUP TOOTH EVERY STATION), SSL MOUNT W/ 97" HOSE KIT
117766	TRENCHER ASSY, 48" BOOM X 6" CHAIN (70/30 TOOTH EVERY STATION), SSL MOUNT W/ 97" HOSE KIT

COLD PLANERS



The **Bradco® Cold Planers** by Paladin, is an effective tool for small milling jobs, as well as asphalt and concrete pothole and frost heave repair, curb cutting, pavement texturing and removal of traffic lane stripes and roadway around manholes.

The **FFC® Asphalt Mills** by Paladin, can be used to make full depth utility cuts, mill frost heaves around manholes, restore proper drainage to pavement, add texture to pavement for skid resistance, and more.

PART #	DESCRIPTION
COLD PLANERS STANDARD FLOW SKID STEER LOADER	
101196	12" COLD PLANER STANDARD FLOW HYD SIDE-SHIFT
ASPHALT MILLS SKID STEER LOADER	
LAF5413-0022	16" COLD PLANER STD FLOW 3-LINE SSL MOUNT
LAF5424-0022	24" COLD PLANER HIGH FLOW 3-LINE SSL MOUNT W/ CONTROL BOX

PALLET FORKS



Bradco® Pallet Forks feature heavy-duty frames designed to handle up to 6,200 lb. fork capacities without taxing the loader’s power or lift capacity.

- Lever style locks provide additional leverage when operating the tine latching mechanism
- Excellent see through visibility allows the operator to see the ends
- Custom branded fork carriage available

PART #	DESCRIPTION
30945-0022	PALLET FORK FRAME ONLY SSL MOUNT
67604	48" 4000# CAPACITY FORKS (PAIR)

SHARKBITE™ GRAPPLE



SharkBite™ installs onto any ISO-standard class II ITA fork rail, transforming a regular set of pallet forks into an ultra-versatile grapple. Optional bolt-on Shark Teeth extend the durability and gripping performance of SharkBite, and the high-strength steel construction and powder-coat finish means SharkBite is built to last.

PART #	DESCRIPTION
233180	SHARKBITE ASSEMBLY - FORK AND FRAME SOLD SEPERATELY
233215	OPTIONAL REVERSIBLE AR400 HARDENED TEETH (QTY 6 - FIELD INSTALL)

SNOW PUSH



The **FFC Snow Push**, by Paladin is engineered of heavy-duty, fully welded steel with 3/8" thick end plates to capture and remove even the heaviest snow without leaving windrows or spillover. For SSL, Compact Utility Loaders, Small Wheel Loaders and Backhoe Loaders.

PART #	DESCRIPTION
23296-0022	8' LOW PROFILE SNOW PUSH SSL MOUNT
23220-0022	10" LOW PROFILE SNOW PUSH SSL MOUNT
23320-0022	10" 3' X 3' SNOW PUSH SSL MOUNT

ICESHARK™ 250 SERIES SNOW BLOWERS



FEATURES

- The new patented backdrag options allows operators to remove snow as close as 6" from a garage or wall to minimize the amount of shoveling required
- The built in yellow indicators guide users as they get close to a structure and give the operator guidance before engaging the backdrag functionality
- The new 3D floating hitch offers side to side, up and down, and front to back motion to allow the snow blower to have the smoothest operating experience when working on uneven surfaces
- The 3D floating hitch also allows for an uninterrupted scrape offering a cleaner surface which means less salt is required
- The dual articulating shoot offering unprecedented user control on where to place the snow with the 270 degrees of motion and ability to blow snow from as close as 3 feet or up to 45 feet
- The skid skis offer toolless adjustment which enable users to quickly and easily transition from gravel to pavement

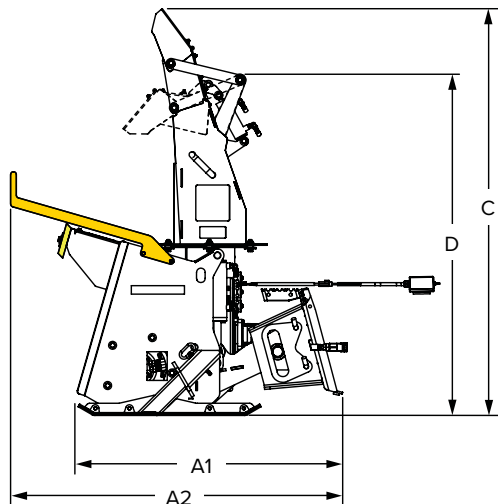
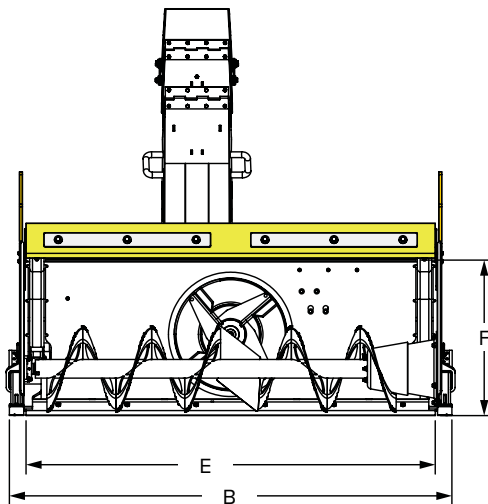

ICESHARK SNOW BLOWERS SPECIFICATIONS	COMPACT & STANDARD FLOW				HIGH FLOW	
	48"	60"	72"	84"	72"	84"
A1. OVERALL LENGTH WITHOUT BACKDRAG	46"	46"	46"	46"	49.3"	49.3"
A2. OVERALL LENGTH WITH BACKDRAG*	-	57.8"	57.8"	57.8"	61.3"	61.3"
B. OVERALL WIDTH	53"	65"	77"	89"	77"	89"
C. MAXIMUM OVERALL HEIGHT	71"	71"	71"	71"	78"	78"
D. MINIMUM OVERALL HEIGHT	60"	60"	60"	60"	65.75"	65.75"
E. CUTTING WIDTH	48"	60"	72"	84"	72"	84"
F. CUTTING HEIGHT	27.5"	27.5"	27.5"	27.5"	34"	34"
HYDRAULIC PRESSURE	3500 PSI				4200 PSI	

*BACKDRAG NOT AVAILABLE IN 48" MODELS

ICESHARK™ 250 SERIES SNOW BLOWERS

PART #	DESCRIPTION
25048B-0022	48" COMPACT FLOW SNOW BLOWER, 8-15 GPM, NO BACKDRAG
25060D-0022	60" STANDARD FLOW SNOW BLOWER, 15-27 GPM, NO BACKDRAG
25060DBD-0022	60" STANDARD FLOW SNOW BLOWER, 15-27 GPM, BACKDRAG INCLUDED
25072D-0022	72" STANDARD FLOW SNOW BLOWER, 15-27 GPM, NO BACKDRAG
25072DBD-0022	72" STANDARD FLOW SNOW BLOWER, 15-27 GPM, BACKDRAG INCLUDED
25084D-0022	84" STANDARD FLOW SNOW BLOWER, 15-27 GPM, NO BACKDRAG
25084DBD-0022	84" STANDARD FLOW SNOW BLOWER, 15-27 GPM, BACKDRAG INCLUDED
25072F-0022	72" HIGH FLOW SNOW BLOWER, 27-35 GPM, NO BACKDRAG
25072FBD-0022	72" HIGH FLOW SNOW BLOWER, 27-35 GPM, BACKDRAG INCLUDED
25084F-0022	84" HIGH FLOW SNOW BLOWER, 27-35 GPM, NO BACKDRAG
25084FBD-0022	84" HIGH FLOW SNOW BLOWER, 27-35 GPM, BACKDRAG INCLUDED
25072H-0022	72" EXTRA HIGH FLOW SNOW BLOWER, 35-45 GPM, NO BACKDRAG
25072HBD-0022	72" EXTRA HIGH FLOW SNOW BLOWER, 35-45 GPM, BACKDRAG INCLUDED
25084H-0022	84" EXTRA HIGH FLOW SNOW BLOWER, 35-45 GPM, NO BACKDRAG
25084HBD-0022	84" EXTRA HIGH FLOW SNOW BLOWER, 35-45 GPM, BACKDRAG INCLUDED
REPLACEMENT AND OPTIONAL CONTROLS	
LAF9394-0000	REPLACEMENT INDEPENDENT CONTROL BOX, POWER FROM MACHINE BATTERY (INCLUDED IN -0022 MODELS)
07-9548	WIRE HARNESS FOR INTEGRATED MACHINE CONTROLS, 7-PIN, FITS ALL SERIES 2012+, FOR BOBCAT
07-10021	WIRE HARNESS FOR INTEGRATED MACHINE CONTROLS, 8-PIN, FITS ALL SERIES, FOR CAT PRE-B
07-10122	WIRE HARNESS FOR INTEGRATED MACHINE CONTROLS, 8-PIN, FITS A-E SERIES, FOR CAT B AND C
07-10170	WIRE HARNESS FOR INTEGRATED MACHINE CONTROLS, 8-PIN, FITS F2-H SERIES, FOR CAT B AND C
07-8344	WIRE HARNESS FOR INTEGRATED MACHINE CONTROLS, 14-PIN, FITS A-E SERIES, FOR CAT D
LAF9360-0000	WIRE HARNESS FOR INTEGRATED MACHINE CONTROLS, 14-PIN, FITS ALL SERIES, FOR BOBCAT / KUBOTA (W MULTI-FUNCTION IN CAB CONTROLS) / CNH / JCB
LAF9393	WIRE HARNESS FOR INTEGRATED MACHINE CONTROLS, 8-PIN, FITS ALL SERIES, FOR CNH
07-7338	WIRE HARNESS FOR INTEGRATED MACHINE CONTROLS, 3-PIN, FITS ALL SERIES, FOR JOHN DEERE
LAF9361	WIRE HARNESS FOR INTEGRATED MACHINE CONTROLS, 14-PIN, FITS ALL SERIES, FOR JOHN DEERE-8 BUTTON
07-7626	WIRE HARNESS FOR INTEGRATED MACHINE CONTROLS, 14-PIN, FITS ALL SERIES, FOR JOHN DEERE EH CONTROL
07-10194	WIRE HARNESS FOR INTEGRATED MACHINE CONTROLS, 14-PIN, FITS ALL SERIES, FOR KOMATSU
07-10057	WIRE HARNESS FOR INTEGRATED MACHINE CONTROLS, 8-PIN, FITS ALL SERIES, FOR KOMATSU
OPTIONAL BACKDRAG KITS	
28-11225-60	60" STANDARD FLOW
28-11225-72	72" STANDARD FLOW
28-11225-84	84" STANDARD FLOW
28-11219-72	72" HIGH FLOW, 72" EXTRA HIGH FLOW
28-11219-84	84" HIGH FLOW, 84" EXTRA HIGH FLOW
DUAL WHEEL KIT	
28-11300-48	48" STEEL EDGE KIT, INCLUDES HARDWARE
28-1130-60	60" STEEL EDGE KIT, INCLUDES HARDWARE
28-11300-72	72" STEEL EDGE KIT, INCLUDES HARDWARE
28-11300-84	84" STEEL EDGE KIT, INCLUDES HARDWARE
28-11301-48	48" POLYURETHANE EDGE KIT, INCLUDES HARDWARE
28-11301-60	60" POLYURETHANE EDGE KIT, INCLUDES HARDWARE
28-11301-72	72" POLYURETHANE EDGE KIT, INCLUDES HARDWARE
28-11301-84	84" POLYURETHANE EDGE KIT, INCLUDES HARDWARE
28-11312	STEEL WEAR SHOE KIT, INCLUDES HARDWARE
28-11313	SOFT WEAR SHOE KIT, INCLUDES HARDWARE

MINI BUCKETS



Bradco® Mini Buckets are available with Toro/Dingo, ASV and Bobcat MT Series mounts. Bucket widths 42" (4 and 6 cu. ft. capacity) and 48" (4 and 6 cu. ft. capacity). Buckets available with weld-on teeth or tooth bars.

PART #	DESCRIPTION
SMOOTH BUCKET, MINI SKID STEER UNIVERSAL MOUNT	
117506	36" (4 FT ³) SMOOTH BUCKET, MINI SSL
2000872	42" (4 FT ³) SMOOTH BUCKET, MINI SSL
107783	44" (7 FT ³) SMOOTH LIGHT MATERIAL BUCKET, MINI SSL
2000877	48" (6 FT ³) SMOOTH BUCKET, MINI SSL
TOOTH BUCKET, MINI SKID STEER UNIVERSAL MOUNT	
119300	36" (4 FT ³) TOOTH BUCKET, MINI SSL
19405	42" (4 FT ³) TOOTH BUCKET, MINI SSL
104579	48" (6 FT ³) TOOTH BUCKET, MINI SSL

MINI GRAPPLES



- The brush grapple is ideally suited for moving brush, limbs and branches. The open tine design allows the vegetative material to be moved while allowing soil to drop through and remain behind
- The solid floor scrap grapple make it the ideal mini skid steer tool for scrap and yard waste removal and construction sites, especially in tight areas

PART #	DESCRIPTION
BRUSH GRAPPLE, MINI SKID STEER UNIVERSAL MOUNT	
107036	42" BRUSH GRAPPLE, MINI SSL
107037	48" BRUSH GRAPPLE, MINI SSL
SCRAP GRAPPLE, MINI SKID STEER UNIVERSAL MOUNT	
107148	42" SCRAP GRAPPLE, MINI UNIVERSAL SSL MOUNT
123978	48" SCRAP GRAPPLE, MINI UNIVERSAL SSL MOUNT
HARDSCAPE GRAPPLE MINI SKID STEER	
23548-0961	HARDSCAPE GRAPPLE - MINI SSL

MINI TRENCHERS

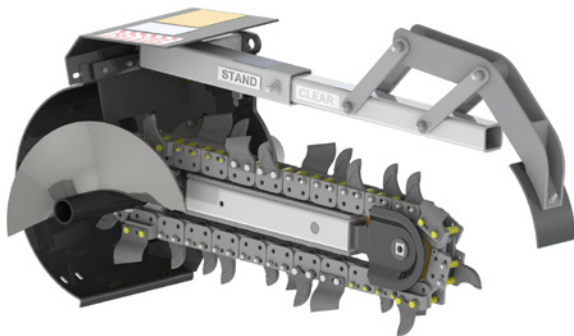

- 24", 30", 36" & 48" digging depths
- 6" to 12" wide chains available
- Operating pressure (psi) 2,000 to 3,000
- GPM requirements 6-10 or 10-16
- Standard tooth, shark tooth, or combo available

PART #	DESCRIPTION
118618	TRENCHER, 615,10-16 GPM 30" BOOM, 6.0" 70/30, MINI SSL
118621	TRENCHER, 615,10-16 GPM 36" BOOM, 4.5" 70/30, MINI SSL
113344	TRENCHER, 615,10-16 GPM 36" BOOM, 6.0" 70/30, MINI SSL

MINI LANDSCAPE RAKE



- Direct drive motor is embedded within frame and drum providing optimal protection from dirt and debris.
- Adjustable Rhino-Hide barrier
- Specially shaped and placed carbide teeth ensure the best possible seedbed
- Easily removable end plates

PART #	DESCRIPTION
22748M-0961	48" HARLEY RAKE MANUAL ANGLE MINI SSL
22748H-0961	48" HARLEY RAKE HYDRAULIC ANGLE MINI SSL

MINI PALLET FORKS



- Adjustable tine widths
- Heavy-duty, easy on and off

PART #	DESCRIPTION
108366	PALLET FORKS, MINI SKID STEER UNIVERSAL MOUNT
106220	42" PALLET FORKS FOR 108366
106222	48" PALLET FORKS FOR 108366

CS SERIES AUGER DRIVE UNITS

- Hunting gearing as standard for increased life and efficiency
- Secure lock shaft
- Compact housing design for easy handling and increased strength and durability
- Oversized bearing for improved load handling
- Extreme shaft seals for reduced service intervals
- Compact, high torque, efficient hydraulic motors for improved drilling productivity
- Easy access service points for user friendly maintenance
- Full connection contact between auger hub and auger drive unit

CTC MOUNT BUNDLES

Hose routed out the side

ORDER CODE	DESCRIPTION	OUTPUT SHAFT	MOUNT	QD INCLUDED	SHIP WEIGHT (LBS)
810237N-0961	CS 16-15 AUGER DRIVE	2.563 IN ROUND	CII	1/2	181
810238N-0961	CS 16-15 AUGER DRIVE	2 IN HEX	CII	1/2	181
810243N-0961	CS 20-17 AUGER DRIVE	2.563 IN ROUND	CII	1/2	181
810244N-0961	CS 20-17 AUGER DRIVE	2 IN HEX	CII	1/2	181

MINI TILLERS



- Replaceable and reversible tines
- Adjustable depth guide
- 8 to 15 GPM recommended
- 1,500 to 3,000 operating pressure (PSI)

PART #	DESCRIPTION
2008000	40" TILLER, MINI SSL





















MINI STUMP GRINDER







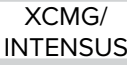













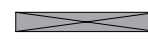

- Bearing mounted cutting wheel provides smooth, trouble-free operation
- Adjustable wheel cutting angle allows optimal cutting for any type of stump

PART #	DESCRIPTION
101866	STUMP GRINDER, MINI, 10 to 14 GPM (MUST SELECT MOUNT, WHEEL, & HOSES)
101868	UNIVERSAL MINI MOUNT (NON BOBCAT) FOR STUMP GRINDER
104374	BOBCAT MOUNT FOR STUMP GRINDER
101876	WHEEL ASSEMBLY W/BOLT ON TEETH
101874	HOSE KIT, FLAT FACE

MINI / BACKHOE / EXCAVATORS MACHINE CLASSIFICATION

METRIC TON CLASS	01mT	02mT	03mT	05mT	08mT	12mT	15mT		
BACKHOE CLASS			BH <13'		BH 13'-17'		BH>17'		
CLASS	100 MINI	200 MINI	300 MINI	400 MINI	10	20	710	25	35
CWS CLASS		BE15	BE30	BE40	BE60	BE80		HE120	HE150
RANGE						R3	R4	R4	R5
 Bobcat	E10	E20	E26**, E32, E32i, E35, E35i	E42, E45, E50 E55, E63		E85		E145	
 CASE		CX17B, CX17C	CX26C**, CX30C, CX31B, CX33C, CX36B, CX37C	CX55B, CX57C, CX60C	580N, 580SN, 580SNWT, 590N, 590SN	CX75C SR, CX80C		CX140E, CX130D, CX135C CS, CX145C SR, CX145D SR	CX160D, CX170E, CX190E
 CAT	300.9D	301.4C, 301.5, 301.7D, 301.7 CR, 301.8, 302 CR	302.4D**, 302.7C/DCR**, 303ECR, 303.5ECR	304ECR, 304.5ECR, 305ECR, 305.5ECR, 306CR	415F2, 416F2, 420F2, 430F2	307E, 307.5, 308ECR, 309CR, 310	450F	311F, 312E, 313F, 314E, 315F	315D, 316E/F, 318E/F
DEVELON			DX35-5	DX42-5, DX55-5, DX60-3, DX62R-3, DX63-3		DX85R-3		DX140-3/5, DX140LCR-3/5, DX140W-5	DX160, DX170-5, DX180-3/5, DX190, DX190W-5
 GEHL		Z17	Z25**, Z35	Z45, Z55		Z80			
 HITACHI		ZX17U-5	ZX26U-5**, ZX30U-5, ZX35U-5"	ZX50U-5, ZX60USB-5		ZX75US-5/7, ZX85USB-5/7		ZX130-6/7, ZX135US-6/7	ZX160-6/7
 HYUNDAI		R17Z-9A	R25Z-9AK**, R30Z-9AK, R35Z-9A	R55-9A, R55W-9A, R60CR-9A		R80CR-9A, R110-7		R125-9A, HX130LCR, R140W-9A, R140-9A, HX140L, HW140, R145-9A, HX145L	R160-9A, R180-9A, R180W-9A, HX160L, HX180L, HW180
IHI/KATO	9VX, 9VXE, HD9V, HD9VX	17VX, 17VXE, HD17V, HD17VXE	25V-4**, HD25V4**, 30V-4, HD30V4, 35N-4, HD55N4, 35V-4, HD35N4	45V-4, HD45V4, 55V-4, HD55V4, 65V-4, HD65V4	55N-4, HD55N4	85V-4, HD85V4		HD512-7, HD514MR-7	
 JCB	8008	8018, 18Z, 19C-1	8029**, 8035, 8040, 1CX, MIDI CX, 2CX, 3CX-COMPACT	8045, 8052, 8060, 45Z-1, 48Z-1, 55Z-1, 57C-1, 67C-1	3CX, 4CX, 1400, 1500, 1700	JS70, 85Z-1, 86C-1, 90Z-1, 100C-1	3CX-SUPER 17, 4CX-SUPER 17	JS131, JS141, JS145, JZ145	JS160
 JOHN DEERE		17G	26G**, 30G, 35G	50G, 60G	310L, 310SL, 315SL, 410L	75G, 85G	710L	130G, 135G, 130P, 135P	160G, 160P
 KOBELCO		SK17SR-5E	SK25SR-6E**, SK30SR-6E, SK35SR-6E	SK45SRX-6E, SK55SRX-6E		SK75SR-3E, SK85CS-3E		SK115SR, SK130, SK135SR, SK140SR-5, ED160-5	SK160-5, SK170-10, ED190
 KOMATSU	PC09-1	PC18MR-3	PC27MR-3**, PC30MR-5, PC35MR-3/5	PC45MR-3/5, PC55MR-3/5	WB146-5, WB156-5	PC78US-10/11, PC88MR-10/11		PC120-8, PC130-11, PC138US-10/11	PC160-8, PC170-11/11
 Kubota	K008-3/5	KX018-4, KX41-3V, U17	KX71-3**, K91-3S2, KX030-4, KX033-4, U255**, U27-4, U35-4, B21, B26, L39, L45, L47, L48, M59**, R420S	KX040-4, XK057-4/5, KX121-3S, U45, U48-5, U55-4/5, R520, SR530, R630	M62	KX080-4, KX080-4S		R308, R914 Compact, R920 Compact	R317
 Link-Belt CONSTRUCTION EQUIPMENT						75 X3 SA, 75 MB, 80 X3 SA, 80 SB		130 X3/X4, 145 X3/X4 SA	160 X3/X4
 LIUGONG		9018F	904D, 9035EZTS	906D		908D			915E
 LONKING				CDM6065		CDM6085			CDM6150
 MUSTANG	80M	170Z	250Z**, 350Z	450Z, 550Z		800Z		1000M	
 NEW HOLLAND		E17C, E18B	E26C**, E27B**, E30B/C, E33C, E35B, E37C"	E55BX, E57C, E60C	B95C, B110C				
 SANY		SY16C	SY26U**, SY35U	SY50, SY60		SY75C, SY80U, SY95		SY135C, SY155U	
 TAKEUCHI	TB210R	TB216, TB216H	TB230, TB235-2, TB240	TB260		TB280FR, TB290		TB2150	
 VOLVO		EC20D	ECR25D**, EC27D**, EC35C/D, ECR38D, ECR40D	EC55C, ECR58D, EC60E, EW60E	BL60B, BL70B	ECR85D, ECR88D		EC140E, ECR145E, EWR150E	EC160E, EW160E, EW180E
 WACKER NEUSON	803	ET16, E217, ET20, 1404	EZ28**, EZ36, EZ38, 3503	EZ53, 6003, ET65, EW65		8003, ET90, EW100		ET145	
XCMG/ INTENSUS			XE35U	XE55U, XE35U-E	XE55U	XE75U		XE135B, XE150D/U	
 YANMAR	SV08-1A/B	Vi017-A	Vi025-6A**, Vi035-6A	Vi045-6A/B, Vi055-6A		Vi080-1A, SV100-2A			

*Note: All manufacturer's names, symbols, numbers & descriptions are used for reference only & does not mean that any part is the product of these manufacturers or approved by these manufacturers.

METRIC TON CLASS	20mT	25mT	27mT	35mT	45mT	60mT	80mT	100mT
BACKHOE CLASS								
CLASS	45	55	60	70	100	150	200	250
CWS CLASS	HE200	HE250	HE250	HE300	HE400	HE650	HE850	HE1200
RANGE	R6	R7		R8	R9			
								
	CX210D, CS235C SR, CX245D SR, CX220E	CX250D, CX260E	CX290D*, CX300E*, CX300D*, CX365E SR*	CX350C, CX350D	CX470C, CX490D	CX700B, CX750D	CX800B	
	318C, 319, 320E/F, 321D, 323F, 325F	324E, 325D	326F*, 328D*, 329E/F*, 330F*, 335F*	330D, 336E/F	349E/F, 352F	365C, 374D/F	385C, 390D/F	
DEVELON	DX200-7, DX210, DX210WE, DX225-6/7, DX235LCR-5/7	DX255-5/7	DX300-5/7*, DX350LCR-7*	DX340, DX350-5/7	DX420-5/7, DX450-3, DX490-5/7, DX530-5/7		DX800-7	DX1000-7
								
	ZX180-6, ZX190W-5, ZX190-7, ZX210-6/7, ZX225, ZX245US-6/7	ZX250-6	ZX290-5*, ZX300-6*, ZX345US-7*	ZX350-6, ZX380-6	ZX470-6, ZX490-6	ZX670-6, ZX690-6	ZX870-6, ZX890-6	EX1200-6/7
	R210W-9A, HW210, R220-9A, HX220L, HX235LCR	R260-9A, HX260L	R290*, R300-9A*, HX300L*	R320, R330-9A, R360, R380-9A, HX330L, HX380L	R450, R480-9A, R500, R520-9A, HX480L, HX520L			R1200-9A
IHI/KATO	HD823MR-7							
	JS190, JS220, 220X, JZ235	JS260	JS290*, JS300*	JS330, JS360, JS370	JS460			
	190GW, 200G, 210G, 210P, 245G, 245P	230GW, 250G, 250P	290G*, 300G*, 300P*, 345G*, 345P*	350G, 380G, 350P, 380P	470G	670G	870G	
	SK210-10, SK215, SK230SR-5, SK235SR-2, SK260SR-3, SK270SR-5	SK260-10	SK290*, SK295*, SK300-10*	SK350-10	SK485, SK500-10		SK850-9	
	PC210-10/11, HB215-2, PC228US-10, PC238US-11	PC240-10/11, PC308-8	PC290-10/11*	PC360-10/11, HB365-1/3, PC390-10/11	PC490-10/11	PC600-8, PC650-8/11	PC800-8, PC900-11	PC1250-8/11
								
	R904, R906, R914, R918, R920, R922, R926 Compact	R924, R926	R934, R936, R936 Compact	R934, R938, R945, R946	R945, R946, R950, R954, R956	R960, R964, R966	R970, R974, R976, R980	
	210 X3/X4, 235 X3 SA, 245 X4 SA	250 X3/X4	300 X3/X4*	350 X3/X4	470 X3, 490 X4	700 X2, 750 X4	800 X2	
	922E	925E	930E*	936E	950E			
	CDM6235			CDM6365	CDM6485			
								
								
	SY215C, SY225C	SY235C, SY265C		SY335C, SY365C	SY500H			
								
	EC210D, EW210D, EC220E, EW220E, EW230, ECR235E	EC250E	EC300E*, ECR305C*, ECR355E*	EC350E, EC360, EC380E	EC460, EC480E		EC700C, EC750E	
								
XCMG/ INTENSUS	XE200C, XE210U, XE215C	XE225CA, XE235C, XE250U, XE265C	XE300U	XE360C/U	XE470U/C/CK			
								

*Please contact sales for proper coupler. ** 2.5mT machine model - 3mT bucket may contact boom or boom cylinder guard. Contact Engineering for tip radius of bucket for specific machine.

QUICK HITCH BUCKETS

Compatible with TAG Couplers



Quick Hitch Buckets are like other buckets used for excavation, digging and land clearing, with the added feature of a faster way to exchange different size buckets; this allows similar sized machines to share the same buckets. Quick Hitch buckets are compatible with TAG couplers.

PART #	DESCRIPTION
02HQ012-E00-X156S3-P-027	1 TO 2 METRIC TON MACHINE (12" QUICK HITCH BUCKET)
02HQ018-E00-X156S4-P-027	1 TO 2 METRIC TON MACHINE (18" QUICK HITCH BUCKET)
03HQ012-E00-X156S3-P-027	2.5 TO 3.5 METRIC TON MACHINE (12" QUICK HITCH BUCKET)
03HQ016-E00-X156S4-P-027	2.5 TO 3.5 METRIC TON MACHINE (16" QUICK HITCH BUCKET)
03HQ018-E00-X156S4-P-027	2.5 TO 3.5 METRIC TON MACHINE (18" QUICK HITCH BUCKET)
03HQ024-E00-X156S5-P-027	2.5 TO 3.5 METRIC TON MACHINE (24" QUICK HITCH BUCKET)
05HQ012-E00-X156S3-P-027	5 TO 6 METRIC TON MACHINE (12" QUICK HITCH BUCKET)
05HQ018-E00-X156S4-P-027	5 TO 6 METRIC TON MACHINE (18" QUICK HITCH BUCKET)
05HQ024-E00-X156S5-P-027	5 TO 6 METRIC TON MACHINE (24" QUICK HITCH BUCKET)
05HQ030-E00-X156S5-P-027	5 TO 6 METRIC TON MACHINE (30" QUICK HITCH BUCKET)
08HQ012-E00-X156S3-P-030	BACKHOE + 7 TO 8 METRIC TON MACHINE (12" QUICK HITCH BUCKET)
08HQ018-E00-X156S4-P-030	BACKHOE + 7 TO 8 METRIC TON MACHINE (18" QUICK HITCH BUCKET)
08HQ024-E00-X156S5-P-030	BACKHOE + 7 TO 8 METRIC TON MACHINE (24" QUICK HITCH BUCKET)
08HQ036-E00-X156S6-P-030	BACKHOE + 7 TO 8 METRIC TON MACHINE (36" QUICK HITCH BUCKET)

QUICK HITCH COUPLERS

The **Quick Hitch™ Coupler** provides a simple and reliable means of adding versatility to your excavator.

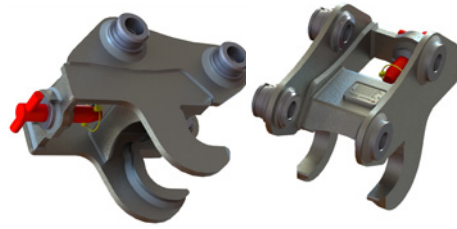

PART #	DESCRIPTION
027 QH	027 QUICK HITCH COUPLER
030 QH	030 QUICK HITCH COUPLER

*Machine specific item, call for actual part number

MAIN PIN THUMBS

PART #	DESCRIPTION
005HT	2.5 TO 3.5 METRIC TON MACHINE (MAIN PIN HYDRAULIC THUMB)
025HT	5 TO 6 METRIC TON MACHINE (MAIN PIN HYDRAULIC THUMB)
050HT	BACKHOE + 7 TO 8 METRIC TON MACHINE (MAIN PIN HYDRAULIC THUMB)

*Machine specific item, call for actual part number

MX BRUSH CUTTER



MX Series mini excavator brush cutters are an extension of Paladin’s successful GroundShark series for skid-steers. Compatible with mini excavators in the 3-8 ton machine class, the MX Series facilitates a variety of applications, including over-fence brush management, embankment and ditch management, and rail right-of-way management. A solid formed T-1 steel deck and reversible AR400 cutting blades powers efficient processing of brush and trees up to 6” in diameter. Equipped with Paladin’s bolt-on mounting system, it offers seamless configuration to a variety of coupling systems. When coupling requirements change, units can be quickly and easily reconfigured without welding or grinding, even in the field.

PART #	DESCRIPTION
BC40MX10	40” MIN-EX BRUSH CUTTER, 3MT, 13-19 GPM, ADAPTER PATTERN A
BC40MX20	40” MIN-EX BRUSH CUTTER, 3MT, 19-26 GPM, ADAPTER PATTERN A
BC50MX10	50” MIN-EX BRUSH CUTTER, 5MT, 17-22 GPM, ADAPTER PATTERN B OR C
BC50MX20	50” MIN-EX BRUSH CUTTER, 5MT, 22-34 GPM, ADAPTER PATTERN B OR C
BC60MX10	60” MIN-EX BRUSH CUTTER, 8MT, 20-28 GPM, ADAPTER PATTERN B OR C
BC60MX20	60” MIN-EX BRUSH CUTTER, 8MT, 28-35 GPM, ADAPTER PATTERN B OR C

OPERATOR PROTECTION



Patent-pending Tilt Latch™ engages when the cutter is curled up, keeping the blade shield locked down

AGGRESSIVE CUTS



Swings open when engaged with brush and trees, exposing the blades for deep, aggressive cuts

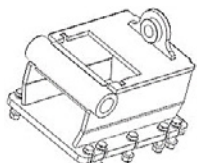

CP ADAPTERS:

CP Adapters leverage legacy Quick Hitch designs and are commonly used in Rental applications. Paladin CP adapters are designed to work with Paladin manufactured couplers and are available from 1/8 yard size (CP027), 1/4 yard (CP030) and 1/2 yard (CP034), and fit the full family of Strikeforce products.

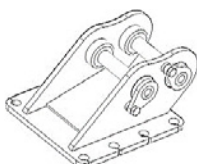

DEDICATED/CUSTOM ADAPTERS:

These adapters are designed to match the OEM machine interface exactly and include OEM matching Pin groups. As a "custom" offer they have a longer lead-time than the CORE Adapter Systems. Paladin provides Estimate responses for special requests but will include a CORE option recommendation in addition to the Custom response.

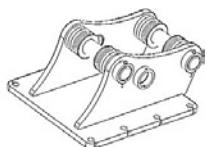

CORE ADAPTER:

These brackets are used for Pin-Grabber type couplers and Pin-Drive applications where exact pin center duplication is not required. These will not be suitable for Pin-Loc type applications or where pin center match is required to ensure a secure/safe fit-up to the carrier. Lead-time for the CORE will be less due to the standardized inventory possibilities. CORE brackets come complete with Pins and the width adjustment spacers.

IMPORTANT: understanding the type of installation is critical in determining whether a CORE Adapter is suitable. Please have the coupler information available, specifically the importance of Pin-Center to center dimensions, when consulting with sales team members.



QUICK HITCH ADAPTER:

These Adapters are designed to match a machine OEM's proprietary (non-pin) mounting interface. These systems are used to reduce bucket offset in quick attach systems (as opposed to Pin Grabber type), thereby maximizing breakout force with the bucket. These systems can be used reliably with hydraulic attachments and Paladin provides a full offering of these Adapters for the StrikeForce product line. The defining feature of these types of systems is the use of geometry (shape) and not pins to attach the tool to the machine.

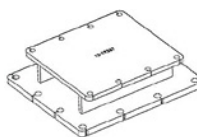

PATTERN ADAPTER:

These items convert one pattern family to a larger or smaller family to allow use of existing Mounting Adapters wherever possible. This reduces end customer cost and increases the velocity from the factory by leveraging existing designs and on-hand stock. A "Hardware Kit" will be required for the Adapter side.

HD BUCKETS & DITCH BUCKETS



Heavy Duty Buckets: Generally accepted as an industrial quality tool, these buckets are stronger and more wear-resistant than general purpose buckets.

Ditch Buckets: Perfect for ditch-cleaning applications. Designed with an abrasion-resistant “double bottom”, which allows for longer bucket life.

PART #	DESCRIPTION
12mT - HD BUCKETS - NO SIDE CUTTERS - NO DEAD PINS	
12HE018-E33D-CJ25S3-J-5130	18" PIN ON BUCKET, VLV EC140/ECR145
12HE018-E33D-CJ25S5-J-2131	18" BUCKET KOBELCO 135SR/SRLC
12HE018-E33D-CJ25S5-J-7120	18" BUCKET JOHN DEERE 120C/CLC/C
12HE018-E33D-CJ25S5-J-9011	18" BUCKET CASE CX130/CX135
12HE018-E33D-CJ30S3-J-9010	18" BUCKET LINKBELT 130LX/135MSR
12HE024-E33D-CJ25S4-J-5130	24" PIN ON BUCKET, VLV EC140/ECR145
12HE024-E33D-CJ25S5-J-2131	24" BUCKET KOBELCO 135SR/SRLC
12HE024-E33D-CJ25S5-J-7120	24" BUCKET JOHN DEERE 120C/CLC/C
12HE036-E33D-CJ25S5-J-5130	36" PIN ON BUCKET, VLV EC140/ECR145
12HE036-E33D-CJ25S5-J-2131	36" BUCKET KOBELCO 135SR/SRLC
12HE036-E33D-CJ25S5-J-7120	36" BUCKET JOHN DEERE 120C/CLC/C
12HE036-E33D-CJ25S5-J-9010	36" BUCKET JCB JS130
12HE036-E33D-CJ25S5-J-9011	36" BUCKET CASE CX130/CX135
12HE042-E33D-CJ25S5-J-2131	42" BUCKET KOBELCO 135SR/SRLC
12HE042-E33D-CJ25S5-J-7120	42" BUCKET JOHN DEERE 120C/CLC/C
12HE042-E33D-CJ25S5-J-9011	42" BUCKET CASE CX130/CX135
12HE048-E33D-CJ25S6-J-5130	48" PIN ON PIN ON BUCKET, VLV EC140/ECR145
12HE048-E33D-CJ25S6-J-2131	48" PIN ON BUCKET KOBELCO 135SR/SRLC
12HE048-E33D-CJ25S6-J-7120	48" PIN ON BUCKET JOHN DEERE 120C/CLC/C
12HE048-E33D-CJ25S6-J-9010	48" PIN ON BUCKET JCB JS130
12HE048-E33D-CJ25S6-J-9011	48" PIN ON BUCKET CASE CX130/CX135
15mT - HD BUCKETS - NO SIDE CUTTERS - NO DEAD PINS	
15HE024-E33D-CJ30S5-J-9020	24" HD EXC BKT FOR CASE CX160
15HE036-E33D-CJ30S5-J-2151	36" BUCKET KOBELCO SK150/SK160/LC
15HE036-E33D-CJ30S5-J-7150	36" BUCKET JOHN DEERE 160C/160CLC/LC
15HE036-E33D-CJ30S5-J-9020	36" BUCKET CASE CX160
15HE042-E33D-CJ30S5-J-2151	42" BUCKET KOBELCO SK150/SK160/LC
15HE042-E33D-CJ30S5-J-7150	42" BUCKET JOHN DEERE 160C/160CLC/LC
15HE042-E33D-CJ30S5-J-9020	42" BUCKET CASE CX160

20mT - HD BUCKETS - NO SIDE CUTTERS - NO DEAD PINS

20HE024-E33D-CJ35S3-J-7201	24" PIN ON BUCKET, VLV EC200/EC220/ECR235
20HE024-E33D-CJ35S5-J-7201	24" BUCKET JOHN DEERE 200C/CLC/LC
20HE024-E33D-CJ35S5-J-9030	24" BUCKET CASE CX210/CX225 & JCB 220/JS220
20HE036-E33D-CJ35S5-J-7201	36" PIN ON BUCKET, VLV EC200/EC220/ECR235
20HE036-E33D-CJ35S5-J-2201	36" BUCKET KOBELCO SK210
20HE036-E33D-CJ35S5-J-7201	36" BUCKET JOHN DEERE 200C/CLC/LC
20HE036-E33D-CJ35S5-J-9030	36" BUCKET CASE CX210/CX225 & JCB 220/JS220
20HE042-E33D-CJ35S5-J-7201	42" PIN ON BUCKET, VLV EC200/EC220/ECR235
20HE042-E33D-CJ35S5-J-2201	42" BUCKET KOBELCO SK210
20HE042-E33D-CJ35S5-J-7201	42" BUCKET JOHN DEERE 200C/CLC/LC
20HE042-E33D-CJ35S5-J-9030	42" BUCKET CASE CX210/CX225 & JCB 220/JS220
20HE048-E33D-CJ35S6-J-7201	48" PIN ON BUCKET, VLV EC200/EC220/ECR235
20HE048-E33D-CJ35S6-J-2201	48" BUCKET KOBELCO SK210
20HE048-E33D-CJ35S6-J-7201	48" BUCKET JOHN DEERE 200C/CLC/LC
20HE048-E33D-CJ35S6-J-9030	48" BUCKET CASE CX210/CX225 & JCB 220/JS220

12mT & 20mT DITCH CLEAN BUCKETS - W/BOLT ON EDGE - INCLUDES DEAD PINS





7120050D060000N000YNCNP	60" DITCH CLEAN BUCKET, W/BOE, W/DEAD PINS JOHN DEERE 120C/CLC/C
9011050D060000N000YNCNP	60" DITCH CLEAN BUCKET, W/BOE, W/DEAD PINS CASE CX130/CX135
2131050D060000N000YNCNP	60" DITCH CLEAN BUCKET, W/BOE, W/DEAD PINS KOBELCO 135SR/SRLC
2201100D060000N000YNCNP	60" DITCH CLEAN BUCKET, W/BOE, W/DEAD PINS KOBELCO SK210
7201100D060000N000YNCNP	60" DITCH CLEAN BUCKET, W/BOE, W/DEAD PINS JOHN DEERE 200C/CLC/LC
9030100D060000N000YNCNP	60" DITCH CLEAN BUCKET, W/BOE, W/DEAD PINS CX210/CX225 & JCB 220/JS220

WHEEL LOADER / BACKHOE LOADER MACHINE CLASSIFICATION

The corresponding OEM with the machine size will provide you with the proper class attachment for your equipment.

CLASS (JRB Interchange)					
OEM	100 (Machine Dependent)	200 (416)	300 (416)	500 (416)	600 (418)
CWS Class	WL075/100	WL200	WL250	WL300	WL400
	580N, 580SN 580SNWT, 590N 590SN	521G	621G	721G	821G 921G
	415F2, 416F2 420F2, 430F2	450F, 906M, 907M, 908M, 910M, 926M, IT14G2"	930M	938M	950M 962M
			DL200-5 DL200TC-5	DL250-5 DL250TC-5 DL280-5	DL300-5 DL350-5
		ZW120-5B ZW140-5B ZW140PL-5B	ZW150-5B ZW150PL-5B	ZW180-5B ZW180PL-5B	ZW220-5B ZW250PL-5B
			HL940 HL940TM	HL955	HL960 HL965
	3CX 17 4CX 17	409, 411 417	427ZX 427HT	437ZX 437HT	457ZX 457HT
	204L, 304L, 310L, 310SL, 315SL 410L, 244K	710K, 324K 344L, 444K	524L 544L	624L	644K 724K
	45ZV-2	60Z7	"62Z7 67Z7"	70Z7	"80Z7 85Z7"
		WA150-6	WA200-8	WA270PZ-8 WA320PZ-8	WA380-8 WA430-8
		L526	L538	L546	L550 L556
	CLG816G	CLG835III Z CLG835III TC		CLG842III Z CLG842III TC	CLG856III Z
	W50C W80C				
				SW3025K	SW405K
			LG938L	LG948L	LG958 LG959L
	L30G L35G	L50H	L60H L70H	L90H	L110H L120H

*Note: All manufacturer's names, symbols, numbers & descriptions are used for reference only & does not mean that any part is the product of these manufacturers or approved by these manufacturers.

CLASS (JRB Interchange)						
OEM	700 (420)	800 (420)	900 (422)	1000	1100	1200
CWS Class	WL500/550	WL600	WL700	WL800	WL900	WL1200
	1021G 1121G	1221G				
	966M 972M	980M 982M	986K 988K	990K	992K 993K	994K
	DL420-5 DL450-5	DL550-5				
	ZW310-5B ZW330PL-5B	ZW370-5B ZW370PL-5BXRT	ZW550-5B			
	HL970 HL975	HL980				
						
	744K-III 824K-III	844K-III	944K			
	90Z7 92Z7	95Z7	115Z7	135ZV-2		
	WA470-8 WA480-8	WA500-8	WA600-8		WA800-3 WA900-3	WA1200-6
	L566 L580	L586				
	CLG877III CLG888III					
						
						
						
	L150H L180H	L220H L260	L350H			

* Machines marked with * please contact sales for proper coupler. Contact JRB's Customer Service for price and availability on non-current machine attachments.

GENERAL PURPOSE BUCKET



- Material weight 1800 to 2500 pounds
- Sloped-bottom design allows for maximum fill capabilities and material retention
- Slope bottom increases dump angle by 5° for more efficient dumping capabilities
- Minimum 50 yield steel construction
- Widths and cutting edge hole patterns drilled to OEM standard wear parts specifications

PART #	DESCRIPTION
90D1167	3.0 CYD GP BUCKET W/ EDGE 105.7" WIDE, JRB 416 COUPLER
94D0001-0913	3.0 CYD GP BUCKET W/ EDGE 100.4" WIDE, JRB 416 COUPLER
90D2730	3.5 CYD GP BUCKET W/ EDGE 107.88" WIDE, JRB 416 COUPLER
94D0002-0913	3.5 CYD GP BUCKET W/ EDGE 100.4" WIDE, JRB 416 COUPLER
90D3718	4.0 CYD GP BUCKET W/ EDGE 119.68" WIDE, JRB 418 COUPLER
90D3580	4.25 CYD GP BUCKET W/ EDGE 119.68" WIDE, JRB 418 COUPLER

SNOW PUSH



The **JRB Snow Pushers** allow for quick and easy installation by pushing with your loader bucket.

PART #	DESCRIPTION
23396-0057	3X3 96" SNOW PUSH BUCKET LIP MOUNT
23320-0057	3X3 120" SNOW PUSH BUCKET LIP MOUNT
23344-0057	3X3 144" SNOW PUSH BUCKET LIP MOUNT
23368-0057	3X3 168" SNOW PUSH BUCKET LIP MOUNT
23396-0913	3X3 96" SNOW PUSH JRB 416 COUPLER
23320-0913	3X3 120" SNOW PUSH JRB 416 COUPLER
23344-0913	3X3 144" SNOW PUSH JRB 416 COUPLER

CONSTRUCTION FORKS



JRB®'s Construction Forks allow you to safely navigate job sites carrying construction materials like pallets, pipes and related equipment with our rugged, newly designed CUFs.

PART #	DESCRIPTION
90K2001-0913	60" X 60" CONSTRUCTION FORKS JRB 416 COUPLER CLASS 200/300/500
90K2006-0913	96" X 60" CONSTRUCTION FORKS JRB 416 COUPLER CLASS 200/300/500
90K2007-0913	96" X 72" CONSTRUCTION FORKS JRB 416 COUPLER CLASS 200/300/500
90K2009-0913	96" X 96" CONSTRUCTION FORKS JRB 416 COUPLER CLASS 200/300/500
90K0005	106" X 60" CONSTRUCTION FORKS JRB 418 COUPLER CLASS 600
90K0105	106" X 72" CONSTRUCTION FORKS JRB 418 COUPLER CLASS 600
90K0751	106" X 96" CONSTRUCTION FORKS JRB 418 COUPLER CLASS 600

LOADER RAKE



JRB's Loader Rakes are ideal for land clearing, raking brush, and piling trees and limbs

PART #	DESCRIPTION
90Z0040	LOADER ROOT RAKE LESS CLAMP, 105" WIDE, JRB 416 COUPLER CLASS 200/300/500
90Z0046	LOADER ROOT RAKE W/ CLAMP, 105" WIDE, JRB 416 COUPLER CLASS 200/300/500
90Z0165	STACKING RAKE W/GRAPPLE CLAMP, 105" WIDE, JRB 416 COUPLER CLASS 200/300/500

**SELECTION.
INNOVATION.
PERFORMANCE.**

