



COMPACT ATTACHMENTS



YOUR "ONE-STOP SHOP"

FOR HYDRAULIC TOOLS AND ATTACHMENTS



Paladin is the trusted name and global leader for quality, productive, and powerful mini, compact, and heavy equipment attachments. Our hydraulic tools and attachments are made to work as hard as the people that use them.

FEATURED PRODUCT

FD60 FORESTRY DISK MULCHER



Maximize Productivity and Up-Time

- Wide-angle intake promotes mulching and helps avoid jams
- Ultra-efficient drive system starts up fast and delivers tremendous power to the head

Minimize Service Time and Costs

- Zero-maintenance bearing housing never needs to be greased
- Reinforced debris shovel keeps teeth out of the dirt and places material perfectly for optimal processing
- Interchangeable QUADCO teeth simplifies service and allows for tooth rotation to combat uneven wear patterns

Flexible Across Applications

- Control debris projection with a two-position, adjustable deflector
- Removable debris shovel allows teeth to work below grade and provides easier processing of light brush
- Dual-function push bar smoothly pulls trees in on the right side, grabs to manipulate trees on the left side

Reap the Benefits of Superior Power

Paladin MulchPower™ Technology provides live, dynamic power and loading feedback to the operator through a unique pressure monitoring gauge. With MulchPower™ operators can see when the tool is fully charged and also when it is nearing a state of being overloaded, so that operating technique can be adjusted to maximize performance.



- **RUN AT PEAK POWER:** Greater starting power improves cutting efficiency and tool life, increasing overall job productivity and decreasing total operating costs.
- **AVOID JAMMING:** Greater starting power dramatically reduces the likelihood of jamming and stalling.
- **WORK WITH CONFIDENCE:** Conditions change from job to job. MulchPower™ lets you be more aggressive when the job will allow it, letting you maximize your production.

MANUFACTURING FACILITIES

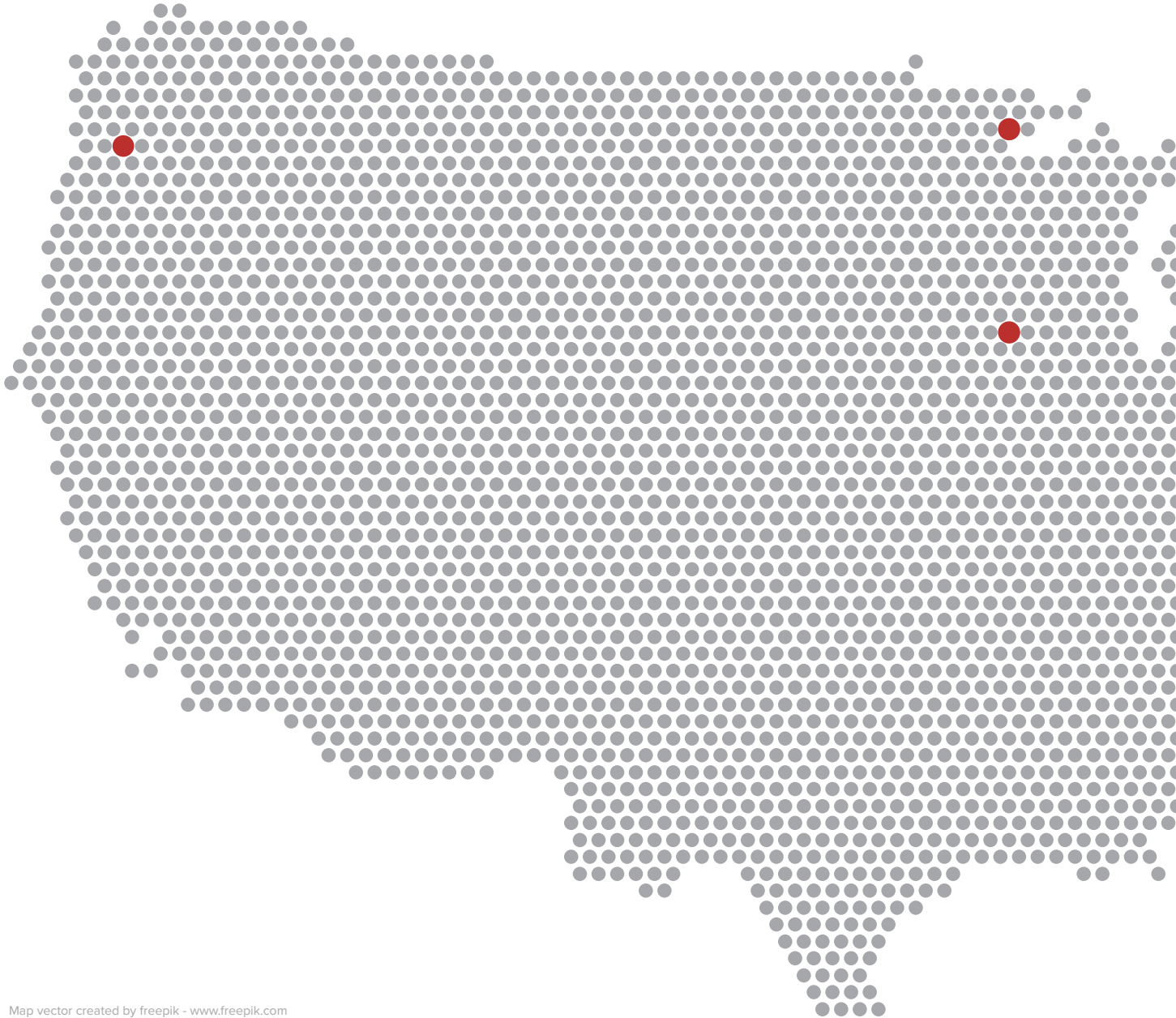

Map vector created by freepik - www.freepik.com

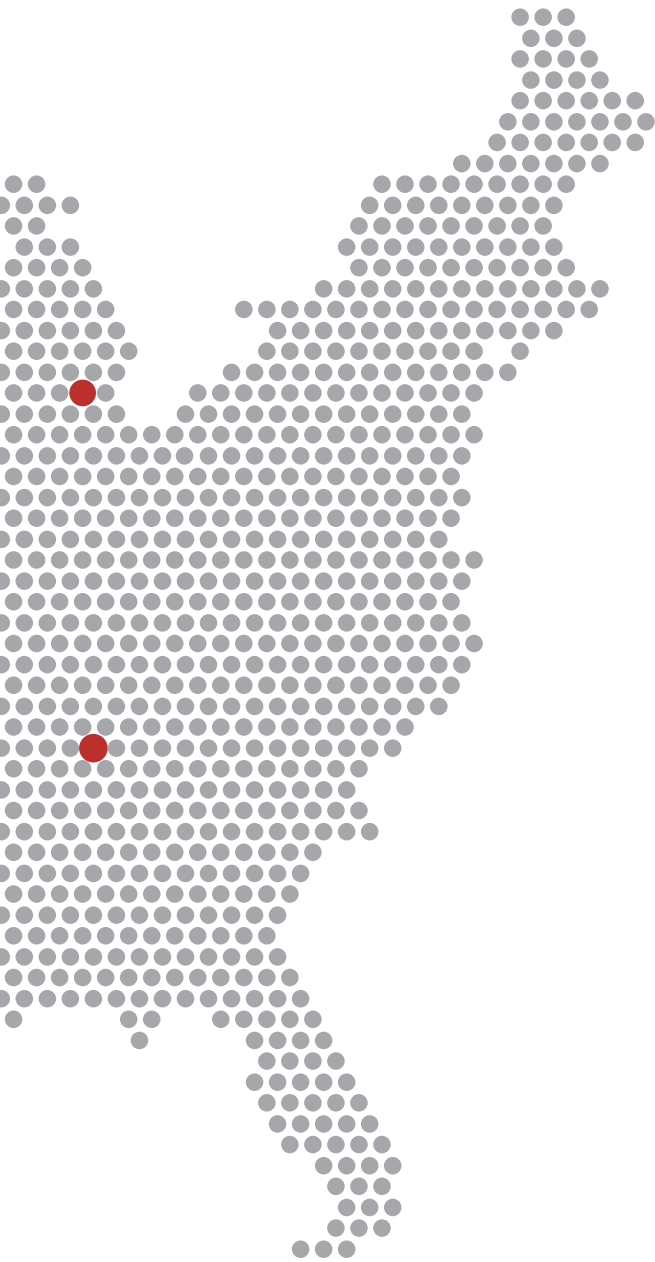

Dexter Facility

2800 Zeeb Road
Dexter, MI, 48130

Delhi Facility

503 Gay Street
Delhi, IA, 52223

Ooltewah Facility

8822 Apison Pike
Ooltewah, TN, 37363

Surrey Facility

19490 92nd Avenue
Surrey, B.C. Canada V4N 4G7

Milwaukie Facility

3810 SE Naef Road
Milwaukie, OR 97267

Two Harbors Facility

1538 Hwy 2
Two Harbors, MN 55616

AVAILABLE OPTIONS



HEAVY-DUTY BUMPER



GRILLE GUARD



SWEEPS



TOP GUARD W/ LIGHT GUARDS



HYDRAULIC CONNECTOR GUARD



INTAKE SCREENS



FRONT LIGHT GUARDS



SIDE WINDOW GUARDS

FEATURES AND BENEFITS

- Heavy-duty design protects machine from harsh forestry, scrap, and demolition environments while maintaining visibility and functionality
- Rear screen utilizes quick-release latches, allowing for quick egress in emergency situations
- Grille guard provides protection while maintaining easy access to engine compartment
- Modular kit design allows customization of guarding level
- Installation may require minimal welding to machine frame

MACHINE COMPATIBILITY

Available for 90+ HP T4F Machines:

- | | |
|-----------|--------|
| • DL55 | • C234 |
| • SR270B | • C238 |
| • SV300 | • C334 |
| • SV340/B | • C345 |
| • TR340/B | • C362 |
| • TV380 | • C334 |
| • TV450/B | |
| • TV620B | |

AVAILABLE OPTIONS



HEAVY-DUTY TOP GUARD



FRONT LIGHT GUARDS



REAR LIGHT GUARDS



HYDRAULIC CONNECTOR GUARD



REAR GUARD



DEBRIS SHIELD

FEATURES AND BENEFITS

- Heavy-duty design protects machine from harsh forestry, scrap, and demolition environments while maintaining visibility and functionality
- Rear screen provides protection without compromising airflow
- Grille guard provides protection while maintaining easy access to engine compartment
- Bolt-on design: installation requires no modification

MACHINE COMPATIBILITY

Available for Kubota SVL Machines:

- SVL75-2
- SVL90-2
- SVL95-2/2S
- SVL97-2
- Does not fit SSV machines

Warranty Period and Covered Products

WARRANTY PERIOD	COVERED PRODUCTS		
	BRAND	PRODUCT	
FIVE YEARS	PENGO	CS SERIES - GEARBOX ONLY. NOTE: Requires annual maintenance performed	
THREE YEARS	PENGO	CS SERIES - HYDRAULIC MOTOR NOTE: Requires annual maintenance performed	
TWO YEARS	STRIKE FORCE	HYDRAULIC TOOLS (BREAKERS, PLATE COMPACTORS & WHEEL COMPACTORS)	
	PENGO	GEARBOX (OR 500 OPERATIONAL HOURS WHICHEVER COMES FIRST). NOTE: PENGO Drives are not warranted for DTH applications.	
ONE YEAR	JRB	WHEEL LOADER COUPLERS (JRB E SERIES, 416, 418, 420, 422 & ISO SERIES)	
	BRADCO:	BACKHOES, TRENCHERS, DOZER BLADES, PALLET FORKS, GRAPPLE BUCKETS, 4-IN-1 BUCKETS, DIRT BUCKETS, TREE SPADES, POST DRIVERS, STUMP GRINDERS, MULCHERS, COLD PLANERS, BRUSH CUTTERS, FLAIL MOWERS, TREE SHEARS, JAWZ GRABBING TOOL, QUICK PIK MULTI-PURPOSE GRAPPLE, VIBRATORY ROLLER, VIBRATORY PLOW, ROCK SAWS, SILAGE DEFACER, MINI SKID STEER PRODUCTS	
	CP	ALL PRODUCTS	
	CUSTOM WORKS	ALL PRODUCTS (OTHER THAN JRB CUSTOM WORKS)	
	CWS	ALL PRODUCTS	
	FFC	ALL PRODUCTS	
	HARLEY	ALL PRODUCTS	
	MCMILLEN	ALL PRODUCTS	
	SWEEPSTER	ALL PRODUCTS	
	JRB	ALL PRODUCTS (EXCEPT CUSTOM WORKS & HITCH LATCH KITS)	
	PENGO	ALL PRODUCTS	
	PENGO	CS SERIES - ENTIRE DRIVE UNIT	
	90 DAYS	JRB	CUSTOM WORKS & HITCH LATCH KITS
		BRADCO	REAR STABILIZER KITS
JRB		HITCH LATCH KITS	
PALADIN		NEW REPLACEMENT PARTS	

NOTE: JRB couplers and JRB adapters are manufactured to interface only with JRB attachments, OEM attachments and JRB female adaptors (ribs)- and the use of a JRB coupler or a JRB adapter with any other attachments (including non-standard attachments, OEM attachments or JRB female adaptors (ribs)) may not be covered and has the potential to void warranty.

JRB hydraulic kits and couplers are designed and tested to be used together. The use of a non-JRB coupler with a JRB kit or the use of a non-JRB kit with a JRB coupler may not be covered and has the potential to void warranty.



For comprehensive warranty information, please visit www.paladinattachments.com/support/warranty-information, or scan the QR code.

TABLE OF CONTENTS

<p>ADAPTERS</p>  <p>18</p>	<p>CS AUGER DRIVES</p> <p>NEW</p>  <p>22</p>	<p>CS AUGER MOUNTS</p>  <p>25</p>	<p>PENGO DT-5 AUGER DRIVES</p>  <p>26</p>	<p>PENGO DT-15 AUGER DRIVES</p>  <p>27</p>
<p>PENGO DV-20 AUGER DRIVES</p>  <p>28</p>	<p>PENGO DV-30 AUGER DRIVES</p>  <p>29</p>	<p>PENGO DV-40 AUGER DRIVES</p>  <p>30</p>	<p>PENGO AUGER MOUNTS</p>  <p>32</p>	<p>LANDSCAPE AGGRESSOR AUGER BITS</p>  <p>37</p>
<p>AGGRESSOR AUGER BITS</p>  <p>38</p>	<p>AGGRESSOR TREE AUGER BITS</p>  <p>39</p>	<p>TRIMAX AUGER BITS</p>  <p>40</p>	<p>SEVERE ROCK RIPPER AUGER BITS</p>  <p>42</p>	<p>AUGER TEETH</p>  <p>43</p>
<p>PILOT BITS</p>  <p>44</p>	<p>BORH AND EXTENSIONS</p>  <p>45</p>	<p>HUBS AND INSTALL TOOLS</p>  <p>46</p>	<p>QUICK CHANGE EXCAVATOR AUGERS</p>  <p>47</p>	<p>EXCAVATOR AUGERS</p>  <p>50</p>
<p>BALE/HAY GRAPPLE BUCKET</p>  <p>56</p>	<p>BALE/HAY GRAPPLE BUCKET HEAVY-DUTY</p>  <p>57</p>	<p>BALE CARRIAGE - DUAL LARGE SQUARE</p>  <p>58</p>	<p>BALE HUGGER</p>  <p>59</p>	<p>BALE SPEARS</p>  <p>60</p>
<p>BOOMS - LOADER</p>  <p>62</p>	<p>BOOMS - TREE</p>  <p>63</p>	<p>BOOMS - TRUSS</p>  <p>63</p>	<p>GROUND SHARK - STANDARD DUTY</p>  <p>70</p>	<p>GROUND SHARK - HEAVY DUTY</p>  <p>72</p>
<p>GROUND SHARK - HIGH PERFORMANCE</p> <p>NEW</p>  <p>74</p>	<p>GROUND SHARK - EXTREME DUTY</p>  <p>76</p>	<p>SSL GUARDING PACKAGES</p>  <p>78</p>	<p>MX SERIES BRUSH CUTTER</p>  <p>80</p>	

Note: All manufacturer's names, symbols, numbers and descriptions are used for reference purposes only and does not mean that any part is the product of these manufacturers or approved by these manufacturers.

TABLE OF CONTENTS

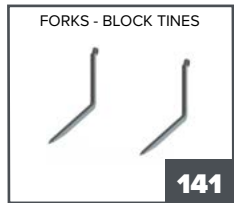
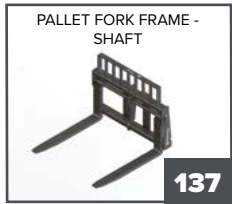

Note: All manufacturer's names, symbols, numbers and descriptions are used for reference purposes only and does not mean that any part is the product of these manufacturers or approved by these manufacturers.

TABLE OF CONTENTS

<p>ITA TINES</p>  <p>144</p>	<p>SHARKBITE GRAPPLE</p>  <p>146</p>	<p>HEAVY-DUTY BRUSH GRAPPLES NEW</p>  <p>147</p>	<p>STANDARD-DUTY BRUSH GRAPPLES</p>  <p>148</p>	<p>HEAVY-DUTY SCRAP GRAPPLES</p>  <p>150</p>
<p>HEAVY-DUTY SCRAP GRAPPLES - MODEL 120</p>  <p>151</p>	<p>HEAVY-DUTY SCRAP GRAPPLES - MODEL 130</p>  <p>154</p>	<p>STANDARD-DUTY SCRAP GRAPPLES</p>  <p>155</p>	<p>LOG GRAPPLE</p>  <p>156</p>	<p>SKELETON FORK & GRAB</p>  <p>157</p>
<p>TRASH CLAMP</p>  <p>157</p>	<p>LAND SCULPTOR</p>  <p>158</p>	<p>FORK MOUNTED CRANE HOOK</p>  <p>159</p>	<p>LIFTING HOOK</p>  <p>159</p>	<p>AUXILIARY HYDRAULIC CONVERSION KIT</p>  <p>160</p>
<p>MANURE PUSH</p>  <p>161</p>	<p>MINI ADAPTERS</p>  <p>164</p>	<p>MINI AUGER DRIVES NEW</p>  <p>165</p>	<p>MINI ANGLE BROOM</p>  <p>167</p>	<p>MINI DIRT BUCKETS NEW</p>  <p>168</p>
<p>MINI LIGHT MATERIAL BUCKETS NEW</p>  <p>169</p>	<p>MINI ROCK BUCKETS</p>  <p>170</p>	<p>MINI 4-IN-1 BUCKETS</p>  <p>170</p>	<p>MINI DOZER BLADE</p>  <p>171</p>	<p>MINI BRUSH GRAPPLES NEW</p>  <p>172</p>
<p>MINI ROOT GRAPPLES NEW</p>  <p>172</p>	<p>MINI SCRAP GRAPPLES NEW</p>  <p>173</p>	<p>MINI LEVELER</p>  <p>174</p>	<p>MINI POWER SHOVEL</p>  <p>174</p>	<p>MINI PALLET FORKS</p>  <p>175</p>
<p>MINI POWER BOX RAKE</p>  <p>175</p>	<p>MINI SKID/SWING HOES</p>  <p>176</p>	<p>MINI SNOW BLADE</p>  <p>176</p>	<p>MINI SNOW BLOWER</p>  <p>177</p>	<p>MINI STUMP GRINDER</p>  <p>178</p>

Note: All manufacturer's names, symbols, numbers and descriptions are used for reference purposes only and does not mean that any part is the product of these manufacturers or approved by these manufacturers.

TABLE OF CONTENTS

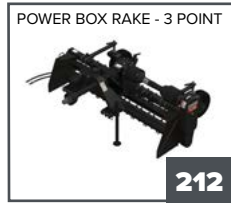
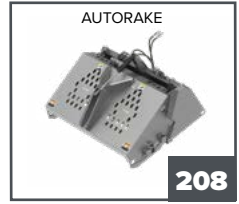

Note: All manufacturer's names, symbols, numbers and descriptions are used for reference purposes only and does not mean that any part is the product of these manufacturers or approved by these manufacturers.

TABLE OF CONTENTS

<p>CTH ANGLE SWEEPER</p>  <p>258</p>	<p>CTM ANGLE SWEEPER</p>  <p>260</p>	<p>MRHL ANGLE SWEEPER</p>  <p>261</p>	<p>MRH ANGLE SWEEPER</p>  <p>264</p>	<p>RMRM ANGLE SWEEPER</p>  <p>266</p>
<p>RHFA ANGLE SWEEPER</p>  <p>267</p>	<p>RLH ANGLE SWEEPER</p>  <p>269</p>	<p>AH/CH ANGLE SWEEPER</p>  <p>272</p>	<p>QTCL ANGLE SWEEPER</p>  <p>275</p>	<p>SB HOPPER COLLECTOR SWEEPER</p>  <p>278</p>
<p>SB HOPPER COLLECTOR SWEEPER - HEAVY-DUTY</p>  <p>279</p>	<p>SB HOPPER COLD PLANER SPECIAL</p>  <p>281</p>	<p>VRS COLLECTOR SWEEPER</p>  <p>282</p>	<p>VS COLLECTOR SWEEPER</p>  <p>283</p>	<p>CS COLLECTOR SWEEPER</p>  <p>285</p>
<p>VCS COLLECTOR SWEEPER</p>  <p>287</p>	<p>REPLACEMENT BRUSHES</p>  <p>290</p>	<p>TILLERS</p>  <p>295</p>	<p>TREE FORKS</p>  <p>296</p>	<p>TREE SCOOP</p>  <p>296</p>
<p>TREE SPADE</p>  <p>297</p>	<p>TRENCHER MODEL 330</p>  <p>301</p>	<p>TRENCHER MODEL 612</p>  <p>303</p>	<p>TRENCHER MODEL 625</p>  <p>305</p>	<p>TRENCHER MODEL 640</p>  <p>309</p>
<p>VIBRATORY PLOW</p>  <p>312</p>	<p>VIBRATORY ROLLER</p>  <p>313</p>			

Note: All manufacturer's names, symbols, numbers and descriptions are used for reference purposes only and does not mean that any part is the product of these manufacturers or approved by these manufacturers.

ICON KEY



Ag Loader



Excavator



Telehandler



Backhoe



Mini Excavator



Tractor



Commercial Turf Mower



Wheel Loader



Truck



Compact Tractor



Compact Tool Carrier



Walk Behind



Skid-Steer



Compact Wheel Loader

Note: All manufacturer's names, symbols, numbers and descriptions are used for reference purposes only and does not mean that any part is the product of these manufacturers or approved by these manufacturers.

HOW TO ORDER AN ATTACHMENT

Since many of our attachments are customized to your needs, when you place your order you will need to choose your attachment, the mounting, and any options you would like. As you look through the products, notice the red headings in the charts - they will alert you to the choices you need to make.

Choose your attachment - be sure to check loader capacity before ordering

BUCKET		
CHECK LOADER CAPACITY BEFORE ORDERING		
	ORDER CODE	SHIP WEIGHT (LBS)
(75 degree back)		
73" OD Construction 4-in-1	LAF0976	1390
78" OD Construction 4-in-1	LAF0977	1475
82" OD Construction 4-in-1	LAF0985	1540
87" OD Construction 4-in-1	LAF0990	1620
(Designed for Track Machines)		
84" OD Construction 4-in-1 (70° back)	LAF0988	1343
90" OD Construction 4-in-1 (70° back)	LAF0992	1434

Price of loader mounting must be added to the attachment price

Choose a mount

MOUNTING		
ADDITIONAL COST MAY APPLY		
	ORDER CODE	SHIP WEIGHT (LBS)
Contact Customer Service at (833) 723-1843		

Decide what options you want

OPTIONS		
EXCLUSIVE TO FFC BUCKETS		
	ORDER CODE	SHIP WEIGHT (LBS)
Extra Heavy-Duty Toothbar for Buckets with Bolt-On Edge		
For Bucket LAF0976 with 8 teeth	LAF9173-FF41	
For Bucket LAF0977 with 9 teeth	LAF9179-FF41	
For Bucket LAF0985 with 9 teeth	LAF9183-FF41	
For Bucket LAF0988	10640	
For Bucket LAF0992	10641	

The blue information bar will tell you what is included in the price and what you need to choose to order a complete attachment. It may also include other helpful information.



INCLUDES: FLAIL MOWER ASSEMBLY. SHIPS WITHOUT HOSES AND COUPLERS DUE TO VARIATIONS BETWEEN MACHINES WITH REGARDS TO HYDRAULIC COUPLER PLACEMENT. TO ORDER :CHOOSE FLAIL MOWER ASSEMBLY AND MOUNT.

The warning box contains important information pertaining to the attachment and prime mover and/or other safety information.

IMPORTANT: FFC Skid-Steer buckets have a 70° angle on the back. This may increase or decrease the effective rollback and dump angles of your Skid-Steer. Specify Skid-Steer make and model when ordering.

IMPORTANT: Prime Movers with tracks and with an operating weight of 7,000 lbs. or more MUST have port reliefs installed on the prime mover's main control valve to protect both sides of the auxiliary circuit.

If you have any questions about placing your order, contact Customer Service at (833) 723-1843.

ADAPTERS



ADAPTERS

ADAPTER PLATES FOR SKID-STEER LOADERS



ADAPTERS

DROP HEIGHT ADAPTER



- Clamps to existing skid-steer loader mounted attachments
- Lowers attachment by 2.38"
- Use with track over tire machines or oversized tires

DROP HEIGHT	ORDER CODE	SHIP WEIGHT (LBS)
drop height adapter	108953	50

TILT ATTACH



- Attaches to skid-steer universal hitch to tilt 14° left and right
- Tilts buckets and landscaping implements for precise grading and leveling
- Trenchers can be tilted to cut a vertical trench

TILT ATTACH	ORDER CODE	SHIP WEIGHT (LBS)
tilt attach heavy-duty	17446	400
66" hose kit for standard & heavy duty models	103577	10
94" hose kit for standard & heavy duty models	103603	10
Required to Operate Additional Hydraulic Attachments		
universal valve package	88725	23

ADAPTER HARNESS FOR IN-CAB CONTROL (REQUIRES ONE OF THE BELOW) ONLY COMPATIBLE WITH VALVE PACKAGE	ORDER CODE	SHIP WEIGHT (LBS)
Control box w/ power lead	28-10754	5
7-pin for Bobcat	07-9548	5
Wire Harness (multi function in cab controls) for CNH, JCB, Bobcat, Mustang, Kubota, Takeuchi, Volvo 14 Pin-8 Pin	LAF9360-0000	5
14 pin - 8 pin for CAT XPS D	119740	5
14 pin - 8 pin for CAT XHP D	119741	5
8-pin, Fits F2-H Series, for CAT B and C	07-10170	5
8-pin for Komatsu	07-10057	5
14-pin, Fits All Series, for John Deere-8 button	LAF9361	5

ADAPTER PLATES FOR SKID-STEER LOADERS CONT.

UNIVERSAL MOUNT TO CATEGORY I OR II 3-POINT HITCH



- Attaches to skid-steer universal hitch for using 3-point hitch attachments

UNIVERSAL MOUNT TO CATEGORY I OR II 3-POINT HITCH		
	ORDER CODE	SHIP WEIGHT (LBS)
adapter plate	88020	210

UNIVERSAL WELD-ON



- Welds to your implement to convert it to a universal hitch

UNIVERSAL WELD-ON ADAPTER		
	ORDER CODE	SHIP WEIGHT (LBS)
universal weld-on adapter	86914	75
heavy-duty universal weld-on adapter	88987	123

ADAPTER PLATES FOR COMPACT TRACTORS



COMPACT TRACTOR ADAPTER



COMPACT TRACTOR ADAPTER		
	ORDER CODE	SHIP WEIGHT (LBS)
attaches to tractor 3-point, category 1 & 2 for using Skid-Steer universal attachments	87640	137
attaches to skid-steer universal hitch for using 3-point hitch attachments	88020	210

UNIVERSAL ADAPTER TO OEM HITCHES



UNIVERSAL ADAPTER TO OEM HITCHES		
	ORDER CODE	SHIP WEIGHT (LBS)
blank adapter (weld your own hitch)	12626	400
Cat IT/TH	12670	325
Ingersoll-Rand VR530 / VR642 (post-2002) / VR843 / 1044 / 1056	12492	359
JCB 506/508, Terex, Upright	11634	302
JCB Q-fit	13228	400
Manitou/New Holland LM5000 Series	17176	316
New Holland-Versattach	13228	400
SkyTrak/New Holland M400/Case TX Series	11634	302
Universal Adapter to QCP 7000	122689	530

ADAPTERS

ADAPTER PLATES FOR TRACTOR LOADERS/BACKHOES



BLANK ADAPTER PLATE



ADAPTER PLATE - BLANK	ORDER CODE	SHIP WEIGHT (LBS)
Cat IT/TH	12246	250
JCB 210S / 212S	12067	250
JCB Q-fit	12076	250
JCB Q-fit equipped 214/215/217 heavy duty	12325	300

ADAPTER PLATES FOR TRACTOR LOADERS/BACKHOES AND WHEEL LOADERS



BLANK ADAPTER PLATE



ADAPTER PLATE - BLANK	ORDER CODE	SHIP WEIGHT (LBS)
Cat IT/TH	12246	250
JCB 406/Volvo L25 ZL402	13107	184
JCB 407/409 BZ w/ Zettlemeyer ZL602	12068	400
JCB 411/416/426/436 Volvo L40-L 120 with HT coupler, ISO 23727	12072	400
John Deere 244J/304J/Volvo L30/L35/ZL602	12068	400
Komatsu WA75/WA85/WA95	12068	400
Wacker WL50	117106	94

ADAPTER PLATES FOR WHEEL LOADERS



UNIVERSAL ADAPTER TO OEM HITCHES



UNIVERSAL ADAPTER TO OEM HITCHES	ORDER CODE	SHIP WEIGHT (LBS)
Universal Adapter, ISO 23727 / Zettlemeyer ZL802	13434	325
Universal Adapter, JRB 416	13465	398
blank adapter (weld your own hitch)	12626	400
Atlas / Coyote AR95	12760	245
Atlas / Coyote AR45E, AR65, 55 , 75, 85	12712	330
Cat IT/TH	12670	325
John Deere 304J - 244J ZL602	14820	400
Kawasaki 45ZV-2	119091	335
Komatsu WA65 ZL602	14820	400
Komatsu WA75 / 85 / 95 (this is a bolt-on plate that locks into the universal female and converts the unit to the host machine - stays with each attachment)	12532	245
Komatsu WA75 / 85 / 95 & Zettlemeyer ZL602	14820	400
Takeuchi TW65	108869	345
TCM E804 / E806	12193	400
Volvo L30-L35 ZL602	14820	400
Volvo ZL402 (this is a bolt-on plate that locks into the universal female and converts the unit to the host machine - stays with each attachment)	33670	245

AUGERS



AUGERS

PENGO CS SERIES AUGER DRIVES

NEW PRODUCT



- Advanced gearing standard for increased life and efficiency
- Secure lock shaft
- Compact housing design for easy handling and increased strength and durability
- Oversized bearing for improved load handling
- Extreme shaft seals for reduced service intervals
- Compact, high torque, efficient hydraulic motors for improved drilling productivity
- Easy access service points for user friendly maintenance
- Full connection contact between auger hub and auger drive unit

	CS 11-12	CS 16-15	CS 20-17	CS 22-20	CS 28-22	CS 35-25
CARRIER WEIGHT MIN	1.8 K-LBS	2.2 K-LBS	4.4 K-LBS	5.5 K-LBS	6.6 K-LBS	6.6 K-LBS
CARRIER WEIGHT MAX	3.3 K-LBS	5.5 K-LBS	6.6 K-LBS	8.8 K-LBS	9.9 K-LBS	11.0 K-LBS
PRODUCT WEIGHT	130 LBS	130 LBS	130 LBS	156 LBS	156 LBS	158 LBS
OIL FLOW RATE MIN	5.3 GPM	6.6 GPM	9.2 GPM	9.2 GPM	10.6 GPM	10.6 GPM
OIL FLOW RATE MAX	11.9 GPM	14.5 GPM	17.2 GPM	19.8 GPM	22.5 GPM	25.1 GPM
OIL PRESSURE MIN	2031 PSI	2031 PSI	2031 PSI	2321 PSI	2321 PSI	2321 PSI
OIL PRESSURE MAX	3046 PSI	3481 PSI	3481 PSI	3771 PSI	3771 PSI	3771 PSI
ROTATIONAL SPEED MIN	45 RPM	45 RPM	51 RPM	48 RPM	44 RPM	35 RPM
ROTATIONAL SPEED MAX	101 RPM	98 RPM	94 RPM	103 RPM	93 RPM	83 RPM
OUTPUT TORQUE MIN	734 FT-LBS	918 FT-LBS	1138 FT-LBS	1362 FT-LBS	1716 FT-LBS	2149 FT-LBS
OUTPUT TORQUE MAX	1101 FT-LBS	1574 FT-LBS	1952 FT-LBS	2213 FT-LBS	2788 FT-LBS	3492 FT-LBS
CASE PRESSUREE MAX	508 PSI	551 PSI	580 PSI	580 PSI	653 PSI	580 PSI
SHAFT TYPE	2 IN. HEX / 2.563 IN. ROUND	2 IN. HEX / 2.563 IN. ROUND	2 IN. HEX / 2.563 IN. ROUND	2 IN. HEX / 2.563 IN. ROUND	2 IN. HEX / 2.563 IN. ROUND	2 IN. HEX / 2.563 IN. ROUND

	CS 41-25	CS 38-30	CS 49-36	CS 39-37	CS 49-45	CS 62-48
CARRIER WEIGHT MIN	6.6 K-LBS	8.8 K-LBS	9.9 K-LBS	8.8 K-LBS	11.0 K-LBS	15.4 K-LBS
CARRIER WEIGHT MAX	12.1 K-LBS	13.2 K-LBS	15.4 K-LBS	13.2 K-LBS	17.6 K-LBS	22.0 K-LBS
PRODUCT WEIGHT	161 LBS	253 LBS	255 LBS	268 LBS	271 LBS	273 LBS
OIL FLOW RATE MIN	10.6 GPM	15.9 GPM	18.5 GPM	15.9 GPM	18.5 GPM	18.5 GPM
OIL FLOW RATE MAX	25.1 GPM	30.4 GPM	34.3 GPM	37.0 GPM	39.6 GPM	42.3 GPM
OIL PRESSURE MIN	2321 PSI	2321 PSI	2321 PSI	2321 PSI	2321 PSI	2031 PSI
OIL PRESSURE MAX	3771 PSI	3771 PSI	3771 PSI	3771 PSI	3771 PSI	3771 PSI
ROTATIONAL SPEED MIN	27 RPM	47 RPM	44 RPM	51 RPM	49 RPM	39 RPM
ROTATIONAL SPEED MAX	65 RPM	91 RPM	81 RPM	118 RPM	105 RPM	89 RPM
OUTPUT TORQUE MIN	2539 FT-LBS	2364 FT-LBS	3025 FT-LBS	2394 FT-LBS	3031 FT-LBS	3203 FT-LBS
OUTPUT TORQUE MAX	4125 FT-LBS	3841 FT-LBS	4916 FT-LBS	3890 FT-LBS	4925 FT-LBS	5948 FT-LBS
CASE PRESSUREE MAX	580 PSI	580 PSI	580 PSI	319 PSI	406 PSI	566 PSI
SHAFT TYPE	2 IN. HEX / 2.563 IN. ROUND	2.5 IN. HEX	2.5 IN. HEX	2.5 IN. HEX	2.5 IN. HEX	2.5 IN. HEX

CS AUGER DRIVES CONTINUED NEXT PAGE

PENGO CS SERIES AUGER DRIVES CONT.

CS SERIES AUGER DRIVES FOR COMPACT TOOL CARRIERS, TRACTORS, TELEHANDLERS, BACKHOE LOADERS, SKID-STEER LOADERS, MINI EXCAVATORS, AND EXCAVATORS



INCLUDES: AUGER DRIVE, HOSES, AND PIN.
YOU MUST ORDER MOUNTING KIT, FLUSH FACE COUPLERS, AUGER BITS, EXTENSIONS SEPARATELY

CS SERIES AUGER DRIVES Hose routed out the side		ORDER CODE	SHIP WEIGHT (LBS)
CS 11-12 2.56" Round Auger Drive, 0.8 - 2 MT		810231N	130
CS 11-12 2" Hex Auger Drive, 0.8 - 2 MT		810232N	130
CS 16-15 2.56" Round Auger Drive, 1 - 2.5 MT		810237N	130
CS 16-15 2" Hex Auger Drive, 1 - 2.5 MT		810238N	130
CS 20-17 2.56" Round Auger Drive, 2 - 3 MT		810243N	130
CS 20-17 2" Hex Auger Drive, 2 - 3 MT		810244N	130
CS 22-20 2.56" Round Auger Drive, 2.5 - 4 MT		810330N	156
CS 22-20 2" Hex Auger Drive, 2.5 - 4 MT		810331N	156
CS 28-22 2.56" Round Auger Drive, 3 - 4.5 MT		810335N	156
CS 28-22 2" Hex Auger Drive, 3 - 4.5 MT		810336N	156
CS 35-25 2.56" Round Auger Drive, 3.5 - 5 MT		810340N	158
CS 35-25 2" Hex Auger Drive, 3.5 - 5 MT		810341N	158
CS 41-25 2.56" Round Auger Drive, 4 - 6 MT		810345N	161
CS 41-25 2" Hex Auger Drive, 4 - 6 MT		810346N	161
CS 38-30 2.5" Hex Auger Drive, 4 - 6 MT		810395N	253
CS 49-36 2.5" Hex Auger Drive, 4.5 - 7 MT		810398N	255
CS 39-37 2.5" Hex Auger Drive, 4.5 - 7 MT		810404N	268
CS 49-45 2.5" Hex Auger Drive, 5 - 8 MT		810407N	271
CS 62-48 2.5" Hex Auger Drive, 7 - 10 MT		810410N	273

*To mount CS drives to existing McMillen mounts, you must order swivel part number 810098N

AUGERS

PENGO CS SERIES KITTED BUNDLES



INCLUDES: MOUNT, DRIVE, AND SELECT BUNDLES INCLUDE QUICK DISCONNECT FITTINGS. SEE TABLE FOR PROPER OUTPUT SHAFT AND DETAILS.

CS SERIES KITTED BUNDLES FOR SKID STEER LOADERS



SKID STEER MOUNT BUNDLES					
Hose routed out the side					
ORDER CODE	DESCRIPTION	OUTPUT SHAFT	MOUNT	QD INCLUDED	SHIP WEIGHT (LBS)
810237N-0022	CS 16-15 AUGER DRIVE	2.563 IN ROUND	Universal SSL	1/2	277
810238N-0022	CS 16-15 AUGER DRIVE	2 IN HEX	Universal SSL	1/2	277
810335N-0022	CS 28-22 AUGER DRIVE	2.563 IN ROUND	Universal SSL	1/2	305
810336N-0022	CS 28-22 AUGER DRIVE	2 IN HEX	Universal SSL	1/2	305
810340N-0022	CS 35-25 AUGER DRIVE	2.563 IN ROUND	Universal SSL	1/2	305
810341N-0022	CS 35-25 AUGER DRIVE	2 IN HEX	Universal SSL	1/2	305
810345N-0022	CS 41-25 AUGER DRIVE	2.563 IN ROUND	Universal SSL	1/2	307
810346N-0022	CS 41-25 AUGER DRIVE	2 IN HEX	Universal SSL	1/2	307
810410N-9925	CS 62-48 AUGER DRIVE	2.5 IN HEX	Universal SSL	3/4	433

CS SERIES KITTED BUNDLES FOR QUICK CHANGE BETWEEN SKID STEERS AND EXCAVATORS



EXCAVATOR AND SKID STEER C&P 027 TO SKID STEER QUICK CHANGE MOUNT BUNDLES					
Hose routed out the side					
ORDER CODE	DESCRIPTION	OUTPUT SHAFT	MOUNT	SHIP WEIGHT (LBS)	
810335N-E0852-0022	CS 28-22 AUGER DRIVE	2.563 IN ROUND	C&P 027	635	
810336N-E0852-0022	CS 28-22 AUGER DRIVE	2 IN HEX	C&P 027	633	
810340N-E0852-0022	CS 35-25 AUGER DRIVE	2.563 IN ROUND	C&P 027	633	
810341N-E0852-0022	CS 35-25 AUGER DRIVE	2 IN HEX	C&P 027	633	
810345N-E0852-0022	CS 41-25 AUGER DRIVE	2.563 IN ROUND	C&P 027	635	
810346N-E0852-0022	CS 41-25 AUGER DRIVE	2 IN HEX	C&P 027	635	

CS SERIES KITTED BUNDLES FOR EXCAVATORS



EXCAVATOR MOUNT BUNDLES					
Hose routed out the side					
ORDER CODE	DESCRIPTION	OUTPUT SHAFT	MOUNT	SHIP WEIGHT (LBS)	
810335N-E0852	CS 28-22 AUGER DRIVE	2.563 IN ROUND	C&P 027	278	
810336N-E0852	CS 28-22 AUGER DRIVE	2 IN HEX	C&P 027	276	
810340N-E0852	CS 35-25 AUGER DRIVE	2.563 IN ROUND	C&P 027	276	
810341N-E0852	CS 35-25 AUGER DRIVE	2 IN HEX	C&P 027	276	
810345N-E0852	CS 41-25 AUGER DRIVE	2.563 IN ROUND	C&P 027	278	
810346N-E0852	CS 41-25 AUGER DRIVE	2 IN HEX	C&P 027	278	
810335N-E0333	CS 28-22 AUGER DRIVE	2.563 IN ROUND	C&P 030	400	
810336N-E0333	CS 28-22 AUGER DRIVE	2 IN HEX	C&P 030	398	
810340N-E0333	CS 35-25 AUGER DRIVE	2.563 IN ROUND	C&P 030	398	
810341N-E0333	CS 35-25 AUGER DRIVE	2 IN HEX	C&P 030	398	
810345N-E0333	CS 41-25 AUGER DRIVE	2.563 IN ROUND	C&P 030	400	
810346N-E0333	CS 41-25 AUGER DRIVE	2 IN HEX	C&P 030	400	

PENGO CS SERIES AUGER DRIVES - MOUNTS

Quick Attach Mount



Double Pin Mount



Universal Mount



SSL Mount



CS SERIES AUGERS	ORDER CODE	SHIP WEIGHT (LBS)
Quick Attach Mount		
C&P 027 COUPLER, CRADLE-READY	239261	101
C&P 030 COUPLER, CRADLE-READY	239262	233
KUBOTA KX41-3/U15, U17, KX018-4, K7966, CRADLE NOT AVAILABLE	239263	79
KUBOTA KX040, KX71-3, KX91-3, KX121-3, U35, KX033-K7870, CRADLE-READY	239264	117
KUBOTA KX057, U55, USA ONLY K7915, CRADLE-READY	239265	140
KUBOTA KX161-3, U45, K9940, CRADLE NOT AVAILABLE	239266	121
KUBOTA KX080 MINI EXCAVATOR K7402, CRADLE-READY	239267	169
JD 27D ZTS/35D ZTS MINI EXCAVATOR, CRADLE NOT AVAILABLE	239268	96
JOHN DEERE WEDGE-STYLE COUPLER WITH 9" EAR SPACING, INCLUDES CRADLE	239257	127
BOBCAT XCHANGE QA	239282	40
Double Pin Mount		
PIN GRAB, YANMAR VIO27/VIO35, CRADLE NOT AVAILABLE	239270	73
PIN GRAB, CAT 303.5, 303, 304, DX35Z, CX37C, R35Z, CRADLE-READY	239271	116
PIN GRAB, YANMAR VIO45/55/40/50, CX60, CRADLE NOT AVAILABLE	239272	112
PIN GRAB, HYUNDAI R60CR-9 / CASE CX57C, CX60C, CRADLE-READY	239273	182
PIN GRAB, CAT 305/305.5 / DOOSAN DX62, CRADLE-READY	239274	139
PIN GRAB, YANMAR VIO75/B7/SV100, KOM PC78, JD 75G85G, CRADLE NOT AVAILABLE	239275	138
Universal Mounts		
WELD ON PLATE W/SWIVEL LINK, NO CRADLE	239276	82
BOLT ON PLATE W/SWIVEL LINK	239277	82
SSL Mount		
SSL MOUNT OFFSET, WITH CRADLE	239278	159
SSL MOUNT WITH CRADLE	239279	150
SSL TO C&P 027 ADAPTER (AUGER DRIVE REQUIRED TO HAVE 239261 COUPLER)	13-18456	357
Add on Parts		
BOLT-ON CRADLE FOR CRADLE-READY MOUNTS	21670	15.5
CS SWIVEL - ADAPTOR FOR MCMILLEN MOUNTS	810098N	11

AUGERS

AUGERS

PENGO AUGER DRIVES DT-5 DRILLING 2-SPEED PLANETARY DRIVE



- Removable Top Section
- Standard cross-over pressure relief system that is designed to protect the motor from pressure spikes and potential overload conditions
- Attached Manual Holder for Quick Access
- Highly Efficient Gearbox designed for long duty cycles
- 2 1/2" Hex Output Shaft

Hydraulic Motor Information	
Displacement	2.98 cu/in (97.6cc)
Motor Type	Two Speed Bi-Directional
Motor Output Shaft	1 1/4" Spline 14T
Motor Mount	SAE - C 4 Bolt
Motor Ports	1 5/8" - 12 UN-2B
Cross Over Pressure Relief	Set at 3,100 psi

Planetary Gearbox Information	
Gearbox Type	Planetary Two Stage
Reduction Ratio	25.36:1
Output Shaft	2 1/2" Hex
Internal Oil Capacity	2.0 Gallons
Oil Type	SAE 80W90 GL-5
Shaft Pull Out (lbs.)	22,500 lbs.

Output Speed		
Flow	LOW	HIGH
20 GPM	25 RPM	50 RPM
25 GPM	31 RPM	63 RPM
30 GPM	38 RPM	75 RPM
35 GPM	44 RPM	88 RPM
40 GPM	50 RPM	100 RPM

Output Torque (LT/HS)		
PRESSURE	THEORETICAL	ACTUAL
1000 PSI	1002 FT/LB	822 FT/LB
1200 PSI	1202 FT/LB	986 FT/LB
1400 PSI	1402 FT/LB	1150 FT/LB
1600 PSI	1603 FT/LB	1314 FT/LB
1800 PSI	1803 FT/LB	1478 FT/LB
2000 PSI	2004 FT/LB	1643 FT/LB
2200 PSI	2204 FT/LB	1807 FT/LB
2400 PSI	2404 FT/LB	1971 FT/LB
2600 PSI	2605 FT/LB	2136 FT/LB
2800 PSI	2805 FT/LB	2300 FT/LB
3000 PSI	3006 FT/LB	2465 FT/LB

Output Torque (HT/LS)		
PRESSURE	THEORETICAL	ACTUAL
1000 PSI	2004 FT/LB	1643 FT/LB
1200 PSI	2404 FT/LB	1971 FT/LB
1400 PSI	2805 FT/LB	2300 FT/LB
1600 PSI	3206 FT/LB	2629 FT/LB
1800 PSI	3607 FT/LB	2958 FT/LB
2000 PSI	4008 FT/LB	3287 FT/LB
2200 PSI	4409 FT/LB	3615 FT/LB
2400 PSI	4809 FT/LB	3943 FT/LB
2600 PSI	5210 FT/LB	4272 FT/LB
2800 PSI	5611 FT/LB	4601 FT/LB
3000 PSI	6012 FT/LB	4930 FT/LB

Note that both theoretical and actual torque values are listed, but that Pengo recommends to go by ACTUAL torque listings.

DT-5 DRILLING AUGER DRIVE FOR SKID-STEER LOADERS AND 3T-6T MINI EXCAVATORS



INCLUDES: AUGER DRIVE ONLY. YOU MUST ORDER MOUNTING KIT, AUGER BITS, AND EXTENSIONS SEPARATELY.

DT-5 DRILLING AUGER DRIVE	ORDER CODE	SHIP WEIGHT (LBS)
DT-5 2.5" Hex Auger Drive 20-40 GPM	610173	645

PENGO AUGER DRIVES DT-15 DRILLING 2-SPEED PLANETARY DRIVE



- Removable Top Section
- Standard cross-over pressure relief system that is designed to protect the motor from pressure spikes and potential overload conditions
- Attached Manual Holder for Quick Access
- Highly Efficient Gearbox designed for long duty cycles
- 3" Hex Output Shaft

Hydraulic Motor Information	
Displacement	17.8 cu/in (293cc)
Motor Type	Two Speed Bi-Directional
Motor Output Shaft	1 1/4" Spline 14T
Motor Mount	SAE - C 4 Bolt
Motor Ports	1 5/8" - 12 UN-2B
Cross Over Pressure Relief	Set at 3,100 psi

Planetary Gearbox Information	
Gearbox Type	Planetary Two Stage
Reduction Ratio	26.52:1
Output Shaft	3" Hex
Internal Oil Capacity	3.0 Gallons
Oil Type	SAE 80W90 GL-5
Shaft Pull Out (lbs.)	22,500 lbs.

Output Speed		
Flow	LOW	HIGH
20 GPM	8 RPM	16 RPM
30 GPM	12 RPM	24 RPM
40 GPM	16 RPM	32 RPM
50 GPM	20 RPM	40 RPM

Output Torque (LT/HS)		
PRESSURE	THEORETICAL	ACTUAL
1000 PSI	3145 FT/LB	2579 FT/LB
1200 PSI	3775 FT/LB	3096 FT/LB
1400 PSI	4404 FT/LB	3611 FT/LB
1600 PSI	5033 FT/LB	4127 FT/LB
1800 PSI	5662 FT/LB	4643 FT/LB
2000 PSI	6291 FT/LB	5159 FT/LB
2200 PSI	6920 FT/LB	5674 FT/LB
2400 PSI	7550 FT/LB	6191 FT/LB
2600 PSI	8179 FT/LB	6707 FT/LB
2800 PSI	8808 FT/LB	7223 FT/LB
3000 PSI	9437 FT/LB	7738 FT/LB

Output Torque (HT/LS)		
PRESSURE	THEORETICAL	ACTUAL
1000 PSI	6291 FT/LB	5159 FT/LB
1200 PSI	7550 FT/LB	6191 FT/LB
1400 PSI	8808 FT/LB	7223 FT/LB
1600 PSI	10066 FT/LB	8254 FT/LB
1800 PSI	11325 FT/LB	9287 FT/LB
2000 PSI	12583 FT/LB	10318 FT/LB
2200 PSI	13841 FT/LB	11350 FT/LB
2400 PSI	15100 FT/LB	12382 FT/LB
2600 PSI	16358 FT/LB	13414 FT/LB
2800 PSI	17616 FT/LB	14445 FT/LB
3000 PSI	18875 FT/LB	15478 FT/LB

Note that both theoretical and actual torque values are listed, but that Pengo recommends to go by ACTUAL torque listings.

DT-15 DRILLING AUGER DRIVE FOR 12T-20T EXCAVATORS



INCLUDES: AUGER DRIVE ONLY. YOU MUST ORDER MOUNTING KIT, AUGER BITS, AND EXTENSIONS SEPARATELY.

DT-15 DRILLING AUGER DRIVE	ORDER CODE	SHIP WEIGHT (LBS)
DT-15 3" Hex Auger Drive 20-50 GPM	610174	825

AUGERS

PENGO AUGER DRIVES

DV-20 DRILLING VARIABLE SPEED PLANETARY DRIVE



- Removable Top Section
- Motor equipped with Quick Coupler
- Powerful and efficient motor
- Attached Manual Holder for Quick Access
- Highly Efficient Gearbox designed for long duty cycles
- 3" Hex Output Shaft

Hydraulic Motor Information	
Displacement	8.25 cu/in (135cc)
Motor Type	Variable Speed Bi-Directional
Motor Output Shaft	8/16" Spline 13T
Motor Mount	SAE - D 2 Bolt
Motor Ports	Code 62 SAE Split Flange
Cross Over Pressure Relief	None

Planetary Gearbox Information	
Gearbox Type	Planetary Three Stage
Reduction Ratio	60.56:1
Output Shaft	3" Hex
Internal Oil Capacity	3.0 Gallons
Oil Type	SAE 80W90 GL-5
Shaft Pull Out (lbs.)	45,000 lbs.

Output Speed		
Flow	LOW	HIGH
40 GPM	16 RPM	27 RPM
45 GPM	18 RPM	30 RPM
50 GPM	20 RPM	33 RPM
55 GPM	22 RPM	37 RPM
60 GPM	24 RPM	40 RPM

Output Torque (LT/HS)		
PRESSURE	THEORETICAL	ACTUAL
2000 PSI	7845 FT/LB	6668 FT/LB
2200 PSI	8630 FT/LB	7336 FT/LB
2400 PSI	9414 FT/LB	8002 FT/LB
2600 PSI	10199 FT/LB	8669 FT/LB
2800 PSI	10984 FT/LB	9336 FT/LB
3000 PSI	11768 FT/LB	10003 FT/LB
3200 PSI	12553 FT/LB	10670 FT/LB
3400 PSI	13337 FT/LB	11336 FT/LB
3600 PSI	14122 FT/LB	12004 FT/LB
3800 PSI	14907 FT/LB	12671 FT/LB
4000 PSI	15691 FT/LB	13337 FT/LB

Output Torque (HT/LS)		
PRESSURE	THEORETICAL	ACTUAL
2000 PSI	13239 FT/LB	11253 FT/LB
2200 PSI	14563 FT/LB	12379 FT/LB
2400 PSI	15887 FT/LB	13504 FT/LB
2600 PSI	17211 FT/LB	14629 FT/LB
2800 PSI	18535 FT/LB	15755 FT/LB
3000 PSI	19859 FT/LB	16880 FT/LB
3200 PSI	21183 FT/LB	18006 FT/LB
3400 PSI	22507 FT/LB	19131 FT/LB
3600 PSI	23831 FT/LB	20256 FT/LB
3800 PSI	25155 FT/LB	21382 FT/LB
4000 PSI	26479 FT/LB	22507 FT/LB

Note that both theoretical and actual torque values are listed, but that Pengo recommends to go by ACTUAL torque listings.

DV-20 DRILLING AUGER DRIVE FOR 12T-20T EXCAVATORS



INCLUDES: AUGER DRIVE ONLY. YOU MUST ORDER MOUNTING KIT, AUGER BITS, AND EXTENSIONS SEPARATELY.

DV-20 DRILLING AUGER DRIVE	ORDER CODE	SHIP WEIGHT (LBS)
DV-20 3" Hex Auger Drive 40-60 GPM	610442	880

PENGO AUGER DRIVES DV-30 DRILLING VARIABLE SPEED PLANETARY DRIVE



- Removable Top Section
- Motor equipped with Quick Coupler
- Powerful and efficient motor
- Attached Manual Holder for Quick Access
- Highly Efficient Gearbox designed for long duty cycles
- 4" Square Output Shaft

Hydraulic Motor Information		Planetary Gearbox Information	
Displacement	10.06 cu/in (165cc)	Gearbox Type	Planetary Three Stage
Motor Type	Variable Speed Bi-Directional	Reduction Ratio	69.7:1
Motor Output Shaft	8/16" Spline 13T	Output Shaft	4" Square
Motor Mount	SAE - D 2 Bolt	Internal Oil Capacity	3.17 Gallons
Motor Ports	Code 62 SAE Split Flange	Oil Type	SAE 80W90 GL-5
Cross Over Pressure Relief	None	Shaft Pull Out (lbs.)	60,000 lbs.

Output Speed			Output Torque (LT/HS)			Output Torque (HT/LS)		
Flow	LOW	HIGH	PRESSURE	THEORETICAL	ACTUAL	PRESSURE	THEORETICAL	ACTUAL
40 GPM	11 RPM	27 RPM	2000 PSI	7675 FT/LB	6524 FT/LB	2000 PSI	18624 FT/LB	15830 FT/LB
45 GPM	13 RPM	31 RPM	2200 PSI	8442 FT/LB	7176 FT/LB	2200 PSI	20486 FT/LB	17413 FT/LB
50 GPM	14 RPM	34 RPM	2400 PSI	9210 FT/LB	7829 FT/LB	2400 PSI	22349 FT/LB	18997 FT/LB
55 GPM	15 RPM	37 RPM	2600 PSI	9978 FT/LB	8481 FT/LB	2600 PSI	24211 FT/LB	20579 FT/LB
60 GPM	17 RPM	41 RPM	2800 PSI	10745 FT/LB	9133 FT/LB	2800 PSI	26073 FT/LB	22162 FT/LB
			3000 PSI	11513 FT/LB	9786 FT/LB	3000 PSI	27936 FT/LB	23746 FT/LB
			3200 PSI	12280 FT/LB	10438 FT/LB	3200 PSI	29798 FT/LB	25328 FT/LB
			3400 PSI	13048 FT/LB	11091 FT/LB	3400 PSI	31661 FT/LB	26912 FT/LB
			3600 PSI	13815 FT/LB	11743 FT/LB	3600 PSI	33523 FT/LB	28495 FT/LB
			3800 PSI	14583 FT/LB	12396 FT/LB	3800 PSI	35386 FT/LB	30078 FT/LB
			4000 PSI	15350 FT/LB	13048 FT/LB	4000 PSI	37248 FT/LB	31661 FT/LB

Note that both theoretical and actual torque values are listed, but that Pengo recommends to go by ACTUAL torque listings.

DV-30 DRILLING AUGER DRIVE FOR 15T-25T EXCAVATORS



i INCLUDES: AUGER DRIVE ONLY. YOU MUST ORDER MOUNTING KIT, AUGER BITS, AND EXTENSIONS SEPARATELY.

DV-30 DRILLING AUGER DRIVE	ORDER CODE	SHIP WEIGHT (LBS)
DV-30 4" Square Auger Drive 40-60 GPM	610384	1250

AUGERS

PENGO AUGER DRIVES

DV-40 DRILLING VARIABLE SPEED PLANETARY DRIVE



- Removable Top Section
- Motor equipped with Quick Coupler
- Powerful and efficient motor
- Attached Manual Holder for Quick Access
- Highly Efficient Gearbox designed for long duty cycles
- 130mm Square Output Shaft

Hydraulic Motor Information	
Displacement	10.06 cu/in (165cc)
Motor Type	Variable Speed Bi-Directional
Motor Output Shaft	8/16" Spline 13T
Motor Mount	SAE - D 2 Bolt
Motor Ports	Code 62 SAE Split Flange
Cross Over Pressure Relief	None

Planetary Gearbox Information	
Gearbox Type	Planetary Three Stage
Reduction Ratio	83.78:1
Output Shaft	130mm Square
Internal Oil Capacity	4.0 Gallons
Oil Type	SAE 80W90 GL-5
Shaft Pull Out (lbs.)	60,000 lbs.

Output Speed		
Flow	LOW	HIGH
40 GPM	9 RPM	23 RPM
45 GPM	10 RPM	25 RPM
50 GPM	12 RPM	28 RPM
55 GPM	13 RPM	31 RPM
60 GPM	14 RPM	34 RPM

Output Torque (LT/HS)		
PRESSURE	THEORETICAL	ACTUAL
2000 PSI	9225 FT/LB	7841 FT/LB
2200 PSI	10148 FT/LB	8626 FT/LB
2400 PSI	11071 FT/LB	9410 FT/LB
2600 PSI	11993 FT/LB	10194 FT/LB
2800 PSI	12916 FT/LB	10979 FT/LB
3000 PSI	13838 FT/LB	11762 FT/LB
3200 PSI	14761 FT/LB	12547 FT/LB
3400 PSI	15684 FT/LB	13331 FT/LB
3600 PSI	16606 FT/LB	14115 FT/LB
3800 PSI	17529 FT/LB	14900 FT/LB
4000 PSI	18451 FT/LB	15683 FT/LB

Output Torque (HT/LS)		
PRESSURE	THEORETICAL	ACTUAL
2000 PSI	22386 FT/LB	19028 FT/LB
2200 PSI	24625 FT/LB	20931 FT/LB
2400 PSI	26863 FT/LB	22834 FT/LB
2600 PSI	29102 FT/LB	24737 FT/LB
2800 PSI	31341 FT/LB	26640 FT/LB
3000 PSI	33579 FT/LB	28542 FT/LB
3200 PSI	35818 FT/LB	30445 FT/LB
3400 PSI	38057 FT/LB	32348 FT/LB
3600 PSI	40295 FT/LB	34251 FT/LB
3800 PSI	42534 FT/LB	36154 FT/LB
4000 PSI	44772 FT/LB	38056 FT/LB

Note that both theoretical and actual torque values are listed, but that Pengo recommends to go by ACTUAL torque listings.

DV-40 DRILLING AUGER DRIVE FOR 15T-25T EXCAVATORS



INCLUDES: AUGER DRIVE ONLY. YOU MUST ORDER MOUNTING KIT, AUGER BITS, AND EXTENSIONS SEPARATELY.

DV-40 DRILLING AUGER DRIVE	ORDER CODE	SHIP WEIGHT (LBS)
DV-40 130MM Square Auger Drive 40-60 GPM	610385	1500

AUGER DRIVES

PENGO AUGER DRIVE ACCESSORIES	ORDER CODE	SHIP WEIGHT (LBS)
Pin Assembly 45mm w/ retainers	660558	
Link Arm 45mm Series	660555	
Adapter Drive Tool, H-250 paint	158132	
Adapter Drive Tool, H-300 paint	158137	
Pin 75mm x 10.13	660554	
Link Arm, Pain 7" round 75mm pin	610202	
Adapter Drive Tool, S-130mm paint	610301	

PENGO AUGER MOUNTING KITS AND COMPONENTS



ALL MOUNTS ARE ORGANIZED BY PRIME MOVER AND STYLE (PENDULUM/DIPPER, DIRECT PIN-ON/PIN-GRABBER, OR QUICK ATTACH) MOUNTS ARE ALSO CHARACTERIZED BY CRADLE TYPE

QUICK ATTACH MOUNTING BRACKETS



NOTE: IF YOUR MOUNT IS NOT LISTED CALL (833) 723-1843

PENGO AUGER MODELS DV30, DV40, RT30, RT40 - 75MM

ORDER CODE

SHIP WEIGHT
(LBS)

Dedicated Quick Attach Mount

Komatsu PC 200 TALL	661840
Bobcat E35	661862
Bobcat E85 NO PINS	662067
Case CX-350	662044
Case CX 145	661773
Case CX-240	661200
Case CX-80	661528
Case-210	661844
CAT 303.5E	662074
CAT 303CR	661194
CAT 305.5	661856
CAT 307C	662102
CAT 312	660912
CAT 315-C	661104
CAT 320/322-B	660953
CAT 320	661828
CAT 320D SPEC	662138
CAT 329	661690
CAT 330 L	662124
CAT 336-E	661398
CAT 420-F	661662
CAT-308	661520
CAT 302.5	661849
CAT 320/321 TALL	661350
CAT 320 QC [WIDE]	662082
CAT M322D	662386
CAT 329EL	661834
CAT 330-C	661147
CAT 330 SPEC	662382
CAT 345-F	661550
CAT 4446 BACKHOE	661424
Doosan DX-140	662055
Esco QCK CPLR	660926

MOUNTING BRACKETS FOR EXCAVATORS CONTINUED NEXT PAGE

PENGO AUGER MOUNTING KITS AND COMPONENTS

QUICK ATTACH MOUNTING BRACKETS

PENGO AUGER MODELS DV30, DV40, RT30, RT40 - 75MM	ORDER CODE	SHIP WEIGHT (LBS)
Dedicated Quick Attach Mount		
Hitachi ZX245LC	661911	
Hitachi 200-3 PNT	661296	
Hitachi ZX-450	661451	
Hyundai R290LC-9ALR	661932	
International 35NX	661779	
John Deere 410 BACK HOE	661360	
John Deere 350	661352	
John Deere 160LC	661107	
John Deere 2905	661650	
John Deere 350	661276	
John Deere 85D	661241	
John Deere 85G JR20MPL	662153	
John Deere 245,200	661093	
John Deere 245 G LC	662321	
John Deere 135G	662351	
John Deere 270D	661255	
John Deere 290 GLC 790 DE	661661	
John Deere 470	661580	
Kobelco SK 115, 130 & 135	660960	
Komatsu PC 200-308	661387	
Komatsu PC100 THRU 158	660933	
Komatsu PC-228	662149	
Komatsu PC 210	662360	
Komatsu PC 170	662366	
Kobelco SK-160	661445	
Komatsu PC-228 TALL	661799	
Komatsu PC-240	661748	
Komatsu PC-300	661223	
Komatsu PC360	661803	
Komatsu PC360	662343	
Komatsu PC-50	661025	
Link Belt 160-X2	661442	
Rotoloc 45/55	660927	
Sany 335	661903	
Solar 175	661204	
Takeuchi TB-1140	661820	
Takeuchi TB-145	661620	
Volvo EC240	661616	
Volvo EC-160	661734	
Wacker Neuson E 125	662123	
Yanmar VIO35	661428	
Yanmar SV-100	661210	

PENGO AUGER MOUNTING KITS AND COMPONENTS



ALL MOUNTS ARE ORGANIZED BY PRIME MOVER AND STYLE (PENDULUM/DIPPER, DIRECT PIN-ON/PIN-GRABBER, OR QUICK ATTACH) MOUNTS ARE ALSO CHARACTERIZED BY CRADLE TYPE

END OF STICK MOUNTING BRACKETS



NOTE: IF YOUR MOUNT IS NOT LISTED CALL (833) 723-1843

PENGO AUGER MODELS DT-5, DT-15, DV-20 - 45MM

ORDER CODE SHIP WEIGHT
(LBS)

End of Stick Mount

Bobcat E85	662071
Bobcat 331 MINI EX]	661203
Bobcat Skid Steer	662007
Bobcat 709-8709	661609
Case 580M	661461
Case CX-160	661338
Case 210	662043
Case CX75	661867
Case CX-135	661254
CAT 308	661873
CAT 320 DV-30 / 40	661564
CAT 312	661340
CAT 329	661696
CAT 320/322-B	661331
CAT 308	662064
CAT 320C	661826
CAT 320 DV-30 / 40	661766
CAT 336	661686
CAT 420	661649
CAT 325	661629
CAT 420	661470
CAT 420	661405
CAT 315	661337
CAT 426C	661332
CAT 318	661303
CAT 330-B	661300
CAT 311	661236
CAT 325-B	661235
Daewoo S175V	661220
Doosan 225DX	661853
Eskridge 78 X 1.5	661590
Hitachi 160	662167
Hitachi EX230-LC-5	661334

MOUNTING BRACKETS FOR EXCAVATORS CONTINUED NEXT PAGE

PENGO AUGER MOUNTING KITS AND COMPONENTS

QUICK END OF STICK MOUNTING BRACKETS

PENGO AUGER MODELS DT-5, DT-15, DV-20 - 45MM	ORDER CODE	SHIP WEIGHT (LBS)
End of Stick Mount		
Hitachi 2450	661339	
John Deere 160	662167	
John Deere 410G	661390	
John Deere D-350 MINI EX	661221	
Komatsu PC-220	661222	
Komatsu PC-120 6E020	662131	
Komatsu PC35MR-1&2	661490	
Komatsu PC 60	661336	
Komatsu PC-138	661333	
Komatsu PC-78	661346	
Kubota KX040	661968	
New Holland EH-50 MINI	661287	
Sany 135	661906	
Takeuchi TB180FR	661574	
Volvo 220 EL	661909	
Volvo EC150	661566	
Wacker Neuson E125	662117	

AUGERS

SOIL CHART

Pengo has developed the below chart to help you decide which auger will be best suited for your project. The above triangles and color guide will be included with all products where applicable.

1	dirt; peat, organic silts, very loose sand, very soft, swamp, marsh
2	sand; loose, fine sand; loess and medium clay, flood plain soils, lake clay
3	silt; coarse sand to stiff clay, dense hydraulic fill, compacted fill, residual soils
4	clay; stiff to very stiff clay, glacial till, hard-pan, marls
5	gravel; basalt, very hard silts and clay, weathered laminated rock
6	fracturable rock; caliche, coarse gravel and cobbles; frozen soil
7	non-fracturable rock; granite, basalt, massive limestone

AUGER BITS

LANDSCAPE AGGRESSOR® AUGER BITS



Pengo's® Landscape Aggressor® is the perfect tool for landscaping applications or where smaller prime movers are required. Shorten flight bodies offers substantial weight reduction and performance is enhanced with our double entry flight design. Paired with our TriFlow® 350 pilot, providing three drill points for longer wear, the Landscape Aggressor provides big performance in a small package.



LANDSCAPE AGGRESSOR® AUGERS	ORDER CODE	SHIP WEIGHT (LBS)
30" Landscape Aggressor Augers 2" Round		
6" x 30" (2 teeth) 2" round	138400	35
9" x 30" (4 teeth) 2" round	138405	42
12" x 30" (4 teeth) 2" round	138410	48
36" Landscape Aggressor Augers 2" Hex		
6" x 36" (2 teeth) 2" hex	243182	34
9" x 36" (4 teeth) 2" hex	243183	44
12" x 36" (4 teeth) 2" hex	243184	48
15" x 36" (5 teeth) 2" hex	243185	57
18" x 36" (6 teeth) 2" hex	243186	67
36" Landscape Aggressor Augers 2.56" Round		
6" x 36" (2 teeth) 2.56" round	243187	33
9" x 36" (4 teeth) 2.56" round	243188	43
12" x 36" (4 teeth) 2.56" round	243189	47
15" x 36" (5 teeth) 2.56" round	243190	56
18" x 36" (6 teeth) 2.56" round	243191	66
48" Landscape Aggressor Augers 2" Round		
6" x 48" (2 teeth) 2" round	138010	50
9" x 48" (4 teeth) 2" round	138011	58
12" x 48" (4 teeth) 2" round	138012	68
15" x 48" (5 teeth) 2" round	138013	78
18" x 48" (6 teeth) 2" round	138014	85

AUGERS

AUGER BITS

AGGRESSOR® AUGER BITS



Pengo's® Aggressor® Auger is the standard in which all others are measured, a professional grade tool designed for daily and constant use. The patented Tri-Flow pilot provides unmatched auger stability as well as up to 50% longer wear over conventional pilot bits. Double flight technology provides maximum spoil removal and the 5/16" flight thickness provides the long term durability demanded for daily use.



AGGRESSOR® AUGERS	ORDER CODE	SHIP WEIGHT (LBS)
36" Aggressor Augers 2" Hex		
6" x 36" (2 teeth) 2" hex	236011	39
9" x 36" (4 teeth) 2" hex	236012	55
12" x 36" (4 teeth) 2" hex	236013	68
15" x 36" (5 teeth) 2" hex	236014	73
18" x 36" (6 teeth) 2" hex	236015	70
36" Aggressor Augers 2.56" Round		
6" x 36" (2 teeth) 2.56" round	236016	37
9" x 36" (4 teeth) 2.56" round	236017	54
12" x 36" (4 teeth) 2.56" round	236018	66
15" x 36" (5 teeth) 2.56" round	236019	72
18" x 36" (6 teeth) 2.56" round	236020	69
49" Aggressor Augers 2" Hex		
6" x 49" (2 teeth) 2" hex	PNG104152	54
9" x 49" (4 teeth) 2" hex	PNG104153	78
49" Aggressor Augers 2.56" Round		
6" x 49" (2 teeth) 2.56" round	PNG104168	54
9" x 49" (4 teeth) 2.56" round	PNG104169	78

AGGRESSOR AUGERS CONTINUED NEXT PAGE

AUGER BITS

AGGRESSOR® AUGER BIT CONT.

AGGRESSOR® AUGERS	ORDER CODE	SHIP WEIGHT (LBS)
51" Aggressor Augers 2" Hex		
12" x 51" (4 teeth) 2" hex	PNG104154	114
15" x 51" (5 teeth) 2" hex	PNG104155	117
18" x 51" (6 teeth) 2" hex	PNG104156	145
24" x 51" (8 teeth) 2" hex	PNG104157	210
30" x 51" (10 teeth) 2" hex	PNG104158	225
36" x 51" (12 teeth) 2" hex	PNG104159	295
51" Aggressor Augers 2.56" Round		
12" x 51" (4 teeth) 2.56" round	PNG104170	114 lbs
15" x 51" (5 teeth) 2.56" round	PNG104171	117 lbs
18" x 51" (6 teeth) 2.56" round	PNG104172	145 lbs
24" x 51" (8 teeth) 2.56" round	PNG104173	210 lbs
30" x 51" (10 teeth) 2.56" round	PNG104174	225 lbs
36" x 51" 12 teeth) 2.56" round	104175	295 lbs

AGGRESSOR® TREE AUGER BITS

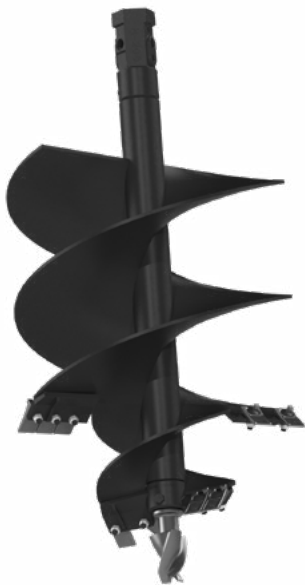

Pengo's® Aggressor® tree auger is a more robust version of our Landscape Aggressor Tree Auger and made specifically for high-duty cycle applications. Offering the same two-stage design that produces a tailored fit for the root ball, and the ability to change the pilot and teeth to accommodate light rock and permafrost soil conditions.



AGGRESSOR® TREE AUGERS	ORDER CODE	SHIP WEIGHT (LBS)
51" Aggressor Tree Augers 2" Hex		
9"/18" x 51" (8 teeth) 2" hex	135554	155
12"/24" x 51" (9 teeth) 2" hex	135555	160
15"/30" x 51" (11 teeth) 2" hex	135556	255
18"/36" x 51" (13 teeth) 2" hex	135557	290

AUGERS

AUGER BITS

TRIMAX® AUGER BITS



Pengo's® TriMax® auger is designed to handle your most challenging applications across a variety of drilling conditions. Available in both single and double flight configurations, the TriMax features our TriFlow® Pilot, which provides unmatched stability and wear characteristics. Combined with our Fas-N-Lok® teeth and cast head with compound angles; dirt, sand, silt or gravel are no match for the TriMax.



TRIMAX® AUGERS	ORDER CODE	SHIP WEIGHT (LBS)
36" Trimax Augers 2" Hex		
6" x 36" (2 teeth) 2" hex	243192	43
9" x 36" (4 teeth) 2" hex	243193	51
12" x 36" (4 teeth) 2" hex	243194	64
16" x 36" (6 teeth) 2" hex	243195	85
18" x 36" (6 teeth) 2" hex	243196	95
24" x 36" (8 teeth) 2" hex	243197	98
30" x 36" (10 teeth) 2" hex	243198	133
36" x 36" (12 teeth) 2" hex	243199	171
36" Trimax Augers 2.56" Round		
6" x 36" (2 teeth) 2.56" round	243200	42 lbs
9" x 36" (4 teeth) 2.56" round	243201	50 lbs
12" x 36" (4 teeth) 2.56" round	243202	63 lbs
16" x 36" (6 teeth) 2.56" round	243203	84 lbs
18" x 36" (6 teeth) 2.56" round	243204	94 lbs
24" x 36" (8 teeth) 2.56" round	243205	97 lbs
30" x 36" (10 teeth) 2.56" round	243206	132 lbs
36" x 36" (12 teeth) 2.56" round	243207	170 lbs

TRIMAX AUGERS CONTINUED NEXT PAGE

AUGER BITS

TRIMAX[®] AUGER BIT CONT.

TRIMAX [®] AUGERS	ORDER CODE	SHIP WEIGHT (LBS)
48" Trimax Augers 2" Hex		
6" x 48" (2 teeth) 2" hex	104091	62
9" x 48" (4 teeth) 2" hex	104093	78
12" x 48" (4 teeth) 2" hex	104095	106
16" x 48" (6 teeth) 2" hex	104097	100
18" x 48" (6 teeth) 2" hex	104098	124
24" x 48" (8 teeth) 2" hex	104100	166
30" x 48" (10 teeth) 2" hex	104101	207
36" x 48" (12 teeth) 2" hex	104102	270
48" x 48" (18 teeth) 2" hex	104104	375
48" Trimax Augers 2.5" Hex		
6" x 48" (2 teeth) 2.5" hex	243230	77
9" x 48" (4 teeth) 2.5" hex	243231	91
12" x 48" (4 teeth) 2.5" hex	243232	95
16" x 48" (6 teeth) 2.5" hex	243233	136
18" x 48" (6 teeth) 2.5" hex	243234	187
24" x 48" (8 teeth) 2.5" hex	243235	171
30" x 48" (10 teeth) 2.5" hex	243236	228
36" x 48" (12 teeth) 2.5" hex	243237	269
48" Trimax Augers 2.56" Round		
6" x 48" (2 teeth) 2.56" round	104108	61
9" x 48" (4 teeth) 2.56" round	104110	77
12" x 48" (4 teeth) 2.56" round	104112	105
16" x 48" (6 teeth) 2.56" round	104114	99
18" x 48" (6 teeth) 2.56" round	104115	123
24" x 48" (8 teeth) 2.56" round	104117	165
30" x 48" (10 teeth) 2.56" round	104118	206
36" x 48" (12 teeth) 2.56" round	104119	269

Single flight Trimax models available. Speak to your local representative for more information.

AUGERS

AUGER BITS

SEVERE ROCK RIPPER® AUGER BITS



Pengo's® Severe Rock Ripper® (SRR) is specifically designed to handle the most difficult rock applications. Featuring our Rock Ripper® Pilot, ½" thick hard faced flighting, and carbide conical teeth; the SRR is the most robust tool in the GP line-up. Our SRR can also be equipped with our Strata series of teeth, which provides drilling grade carbide and maximizes both performance and drilling efficiencies



SEVERE ROCK RIPPER® AUGERS	ORDER CODE	SHIP WEIGHT (LBS)
48" Severe Rock Ripper Augers 2" Hex		
6" x 48" (8 teeth) 2" hex	137950	80
9" x 48" (10 teeth) 2" hex	137951	108
12" x 48" (12 teeth) 2" hex	137952	130
16" x 48" (15 teeth) 2" hex	137953	170
18" x 48" (16 teeth) 2" hex	137954	192
24" x 48" (20 teeth) 2" hex	137956	285
30" x 48" (24 teeth) 2" hex	137957	345
36" x 48" (26 teeth) 2" hex	137958	415

The SRR Auger comes standard with the S-RL08 conical teeth.
 Replace with SR-76SW Strata® conical teeth for increased performance and life-cycle.

AUGER TEETH

40/50 AUGER TEETH

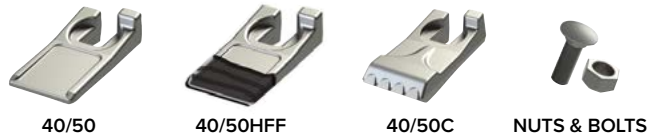

40/50 AUGER TEETH	COMPATABILITY	SOIL	ORDER CODE	SHIP WEIGHT (LBS)
40/50	Aggressor		134501	.5
40/50HFF	Aggressor		134802	.5
40/50C	Aggressor		134519	.65
Carriage Bolt	-	-	1872	-
Hex Nut Lock	-	-	1841	-

FAS-N-LOK AUGER TEETH

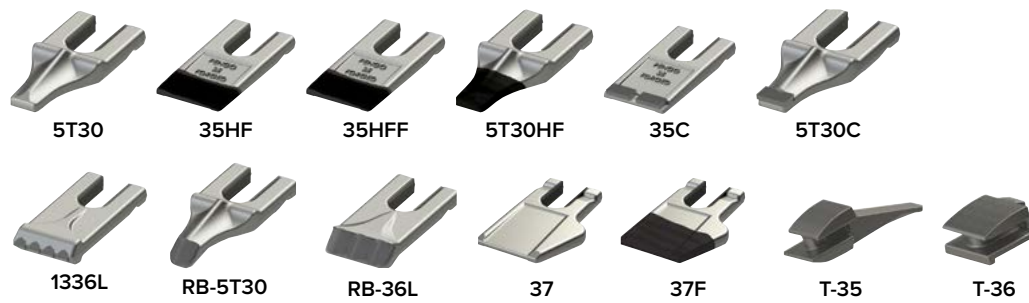

40/50 AUGER TEETH	COMPATABILITY	SOIL	ORDER CODE	SHIP WEIGHT (LBS)
35	Trimax		133835	.4
5T30	Trimax		140029	.4
37	Trimax		140027	.5
37F	Trimax		140010	.6
35 HF	Trimax		140008	.6
35 HFF	Trimax		140009	.6
5T30 HF	Trimax		140014	.4
35 C	Trimax		140007	.4
5T30 C	Trimax		140012	.4
1336L	Trimax		140016	.6
RB-5T30	Trimax		140013	.4
RB-36L	Trimax		140021	.6
T-35 Holder	-	-	171221	1
T-36 Holder	-	-	171231	1

AUGERS

AUGER TEETH

CONICAL AUGER TEETH

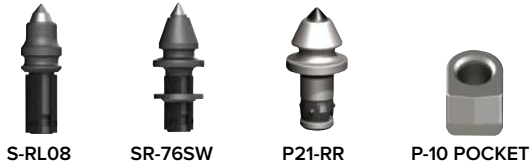

CONICAL AUGER TEETH	COMPATABILITY	SOIL	ORDER CODE	SHIP WEIGHT (LBS)
S-RL08	Severe Rock Ripper		PNG990021	.5
SR-76SW	Severe Rock Ripper		780001	.5
P21-RR	BoRH		137990	.65
P-10	Severe Rock Ripper	-	PNG990043	-

PILOT BITS



PILOT BITS	COMPATABILITY	SOIL	ORDER CODE	SHIP WEIGHT (LBS)
TF-350	Aggressor / Trimax		135088	5
TF-350HF	Aggressor / Trimax		135089	5.5
TF-350CXC	Aggressor / Trimax		135091	5.8
TF-350HFTC	Aggressor / Trimax		135092	5.5
TF-350C	Aggressor / Trimax		135090	5.5
RRP 1.75 SQ	Severe Rock Ripper		137208	15
3.5" Hex Bolt 6" - 9" Dia.	-	-	1098	-
4" Hex Bolt 12"+ Dia.	-	-	1100	-
Hex Nut Lock	-	-	1841	-

AUGERS BORH AND EXTENSIONS

BORH® KITS FOR AGGRESSOR AUGERS

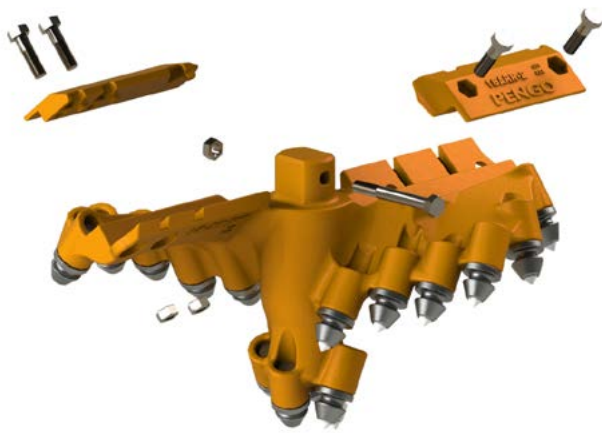

Pengo's patented BoRH® (Bolt on Rock Head) provides the ultimate solution for all your drilling applications. Designed to convert a standard Aggressor Dirt Auger into a rock auger, the BoRH eliminates the need for an additional and dedicated Rock Auger. The BoRH kit contains our boring head, pilot bit, wear caps, bullet-style carbide teeth and all hardware needed to complete the installation. Featuring innovative wear caps and enlarged shoulders on the teeth for increased wear, the BoRH system provides the ultimate solution across a wide variety of soil conditions.



BoRH KITS	ORDER CODE	SHIP WEIGHT (LBS)
6" Diameter BoRH (8 teeth)	137991	24
9" Diameter BoRH (10 teeth)	137992	36
12" Diameter BoRH (12 teeth)	137993	43
15" Diameter BoRH (15 teeth)	137994	47
18" Diameter BoRH (18 teeth)	137995	56
24" Diameter BoRH (24 teeth)	137996	79

EXTENSIONS

AUGER EXTENSIONS	ORDER CODE	SHIP WEIGHT (LBS)
Telescoping Extensions 2" Hex		
12" Length, 2" hex, (12" min length, 12" max length)	557142	22
24" Length, 2" hex, (12" min length, 24" max length, 12" hole spacing)	557143	34
36" Length, 2" hex (12" min length, 36" max length, 12" hole spacing)	557144	46
48" Length, 2" hex (12" min length, 48" max length, 12" hole spacing)	557145	58
60" Length, 2" hex (12" min length, 60" max length, 12" hole spacing)	557146	69
72" Length, 2" hex (12" min length, 72" max length, 12" hole spacing)	557147	82
Fixed Extensions 2" Round		
12" Length, 2" round	557176	20
24" Length, 2" round	557178	31
36" Length, 2" round	557174	40
Fixed Extensions 2.56" Round		
12" Length, 2.56" round	134203	20
24" Length, 2.56" round	134204	31
36" Length, 2.56" round	134205	40
48" Length, 2.56" round	134206	50
60" Length, 2.56" round	134207	61



AUGERS

AUGER HUBS, ADAPTERS, AND INSTALL TOOLS

HUBS

HUBS	ORDER CODE	SHIP WEIGHT (LBS)
Replacement Hubs		
2" Round Case	154080	5.2
2 9/16" Universal	154115	9.5
2" Hex Universal	154121	10.5
Hub Adapters		
2" Hex Female x 2 9/16" Round Male	134211	20
2" Hex Female x 2" Round Male	557156	14
2 1/2" Hex Female x 2" Hex Male	132419	30
2 1/4" Hex Female x 2" Hex Male	557159	20
2" Round Female x 2" Hex Male	132804	13
2" Round Female x 2 9/16" Round Male	134210	15
2 9/16" Round Female x 2 1/2" Hex Male	133906	21
2 9/16" Round Female x 2" Round Male	132068	13
2 9/16" Round Female x 2" Square Male	557155	19
2 9/16" Round Female x 2" Hex Male	557153	18



INSTALLATION & REMOVAL TOOLS



Soft Hammer



Drift Punch



C30 Puller



C123 Puller

INSTALLATION & REMOVAL TOOLS	COMPATABILITY	ORDER CODE	SHIP WEIGHT (LBS)
Soft Hammer	-	137737	3.5
Drift Punch	-	137750	1
C30 Puller	SR-76SW Strata Tooth	134090	3
C123 Puller	S-RL08 Teeth	134091	3

PENGO AUGER BITS

EXCAVATOR AUGERS - QUICK CHANGE

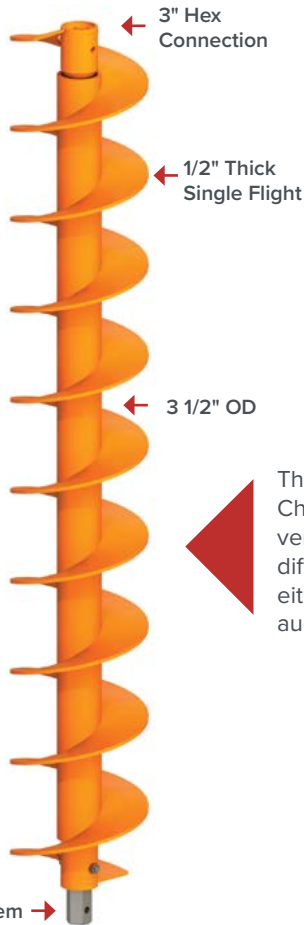

Pengo's Excavator Quick Change system is the perfect solution for turning your excavator into a dedicated drilling machine. Regardless of excavator brand or size our quick change system provides maximum flexibility and customization for a tailored made installation. Each system is a total package designed to match your excavator specifications. Featuring Revolution hydraulic drive heads, your choice between end of stick or quick connect mounting systems, multiple length flight bodies, and (3) separate drill head options, you can drill effectively in all soil conditions, from dirt to rock, both fracturable and non-fracturable

The Excavator Quick Change allows the versatility to use three different heads with either a 5', 10' or 20' auger flight section.



3" Hex Stem →

AVAILABLE OPTIONS:

1. Standard Dirt

TF-1000 Pilot,
2070Band
2072 Fas-N-Lok®
Teeth

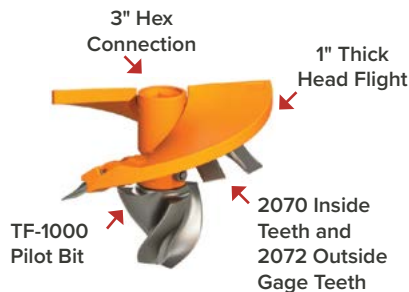

2. Step Rock

P-6000 Pilot
and
604C Drag
Style Tooth



3. Rock Option

C31-HD Pilot
and
SR-100 STRATA®
Conical Teeth



QUICK CHANGE AUGERS CONTINUED NEXT PAGE

AUGERS

EXCAVATOR AUGERS - QUICK CHANGE CONT.

FLIGHT SECTIONS

	ORDER CODE	SHIP WEIGHT (LBS)
5' Section 3" Hex		
16" x 5', 3" hex	165442	275
18" x 5', 3" hex	165443	335
20" x 5', 3" hex	165444	415
24" x 5', 3" hex	165445	470
30" x 5', 3" hex	165446	480
36" x 5', 3" hex	165447	610
42" x 5', 3" hex	165448	760
48" x 5', 3" hex	165449	935
10' Section 3" Hex		
16" x 10', 3" hex	165450	490
18" x 10', 3" hex	165452	570
20" x 10', 3" hex	165454	660
24" x 10', 3" hex	165456	730
30" x 10', 3" hex	165458	914
36" x 10', 3" hex	165460	1170
42" x 10', 3" hex	165462	1260
48" x 10', 3" hex	165464	1325

PIN ON HEAD ASSEMBLIES

	ORDER CODE	SHIP WEIGHT (LBS)
Step Rock Heads - P-6000 Pilot Bit and 604C Drag Style Tooth		
16" diameter, 8 teeth	165490	
18" diameter, 9 teeth	165492	
20" diameter, 10 teeth	165494	
24" diameter, 12 teeth	165496	123
30" diameter, 15 teeth	165498	
36" diameter, 18 teeth	165500	
42" diameter, 21 teeth	165502	
48" diameter, 24 teeth	165504	
Rock Heads - C31HD-8.5 Pilot (12"-30"), B47-10 Pilot (36"-54"), STRATA SR-100 Teeth		
16" diameter, 12 teeth	165510	165
18" diameter, 13 teeth	165512	185
20" diameter, 15 teeth	165514	210
24" diameter, 16 teeth	165516	265
30" diameter, 21 teeth	165518	276
36" diameter, 24 teeth	165520	320
42" diameter, 28 teeth	165522	336
48" diameter, 32 teeth	165524	346

PIN ON HEAD ASSEMBLIES CONTINUED NEXT PAGE

EXCAVATOR AUGERS - QUICK CHANGE CONT.

PIN ON HEAD ASSEMBLIES

	ORDER CODE	SHIP WEIGHT (LBS)
Carbide Heads - TF-1000 Pilot Bit, 2078 and 2079 Fas-N-Lok Gage Teeth		
16" diameter, 2 (2079) teeth	165471	135
18" diameter, 3 (2079) teeth	165473	155
20" diameter, 4 (2079) teeth	165475	167
24" diameter, 5 (2079) teeth	165477	185
30" diameter, 6 (2079) teeth	165479	185
36" diameter, 2 (2078) teeth, 8 (2079) teeth	165481	340
42" diameter, 2 (2078) teeth, 10 (2079) teeth	165483	355
48" diameter, 2 (2078) teeth, 10 (2079) teeth	165485	403
Dirt Heads - TF-1000 Pilot Bit, 2070 and 2072 Fas-N-Lok Dirt Teeth		
16" diameter, 2 (2072) teeth	165470	136
18" diameter, 1 (2070) teeth, 2 (2072) teeth	165472	155
20" diameter, 2 (2070) teeth, 2 (2072) teeth	165474	183
24" diameter, 3 (2070) teeth, 2 (2072) teeth	165476	206
30" diameter, 4 (2070) teeth, 2 (2072) teeth	165478	249
36" diameter, 6 (2070) teeth, 2 (2072) teeth	165480	333
42" diameter, 8 (2070) teeth, 2 (2072) teeth	165482	376
48" diameter, 10 (2070) teeth, 2 (2072) teeth	165484	426

ACCESSORIES	SOIL	ORDER CODE	SHIP WEIGHT (LBS)
Pin Auger [DP-2] Drive Pin	-	157779	0.1
Pin Auger [DP-3] Drive Pin	-	157780	0.1
Pin Auger [DP-4] Drive Pin	-	157781	0.3
Pin Auger [DP-5] Drive Pin	-	157782	0.5
Tooth [2070] Dirt Fas-N-Lok		140002	2
Tooth [2072] Dirt Gage Fas-N-Lok		140000	2.3
Tooth [2077] Carbide Fas-N-Lok		140003	.7
Tooth [2078] Carbide Gage Fas-N-Lok		140004	1
Tooth [2079] Carbide Fas-N-Lok		140001	3.3
Tooth [604-C] Carbide Rock		140065	1
Tooth [SR-100]		780002	1.1
Pilot Bit [TF-1000HFTC] 2-1/2 SQ		137354	46
Pilot Bit [P-6000] 4 3/4 Dia 4 Step		151275	8
Pilot Bit [C31HD-8.5] 2.5 SQ Pin/Washer		135913	30
Pilot Adapter [2.5" SQ x 6"OD] Cast	-	151598	

AUGERS

EXCAVATOR AUGERS - S-400 OR S-130MM CONNECTION

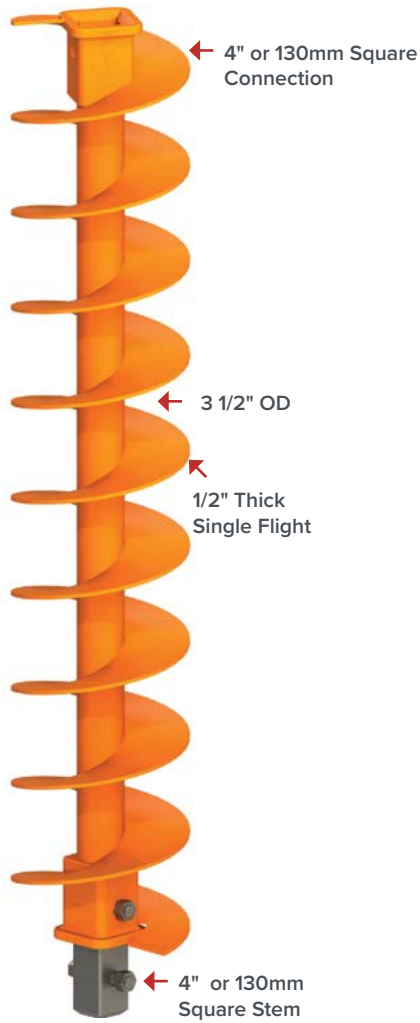

Pengo continues to provide solutions for our customers. With the introduction of the Revolution Series Drilling drives came the need for a complete excavator auger system. This system is available for both rock and dirt drilling and come in five foot sections. Each five foot section attaches to a five foot or ten foot flight section.



AVAILABLE LEAD SECTIONS:

DIRT



ROCK

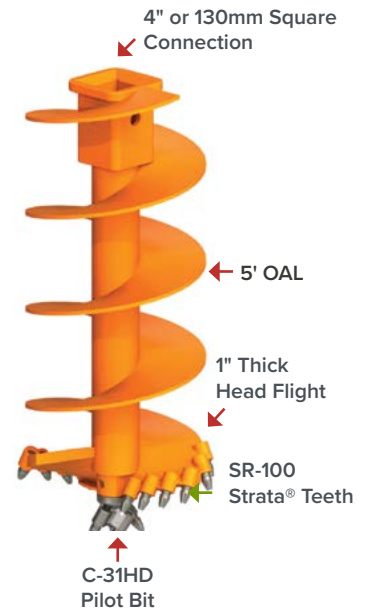

EXCAVATOR AUGERS CONTINUED NEXT PAGE

EXCAVATOR AUGERS - S-400 OR S-130MM CONNECTION CONT.

FLIGHT SECTIONS

	ORDER CODE	SHIP WEIGHT (LBS)
5' Section 4" Square		
16" x 5', 4" square	165759	
18" x 5', 4" square	165762	
20" x 5', 4" square	165763	
24" x 5', 4" square	165764	
30" x 5', 4" square	165765	
36" x 5', 4" square	165766	
42" x 5', 4" square	165767	
48" x 5', 4" square	165768	
10' Section 4" Square		
16" x 10', 4" square	165712	
18" x 10', 4" square	165713	
20" x 10', 4" square	165714	
24" x 10', 4" square	165715	
30" x 10', 4" square	165592	
36" x 10', 4" square	165716	
42" x 10', 4" square	165717	
48" x 10', 4" square	165718	
5' Rock Lead Section for S-400 Connection - C31-HD 8.5 Pilot Bit, Strata SR-100 Conical Teeth		
16" x 5', 4" square, 12 teeth	165700	
18" x 5', 4" square, 13 teeth	165701	
20" x 5', 4" square, 15 teeth	165702	
24" x 5', 4" square, 16 teeth	165584	
30" x 5', 4" square, 21 teeth	165587	
36" x 5', 4" square, 24 teeth	165703	
42" x 5', 4" square, 28 teeth	165704	
48" x 5', 4" square, 32 teeth	165705	
5' Dirt Lead Section for S-400 Connection - TF-1000 Pilot Bit, 2070 and 2072 Fas-N-Lok Dirt Teeth		
16" x 5', 4" square, 2 (2072) teeth	165706	
18" x 5', 4" square, 1 (2070), 2 (2072) teeth	165707	
20" x 5', 4" square, 2 (2070), 2 (2072) teeth	165708	
24" x 5', 4" square, 3 (2070), 2 (2072) teeth	165585	
30" x 5', 4" square, 4 (2070), 2 (2072) teeth	165588	
36" x 5', 4" square, 6 (2070), 2 (2072) teeth	165709	
42" x 5', 4" square, 8 (2070), 2 (2072) teeth	165710	
48" x 5', 4" square, 10 (2070), 2 (2072) teeth	165711	

EXCAVATOR FLIGHT SECTIONS CONTINUED NEXT PAGE

AUGERS

EXCAVATOR AUGERS - S-400 OR S-130MM CONNECTION CONT.

FLIGHT SECTIONS

	ORDER CODE	SHIP WEIGHT (LBS)
5' Section 130mm Square		
16" x 5', 130mm square	165769	
18" x 5', 130mm square	165770	
20" x 5', 130mm square	165771	
24" x 5', 130mm square	165772	
30" x 5', 130mm square	165773	
36" x 5', 130mm square	165774	
42" x 5', 130mm square	165775	
48" x 5', 130mm square	165776	
10' Section 130mm Square		
16" x 10', 130mm square	165743	
18" x 10', 130mm square	165744	
20" x 10', 130mm square	165745	
24" x 10', 130mm square	165746	
30" x 10', 130mm square	165747	
36" x 10', 130mm square	165748	
42" x 10', 130mm square	165749	
48" x 10', 130mm square	165750	
5' Rock Lead Section for S-130mm Connection - C31-HD 8.5 Pilot Bit, Strata SR-100 Conical Teeth		
16" x 5', 130mm square, 12 teeth	165727	
18" x 5', 130mm square, 13 teeth	165728	
20" x 5', 130mm square, 15 teeth	165729	
24" x 5', 130mm square, 16 teeth	165730	
30" x 5', 130mm square, 21 teeth	165731	
36" x 5', 130mm square, 24 teeth	165732	
42" x 5', 130mm square, 28 teeth	165733	
48" x 5', 130mm square, 32 teeth	165734	
5' Dirt Lead Section for S-130mm Connection - TF-1000 Pilot Bit, 2070 and 2072 Fas-N-Lok Dirt Teeth		
16" x 5', 130mm square, 2 (2072) teeth	165735	
18" x 5', 130mm square, 1 (2070), 2 (2072) teeth	165736	
20" x 5', 130mm square, 2 (2070), 2 (2072) teeth	165737	
24" x 5', 130mm square, 3 (2070), 2 (2072) teeth	165738	
30" x 5', 130mm square, 4 (2070), 2 (2072) teeth	165739	
36" x 5', 130mm square, 6 (2070), 2 (2072) teeth	165740	
42" x 5', 130mm square, 8 (2070), 2 (2072) teeth	165741	
48" x 5', 130mm square, 10 (2070), 2 (2072) teeth	165742	
EXCAVATOR AUGERS ACCESSORIES CONTINUED NEXT PAGE		

EXCAVATOR AUGERS - S-400 OR S-130MM CONNECTION CONT.

ACCESSORIES	SOIL	ORDER CODE	SHIP WEIGHT (LBS)
Tooth [2070] Dirt Fas-N-Lok		140002	2
Tooth [2072] Dirt Gage Fas-N-Lok		140000	2.3
Tooth [1656] Carbide Rock Fas-N-Lok		140005	.7
Tooth [1658] Carbide Gage Fas-N-Lok		140006	1
Tooth [2079] Carbide Fas-N-Lok		140001	3.3
Tooth [SR-100]		780002	1.1
Tooth [S31HD]		140065	1.1
Pilot Bit [TF-1000] 2-1/2 SQ		137348	46
Pilot Adapter [2.5" SQ x 6"OD] Cast	-	151598	
Pilot Bit [C31HD-8.5] 2.5 SQ Pin/Washer		135913	30
P30 Pocket	-	990001	.7
C30 Puller	-	134090	3
Soft Hammer	-	137737	3.5

BALE/HAY HANDLING



BALE TOOLS

BALE/HAY GRAPPLE BUCKET



- Single auxiliary hydraulic circuit
- Includes grapple with spill screen
- Optional bolt-on cutting edge

Specifications					
Model	Weight (approx)	Width	Height	Depth	Height
LAF2501	400 lbs	67.68"	56"	48"	85"

Carrier Specifications	
Lift Capacity	Operating Weight
<5,000 lbs.	<15,000 lbs.

BALE/HAY GRAPPLE BUCKET FOR COMPACT TRACTORS



INCLUDES: BUCKET, MOUNTING. AND GRAPPLE.
TO ORDER: SELECT ATTACHMENT, ANY OPTIONS.

BALE / HAY GRAPPLE BUCKET CHECK LOADER CAPACITY BEFORE ORDERING	ORDER CODE	SHIP WEIGHT (LBS)
72" OD Round Utility Bucket w/ Grapple Kit and Universal Hitch	124472	972
84" OD Round Utility Bucket w/ Grapple Kit and Universal Hitch	124474	1044
96" OD Round Utility Bucket w/ Grapple Kit and Universal Hitch	124476	1086
72" OD Round Utility Bucket w/ Grapple Kit and Euro Global Hitch	124513	972
84" OD Round Utility Bucket w/ Grapple Kit and Euro Global Hitch	124515	1044
96" OD Round Utility Bucket w/ Grapple Kit and Euro Global Hitch	124517	1086

BOLT-ON BALE GRAPPLE* HOSES AND QUICK COUPLER NOT INCLUDED	ORDER CODE	SHIP WEIGHT (LBS)
Bale Grapple	LAF2501-0000	400
Weld-On Rib Kit (required if purchasing Bolt-On Grapple)	LAF2502-0000	NA

*For adding to existing buckets

MOUNTING - ADDITIONAL COST MAY APPLY	ORDER CODE	SHIP WEIGHT (LBS)

Contact Customer Service at (833) 723-1843

OPTIONAL - REVERSIBLE CUTTING EDGE KIT INCLUDES BOE, GRADE 8 PLOW BOLTS, LOCK WASHERS & NUTS DRILLED FOR FFC BOLT-ON EDGE (HOLES SPACED 6" APART, CENTER TO CENTER)	ORDER CODE	SHIP WEIGHT (LBS)
For Bucket LAF2572 (7 holes, 11" spacing)	102236	123
For Bucket LAF2584 (9 holes, 10" spacing)	113978	143
For Bucket LAF2596 (9 holes, 10.82" spacing)	114197	163

For Optional Bolt-On Edge Drill Patterns (i.e. Case Hole Patterns) - Call (833) 723-1843

BALE/HAY GRAPPLE BUCKET - HEAVY-DUTY



BALE/HAY GRAPPLE BUCKET - HEAVY-DUTY FOR TRACTOR LOADERS/ BACKHOES



i INCLUDES: GRAPPLE BUCKET AND MOUNT.

	ORDER CODE	SHIP WEIGHT (LBS)
Cat IT / TH 1.75 cu yd	307150	2100
Cat IT/TH optional edge kit for 307150 1.75 cu yd, 12 holes	14611	225
JCB Q-fit	308403	2100
JCB (optional edge kit for above 308403)	11002	185
New Holland-Versattach	308403	2100

BALE/HAY GRAPPLE BUCKET - HEAVY-DUTY FOR WHEEL LOADERS



i INCLUDES: GRAPPLE BUCKET AND MOUNT.

	ORDER CODE	SHIP WEIGHT (LBS)
CAT IT/TH 1.75 cu yd	307150	2100
Cat IT/TH optional edge kit for 307150 1.75 cu yd, 12 holes	14611	225

BALE TOOLS

BALE CARRIAGE - DUAL LARGE SQUARE



- Designed to pick-up & transfer agriculture materials
- Excellent visibility through frame
- For round or square bale application
- Large heavy duty frame
- Includes tapered forged tines

BALE CARRIAGE - DUAL LARGE SQUARE FOR TELEHANDLERS



	ORDER CODE	SHIP WEIGHT (LBS)
CAT IT/TH	15892	975
JCB Q-fit	12393	975
New Holland-Versattach	12393	975

BALE CARRIAGE - DUAL LARGE SQUARE FOR TRACTOR LOADERS/BACKHOES



	ORDER CODE	SHIP WEIGHT (LBS)
JCB Q-fit	12393	975
CAT IT/TH	15892	975
New Holland - Versattach	12393	975

BALE CARRIAGE - DUAL LARGE SQUARE FOR WHEEL LOADERS



	ORDER CODE	SHIP WEIGHT (LBS)
CAT IT/TH	15892	975
John Deere 544J w/JRB 416MTG	13173	931

BALE HUGGER

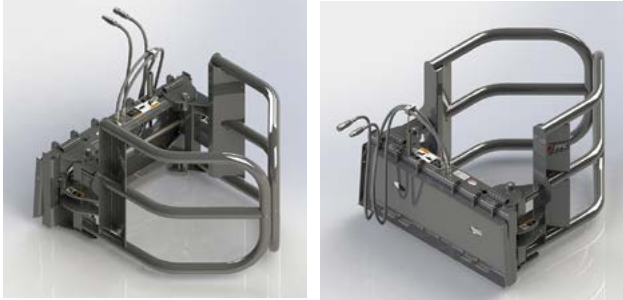

- Provides constant pressure that eliminates risk of dropped bales
- Ideal for 1,000 lb. silage bale, max. load of 2,400 lbs.
- Can lift, move and stack round or rectangular bales

Carrier Specifications	
Lift Capacity	Operating Weight
<10,000 lbs.	<32,000 lbs.

 **NOTE: All replacement hydraulic hoses and fittings must have a minimum rated working pressure of 4000 PSI.**

Specifications				
Model	Width Open	Height	Depth	Weight (approx)
LAF1960	89"	47"	54"	520 lbs

BALE HUGGER FOR SKID-STEER LOADERS/COMPACT TRACTORS



INCLUDES: BALE HUGGER AND UNIVERSAL MOUNTING. TO ORDER CHOOSE A BALE HUGGER AND MOUNTING.

BALE HUGGER CHECK LOADER CAPACITY BEFORE ORDERING	ORDER CODE	SHIP WEIGHT (LBS)
Bale Hugger (clamps loads from 28" to 80" wide)	LAF1960-0022	520

MOUNTING ADDITIONAL COST MAY APPLY	ORDER CODE	SHIP WEIGHT (LBS)
Contact Customer Service at (833) 723-1843		

BALE HUGGER - LARGE ROUND

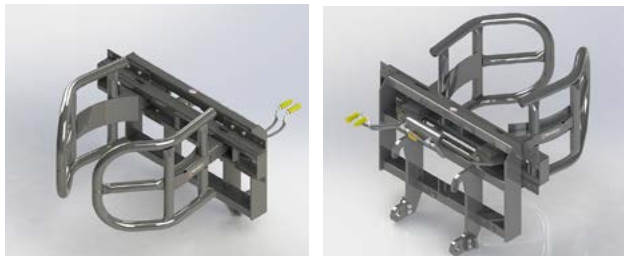

- 4 to 5 ft opening arms holds wrapped round bales
- Single cylinder allows arms to hug equally
- Fully assembled including hoses & couplers
- Designed with round tubing to prevent damage to wrapped bale coverings

BALE HUGGER - LARGE ROUND FOR EURO/GLOBAL MOUNTS



	ORDER CODE	SHIP WEIGHT (LBS)
Assembly 6 ft.	111776	835

BALE TOOLS

BALE SPEAR - CROSS BOLT DESIGN



- Designed to fit compact tractors up to 50 hp
- Picks up one large round bale up to 6' in diameter (see weight limits below)
- Available in single, dual, and triple spears

Bale Spear Specifications							
Model	Weight (approx)	Width OD	Height OD	Depth OD	Round Bale Capacity	Main Spear	Stabilizer Spear
17200-Single	145 lbs	45.25"	22.375"	50.5"	2000 lbs @ 24"	(1) 1.75" x 49"	(2) 1" x 19"
17212-Dual	155 lbs	45.25"	22.375"	50.5"	3000 lbs @ 24"	(2) 1.75" x 49"	NA
11910-Single	195 lbs	45.25"	22.375"	50.5"	3000 lbs @24"	(1) 2.1875" x 53"	(2) 1" x 19"
11920-Dual	235 lbs	45.25"	22.375"	50.5"	4000 lbs @24"	(2) 2.1875" x 53"	(1) 1" x 19"
17213-triple	230 lbs	45.25"	22.375"	50.5"	4000 lbs @ 24"	(3) 1.75" x 49"	NA
10712	150 lbs	45.25"	22.375"	50.5"	3000 lbs @ 24"	(1) 2.1875" x 53"	(2) 1" x 19"

BALE SPEAR - CROSS BOLT DESIGN FOR SKID-STEER LOADERS



BALE SPEAR - CHECK LOADER CAPACITY	ORDER CODE	SHIP WEIGHT (LBS)
Single Bale Spear (2000 lb. maximum bale size)	17200-0022	145
Dual Bale Spear (3000 lb. maximum bale size)	17212-0022	155
Single Heavy Duty Bale Spear (3000 lb. maximum bale size)	11910-0022	222
Dual Heavy Duty Bale Spear(4000 lb. maximum bale size)	11920-0022	240
Triple Spear (4000 lb. maximum bale size)	17213-0022	230
3 Point Hitch (3000 lb. maximum bale size)	10712-0052	145

BALE SPEAR - HEAVY DUTY FOR TRACTOR LOADER/BACKHOES AND WHEEL LOADERS



BALE SPEAR - CHECK LOADER CAPACITY	ORDER CODE	SHIP WEIGHT (LBS)
Single Heavy Duty Bale Spear - JRB 418 (3000 lb. maximum bale size)	118186	431
Single Heavy Duty Bale Spear - QCP7000 (3000 lb maximum bale size)	11910-0733	296
Single Heavy Duty Bale Spear - JD TLB QA/JRB E SERIES (3000 lb maximum bale size)	11910-0869	239
Single Heavy Duty Bale Spear - JRB 416 (3000 lb maximum bale size)	12828	399
Dual Heavy Duty Bale Spear - QCP7000 (4000 lb maximum bales size)	11920-0733	356
Dual Heavy Duty Bale Spear	11920-0934	475

REPLACEMENT TINES	ORDER CODE	SHIP WEIGHT (LBS)
Bale Spear, 53" x 55mm, Heavy Duty fits 11910, 11920, and 10712	07-10150	38
Bale Spear, 45mm x 1250mm, cross bolts fits 17200, 17212, 17213	116336	25

OPTIONAL REPLACEMENT PARTS	ORDER CODE	SHIP WEIGHT (LBS)
Small Spike (1" x 19")	13-52026	NA
Large Spike w/Nut (1-3/4" x 41")	07-10141	NA

BOOMS



BOOMS

BOOMS - LOADER



- Ideal for moving trees for transplanting
- Use to load and unload attachments, etc.
- Ideal for placing & removing concrete forms
- Adds 6.5 feet of reach to your loader
- Does not include chains or clevis
- Must be shipped with SSL Mounting

Carrier Specifications	
Lift Capacity	Operating Weight
<10,000 lbs.	<32,000 lbs.

Specifications						
Model	Weight (approx)	Width	Load Depth	Depth	Height	Reach
LAF2210	440 lbs	47"	25.1"	31"	73.2"	83.1"



NOTE: All replacement hydraulic hoses and fittings must have a minimum rated working pressure of 4000 PSI.

Maximum Loads That Can Be Safely Lifted



Vertical Mast
70% of operating load not to exceed 6,000 lbs



Max. Reach
30% of operating load not to exceed 6,000 lbs

BOOMS - LOADER FOR SKID-STEER LOADERS/COMPACT TRACTORS/TRACTOR LOADER BACKHOES/WHEEL LOADERS EQUIPPED WITH SSL UNIVERSAL MOUNTING



INCLUDES: LOADER BOOM AND UNIVERSAL SSL MOUNTING.

LOADER BOOM		ORDER CODE	SHIP WEIGHT (LBS)
CHECK LOADER CAPACITY BEFORE ORDERING			
Loader Boom		LAF2210-0022	440

MOUNTING		ORDER CODE	SHIP WEIGHT (LBS)
ADDITIONAL COST MAY APPLY			
Contact Customer Service at (833) 723-1843			

BOOMS - TREE (LIFTING ARMS)



- Fully welded square tube design
- Pintle hook with safety latch on front plate
- Quick attach mounting system for optimal safety & ease of operation
- Ideal for landscapers & nurseries

BOOMS - TREE FOR WHEEL LOADERS



	ORDER CODE	SHIP WEIGHT (LBS)
Cat 902/906/908 (8,000 design rating)	12609	560

BOOMS - TRUSS (ADJUSTABLE)



- Adjusts to 8', 11', & 13'
- Load ratings: 8' is 4,000 lbs, 11' is 3,000 lbs, & 13' is 2,000 lb
- Pintle hook with safety latch on front plate
- Excellent for all contractors

BOOMS - TRUSS (ADJUSTABLE) FOR TRACTOR LOADERS/BACKHOES



	ORDER CODE	SHIP WEIGHT (LBS)
Cat 416C/420D pin mount adjustable truss boom	12688	1175

BOOMS - TRUSS (ADJUSTABLE) FOR WHEEL LOADERS



	ORDER CODE	SHIP WEIGHT (LBS)
Cat IT38/IT62	12689	1210
Cat IT14/IT24/IT28	12397	1120
JCB 411/416 & Volvo L40-L120	12396	1120
JRB 416 QA	13225	1220
New Holland LW130-170 adj truss boom	12396	1120

BOOMS

BOOMS - TRUSS (ADJUSTABLE)



- Adjusts to 8', 11', & 13'
- Load ratings: 8' is 4,000 lbs, 11' is 3,000 lbs, & 13' is 2,000 lb
- Pintle hook with safety latch on front plate
- Excellent for all contractors

BOOMS - TRUSS (ADJUSTABLE) FOR TRACTOR LOADERS/BACKHOES



	ORDER CODE	SHIP WEIGHT (LBS)
Cat 416C/420D pin mount adjustable truss boom	12688	1175

BOOMS - TRUSS (ADJUSTABLE) FOR WHEEL LOADERS



	ORDER CODE	SHIP WEIGHT (LBS)
Cat IT38/IT62	12689	1210
Cat IT14/IT24/IT28	12397	1120
JCB 411/416 & Volvo L40-L120	12396	1120
JRB 416 QA	13225	1220
New Holland LW130-170 adj truss boom	12396	1120

BOOMS - TRUSS WITH QUICK ATTACH



- Fully welded square tube design
- Quick attach mounting system standard
- Pintle hook with safety latch on front plate

BOOMS - TRUSS WITH QUICK ATTACH FOR TRACTOR LOADERS/BACKHOES



12' TRUSS BOOMS W/QUICK ATTACH (2,000 LB. DESIGN RATING)	ORDER CODE	SHIP WEIGHT (LBS)
Cat IT/TH	11140	600

BOOMS - TRUSS WITH HYDRAULIC WINCH



- 4,000 lb design on 3' & 2,000 lb design on 12' models
- Includes 65' of 7/16" wire rope cable
- Tulsa winch with oil cooled brake & roller bearing swivel hook with latch

BOOMS - TRUSS WITH HYDRAULIC WINCH FOR WHEEL LOADERS



3' TRUSS BOOM W/HYDRAULIC WINCH (4,000 LB. DESIGN RATING)	ORDER CODE	SHIP WEIGHT (LBS)
Volvo L30-L35	12340	615

BRUSH CUTTERS



BRUSH CUTTERS

GROUND SHARK® BRUSH CUTTERS

STANDARD DUTY (SD)	HEAVY DUTY (HD)	HIGH PERFORMANCE (HP)	EXTREME DUTY (XD)
			
ROUTINE LAND MAINTENANCE	MORE AGGRESSIVE	MOST RANGE	MOST AGGRESSIVE
Cuts back grass overgrowth and heavy brush up to 4" in diameter. Low-profile design slips easily under fences. The perfect general purpose brush cutter for routine land maintenance.	For heavier brush and trees up to 7" in diameter. Includes carbide mulching teeth and a retractable front shield, allowing blades to fully engage with trees for deep, aggressive cuts.	Handles wider range of vegetation conditions including grass, brush and trees up to 10". Optimized blade carrier design with forged AR400 blades for fast startup and recovery time. Wide 84" cutting path offered for increased productivity. Includes retractable front shield and MulchPower feedback technology.	For very heavy brush and trees up to 10" in diameter. Heavier than the Heavy-Duty version by having; bigger blades, bigger deck, and double-pin blade retention. Includes carbide stump grinding teeth, retractable front shield and MulchPower feedback technology.
Grass, Shrubs, Small Trees	Grass, Shrubs, Medium Trees	Grass, Shrubs, Large Trees	Grass, Shrubs, Large Trees
			
Up to 4" Capacity	Up to 7" Capacity	Up to 10" Capacity	Up to 10" Capacity
15 - 40 GPM	20 - 34 GPM	30 - 40/45 GPM	30 - 45 GPM
1,120 - 1,405 LBS	1,605 - 1,800 LBS	1,780 - 2,260 LBS	2,008 - 2,267 LBS
 Optional	 Optional	 Technology Included	 Technology Included

BRUSH CUTTERS

FAMILY	MODEL	CUT WIDTH	CUT DIA	MIN CUT HT	WT LBS	FLOW GPM	MOTOR	MULCHPOWER GAUGE	HOSE WRAP	BI-DIRECTIONAL CUTTING
Standard Duty (SD)	GS60SD	60	4	2	1120	15-25	Gerotor	Optional		●
Standard Duty (SD)	GS72SD (A)	72	4	2	1280	15-25	Gerotor	Optional		●
Standard Duty (SD)	GS72SD (B)	72	4	2	1280	26-32	Gerotor	Optional		●
Standard Duty (SD)	GS72SD (C)	72	4	2	1320	33-40	Gerotor	Optional		●
Standard Duty (SD)	GS78SD (A)	78	4	2	1365	15-25	Gerotor	Optional		●
Standard Duty (SD)	GS78SD (B)	78	4	2	1365	26-32	Gerotor	Optional		●
Standard Duty (SD)	GS78SD (C)	78	4	2	1405	33-40	Gerotor	Optional		●
Heavy Duty (HD)	GS66HD	66	7	2.5*	1605	20-34	Gerotor	Optional	●	●
Heavy Duty (HD)	GS72HD	72	7	2.5*	1800	20-34	Gerotor	Optional	●	●
High Performance (HP)	GS72HP	72	10	2.5*	1865	30-45	Radial Piston	●	●	
High Performance (HP)	GS84HP	84	10	2.5*	2178	30-40	Radial Piston	●	●	
Extreme Duty (XD)	GS72XD	72	10	3.25*	2008	30-45	Radial Piston	●	●	
Extreme Duty (XD)	GS78XD	78	10	3.25*	2267	30-45	Radial Piston	●	●	

*Angled Front Allows Cut to Ground Level

STANDARD DUTY (SD)

ROUTINE LAND MAINTENANCE

Cuts back grass overgrowth and heavy brush up to 4" in diameter. Low-profile design slips easily under fences. The perfect general purpose brush cutter for routine land maintenance.

HEAVY DUTY (HD)

MORE AGGRESSIVE

For heavier brush and trees up to 7" in diameter. Includes carbide mulching teeth and a patented retractable front shield, allowing blades to fully engage with trees for deep, aggressive cuts.

HIGH PERFORMANCE (HP)

MOST RANGE

Handles wider range of vegetation conditions including grass, brush and trees up to 10". Optimized blade carrier design with forged AR400 blades for fast startup and recovery time. Wide 84" cutting path offered for increased productivity. Includes patented retractable front shield and MulchPower™ feedback technology.

EXTREME DUTY (XD)

MOST AGGRESSIVE

For very heavy brush and trees up to 10" in diameter. Heavier than the Heavy-Duty version by having; bigger blades, bigger deck, and double-pin blade retention. Includes carbide stump grinding teeth, patented retractable front shield and MulchPower™ feedback technology.

FAMILY	MODEL	BLADE QTY & TYPE	HEX SHANK BOLT	PUCK BLADE MOUNT	CARBIDE TEETH QTY	DECK THICKNESS	PUSH BAR	SERRATED EDGES - BAR & DECK	DUAL WHEEL KIT	RETRACTABLE SHIELD
Standard Duty (SD)	GS60SD	3 - Bi-Directional				0.25			Opt	
Standard Duty (SD)	GS72SD (A)	3 - Bi-Directional				0.25			Opt	
Standard Duty (SD)	GS72SD (B)	3 - Bi-Directional				0.25			Opt	
Standard Duty (SD)	GS72SD (C)	3 - Bi-Directional				0.25			Opt	
Standard Duty (SD)	GS78SD (A)	3 - Bi-Directional				0.25			Opt	
Standard Duty (SD)	GS78SD (B)	3 - Bi-Directional				0.25			Opt	
Standard Duty (SD)	GS78SD (C)	3 - Bi-Directional				0.25			Opt	
Heavy Duty (HD)	GS66HD	3 - Bi-Directional	●		24	0.25	●	●		●
Heavy Duty (HD)	GS72HD	4 - Bi-Directional	●		48	0.25	●	●		●
High Performance (HP)	GS72HP	3 - Uni-Directional Single Edge	●			0.25	●	●		●
High Performance (HP)	GS84HP	3 - Uni-Directional Single Edge	●			0.31	●	●		●
Extreme Duty (XD)	GS72XD	4 - Uni-Directional Double Bevel Edge / Flippable		●	18	0.25	●	●		●
Extreme Duty (XD)	GS78XD	4 - Uni-Directional Double Bevel Edge / Flippable		●	22	0.25	●	●		●

FEATURES - ALL MODELS

- Route Hoses Either Side
- Deck Steps on Both Sides
- Blade Accessible Cover
- Bolt-On Replaceable Skid Shoes
- Shielded Motor & Valve Assembly
- Leading Edge Radius Guide
- High-Strength Chain Guard
- Safety Lift Limit Chain
- Braking System
- Audible Braking Signal
- Hydraulic Couplers Included
- Direct Drive
- Tie Down & Lift Points
- High Grade 50 KPSI Yield Deck Steel

BRUSH CUTTERS

GROUND SHARK™ STANDARD DUTY

BRUSH CUTTERS



- Dual pressure reliefs on the hydraulic motor allow for bi-directional operation protect against pressure spikes that could damage the drive system.
- Bi-directional forged steel blades (3) allow operator to cut in both directions extending operational life and reducing maintenance cost by cutting heavier brush in one-direction and grass or smaller vegetation in the other.
- The Ground Shark line of brush cutters include special hydraulic valving to shut the cutter head down quickly and safely. There is a distinct audible sound during the shutdown which will indicate to the operator that the blades are coming to a stop.
- Direct drive motor for efficient performance.
- Deck steps on both sides to facilitate different carriers with entry on left or right side. Hose routing can also be configured on either side.
- Deck Leading Edge Radius Guide enables smoother material glide path.
- .25 thick steel deck design.
- Bolt-on replaceable skid shoes.
- An optional MulchPower™ gauge is visible to the operator and helps prevent excessive stalling and overheating.
- Optional dual wheel kits are available that mount to the underside of the front deck to keep the blades off the ground and prevent scalping.

	GS60SD	GS72SD (A)	GS72SD (B)	GS72SD (C)	GS78SD (A)	GS78SD (B)	GS78SD (C)
ORDER CODE	30360A-0022	30372A-0022*	30372B-0022*	30372C-0022*	30378A-0022*	30378B-0022*	30378C-0022*
COUPLER SIZE	1/2 IN.	1/2 IN.	1/2 IN.	1/2 IN.	1/2 IN.	1/2 IN.	1/2 IN.
OVERALL HEIGHT	24 IN.	24 IN.	24 IN.	27 IN.	24 IN.	24 IN.	27 IN.
OVERALL WIDTH	64 IN.	76 IN.	76 IN.	76 IN.	82 IN.	82 IN.	82 IN.
OVERALL LENGTH	76 IN.	88 IN.	88 IN.	88 IN.	9 IN.	94 IN.	94 IN.
CUTTING WIDTH	60 IN.	72 IN.	72 IN.	72 IN.	78 IN.	78 IN.	78 IN.
MINIMUM CUTTING HEIGHT	2 IN.	2 IN.	2 IN.	2 IN.	2 IN.	2 IN.	2 IN.
CUTTING CAPACITY	4 IN.	4 IN.	4 IN.	4 IN.	4 IN.	4 IN.	4 IN.
DECK THICKNESS	.25 IN.	.25 IN.	.25 IN.	.25 IN.	.25 IN.	.25 IN.	.25 IN.
RECOMMENDED FLOW	15-25 GPM	15-25 GPM	26-32 GPM	33-40 GPM	15-25 GPM	26-32 GPM	33-40 GPM
REQUIRED LIFT CAPACITY	1200 LBS	1400 LBS	1400 LBS	1500 LBS	1500 LBS	1500 LBS	1600 LBS
WEIGHT	1120 LBS	1280 LBS	1280 LBS	1320 LBS	1360 LBS	1365 LBS	1405 LBS

* 5/8" and 3/4" Coupler Models Available, Please Contact Your Local Paladin Rep for More Information

GROUND SHARK™ STANDARD DUTY CONT.

GROUND SHARK™ STANDARD DUTY BRUSH CUTTER FOR SKID-STEER LOADERS



Note: We highly recommend the purchase of guarding to protect operator and machine from flying debris in harsh forestry and land clearing environments. Please refer to the SSL Forestry Guarding section on page 79 for more information. For Skid-Steer loaders only.

ATTACHES TO SKID-STEER UNIVERSAL HITCH	ORDER CODE	SHIP WEIGHT (LBS)
60" Standard Duty (15-25 GPM) with 1/2" couplers, no case drain	30360A-0022	1120
72" Standard Duty (15-25 GPM) with 1/2" couplers, no case drain	30372A-0022*	1280
72" Standard Duty (26-32 GPM) with 1/2" couplers, no case drain	30372B-0022*	1280
72" Standard Duty (33-40 GPM) with 1/2" couplers, with case drain	30372C-0022*	1320
78" Standard Duty (15-25 GPM) with 1/2" couplers, no case drain	30378A-0022*	1360
78" Standard Duty (26-32 GPM) with 1/2" couplers, no case drain	30378B-0022*	1365
78" Standard Duty (33-40 GPM) with 1/2" couplers, with case drain	30378C-0022*	1405

* 5/8" And 3/4" Coupler Models Available, Please Contact Your Local Paladin Rep for More Information

REPLACEMENT PARTS	ORDER CODE	SHIP WEIGHT (LBS)
Replacement Blade Kit - 60"	118330	40
Replacement Blade Kit - 72"	118331	45
Replacement Blade Kit - 78"	118332	50
Skid Shoe Kit	117810	9
Hose w/Sock .75x96 12MB-12MB 100R19 HS	38742	
Hose w/Sock .38x112 6FJ-8MB 100R2AT HS	38162	
Hose Coupler .38" body female QD 6 FF F 8FB	84928	
Hose Coupler .38" body male QD 6 FF M 8FB	84923	
Hose Coupler .50" body female QD 8 FF F 12FB	22518	
Hose Coupler .50" body female QD 8 FF M 12FB	22519	
Hose Coupler .625" body female QD 10 FF F 12FB	84921	
Hose Coupler .625" body male QD 10 FF M 12FB	84922	
Hose Coupler .75" body female QD 12 FF F 12FB	22520	
Hose Coupler .75" body male QD 12 FF M 12FB	22521	

OPTIONS	ORDER CODE	SHIP WEIGHT (LBS)
Dual Wheel Kit	118333	
MulchPower Gauge	117824	

BRUSH CUTTERS

GROUND SHARK™ HEAVY DUTY

BRUSH CUTTERS



- Deck steps on both sides to facilitate different carriers with entry on left or right side.
- The hydraulic hoses can be easily rerouted to allow hookup to multiple machine brands.
- Exclusive patented retractable cutting forward shield. When using the Ground Shark on brush/trees that are bigger than 4" in diameter, the shield will retract on its own to allow for maximum performance.
- Serrated Edges on Push Bar and Chassis front corners enable better control when moving material.
- The motor and valve assembly are fully shielded preventing contact with debris.
- Three 5/8" thick bevel edge blades on 66" model and four on 72" model. Forged from top grade steel for excellent cutting in most applications.
- Direct drive motor for efficient performance.
- The Ground Shark line of brush cutters include special hydraulic valving to shut the cutter head down quickly and safely. There is a distinct audible sound during the shutdown which will indicate to the operator that the blades are coming to a stop.
- Bi-directional operation allows operators to utilize both edges of each blade without having to rotate or change blades.
- Optional MulchPower™ gauge is visible to the operator and helps prevent excessive stalling and overheating.
- Blade retention bolt hex shank is design to prevent the bolt from rotating under extreme cutting conditions.
- Bolt on carbide stump grinding teeth increases mulching performance and takes the stump down to ground level.
- .25" thick steel deck design.

	GS66HD			GS72HD		
ORDER CODE	31766-0022	31766-9903	31766-9925	31772-0022	31772-9903	31772-9925
COUPLER SIZE	1/2 IN.	5/8 IN.	3/4 IN.	1/2 IN.	5/8 IN.	3/4 IN.
OVERALL HEIGHT	28.13 IN.	28.13 IN.	28.13 IN.	28.13 IN.	28.13 IN.	28.13 IN.
OVERALL WIDTH	71.13 IN.	71.13 IN.	71.13 IN.	77.13 IN.	77.13 IN.	77.13 IN.
OVERALL LENGTH	81.75 IN.	81.75 IN.	81.75 IN.	85.59 IN.	85.59 IN.	85.59 IN.
CUTTING WIDTH	66 IN.	66 IN.	66 IN.	72 IN.	72 IN.	72 IN.
MINIMUM CUTTING HEIGHT	2.5" IN.	2.5" IN.	2.5" IN.	2.5" IN.	2.5" IN.	2.5" IN.
MINIMUM STUMP GRINDING HEIGHT	.75 IN.	.75 IN.	.75 IN.	.5 IN.	.5 IN.	.5 IN.
CUTTING CAPACITY	7 IN.	7 IN.	7 IN.	7 IN.	7 IN.	7 IN.
DECK THICKNESS	.25 IN.	.25 IN.	.25 IN.	.25 IN.	.25 IN.	.25 IN.
RECOMMENDED FLOW	20-34 GPM	20-34 GPM	20-34 GPM	20-34 GPM	20-34 GPM	20-34 GPM
REQUIRED LIFT CAPACITY	2200 LBS	2200 LBS	2200 LBS	2200 LBS	2200 LBS	2200 LBS
WEIGHT	1605 LBS	1605 LBS	1605 LBS	1800 LBS	1800 LBS	1800 LBS

*Angled Front Allows Cut to Ground Level

GROUND SHARK™ HEAVY DUTY CONT.

GROUND SHARK™ HEAVY DUTY BRUSH CUTTER FOR SKID-STEER LOADERS



Note: We highly recommend the purchase of guarding to protect operator and machine from flying debris in harsh forestry and land clearing environments. Please refer to the SSL Forestry Guarding section on page 79 for more information. For Skid-Steer loaders only.

ATTACHES TO SKID-STEER UNIVERSAL HITCH	ORDER CODE	SHIP WEIGHT (LBS)
66" Heavy Duty (20-34 GPM) with 1/2" couplers, no case drain	31766-0022	1605
66" Heavy Duty (20-34 GPM) with 5/8" couplers, no case drain	31766-9903	1605
66" Heavy Duty (20-34 GPM) with 3/4" couplers, no case drain	31766-9925	1605
72" Heavy Duty (20-34 GPM) with 1/2" couplers, no case drain	31772-0022	1800
72" Heavy Duty (20-34 GPM) with 5/8" couplers, no case drain	31772-9903	1800
72" Heavy Duty (20-34 GPM) with 3/4" couplers, no case drain	31772-9925	1800

REPLACEMENT PARTS	ORDER CODE	SHIP WEIGHT (LBS)
Blade Kit - 66" Model	123735	
Blade Kit - 72" Model	123736	
Carbide Tooth Kit - 66" Model	117193	
Carbide Tooth Kit - 72" Model	123781	
Carbide Tooth - Individual	19917	
Carbide Tooth Nut - Crown Lock UNF	10003	
Skid Shoe Kit - 66" Model	123544	
Skid Shoe Kit - 72" Model	117192	
Hose w/Sock .75x96 12MB-12MB 100R19 HS	38742	
Hose w/Sock .38x112 6FJ-8MB 100R2AT HS	38162	
Hose Coupler .38" body female QD 6 FF F 8FB	84928	
Hose Coupler .38" body male QD 6 FF M 8FB	84923	
Hose Coupler .50" body female QD 8 FF F 12FB	22518	
Hose Coupler .50" body female QD 8 FF M 12FB	22519	
Hose Coupler .625" body female QD 10 FF F 12FB	84921	
Hose Coupler .625" body male QD 10 FF M 12FB	84922	
Hose Coupler .75" body female QD 12 FF F 12FB	22520	
Hose Coupler .75" body male QD 12 FF M 12FB	22521	

OPTIONS	ORDER CODE	SHIP WEIGHT (LBS)
MulchPower Gauge	123642	

BRUSH CUTTERS

GROUND SHARK™ HIGH PERFORMANCE

NEW PRODUCT

BRUSH CUTTERS



- Deck steps on both sides to facilitate different carriers with entry on left or right side.
- The hydraulic hoses can be easily rerouted to allow hookup to multiple machine brands.
- Exclusive patented retractable cutting forward shield. When using the Ground Shark on brush/trees that are bigger than 4" in diameter, the shield will retract on its own to allow for maximum performance.
- Serrated Edges on Push Bar and Chassis front corners enable better control when moving material.
- The motor and valve assembly are fully shielded preventing contact with debris.
- 3 blades 5/8" thick by 5" wide made from high grade abrasive resistant AR400 steel.
- Tri-lobe blade carrier 1" thick high grade steel.
- Blade retention bolt hex shank is design to prevent the bolt from rotating under extreme cutting conditions.
- Standard MulchPower™ gauge is visible to the operator and helps prevent excessive stalling and overheating.
- Bolt-on replaceable skid shoes.
- The Ground Shark line of brush cutters include special hydraulic valving to shut the cutter head down quickly and safely. There is a distinct audible sound during the shutdown which will indicate to the operator that the blades are coming to a stop.
- 84" deck plate constructed of thick .31" grade 50 KPSI thick steel.
- High torque radial piston direct drive hydraulic motor for more efficient power, improved startup and recovery.
- Higher recovery rate than extreme duty models.
- Optimized for horizontal cutting.

	GS72HP			GS84HP		
ORDER CODE	31872-0022	31872-9903	31872-9925	31884-0022	31884-9903	31884-9925
COUPLER SIZE	1/2 IN.	5/8 IN.	3/4 IN.	1/2 IN.	5/8 IN.	3/4 IN.
OVERALL HEIGHT	30.5 IN.	30.5 IN.	30.5 IN.	30.5 IN.	30.5 IN.	30.5 IN.
OVERALL WIDTH	77.13 IN.	77.13 IN.	77.13 IN.	89.13 IN.	89.13 IN.	89.13 IN.
OVERALL LENGTH	89.4 IN.	89.4 IN.	89.4 IN.	98.5 IN.	98.5 IN.	98.5 IN.
CUTTING WIDTH	72 IN.	72 IN.	72 IN.	84 IN.	84 IN.	84 IN.
MINIMUM CUTTING HEIGHT	2.5* IN.	2.5* IN.	2.5* IN.	2.5* IN.	2.5* IN.	2.5* IN.
CUTTING CAPACITY	10 IN.	10 IN.	10 IN.	10 IN.	10 IN.	10 IN.
DECK THICKNESS	.25 IN.	.25 IN.	.25 IN.	.31 IN.	.31 IN.	.31 IN.
RECOMMENDED FLOW	30-45 GPM	30-45 GPM	30-45 GPM	30-40 GPM	30-40 GPM	30-40 GPM
REQUIRED LIFT CAPACITY	2600 LBS	2600 LBS	2600 LBS	3000 LBS	3000 LBS	3000 LBS
WEIGHT	1895 LBS	1895 LBS	1895 LBS	2178 LBS	2178 LBS	2178 LBS

*Angled Front Allows Cut to Ground Level

GROUND SHARK™ HIGH PERFORMANCE CONT.

GROUND SHARK™ HIGH PERFORMANCE BRUSH CUTTER FOR SKID-STEER LOADERS



Note: We highly recommend the purchase of guarding to protect operator and machine from flying debris in harsh forestry and land clearing environments. Please refer to the SSL Forestry Guarding section on page 79 for more information. For Skid-Steer loaders only.

ATTACHES TO SKID-STEER UNIVERSAL HITCH	ORDER CODE	SHIP WEIGHT (LBS)
72" High Performance (30-45 GPM) with 1/2" couplers, with case drain	31872-0022	1895
72" High Performance (30-45 GPM) with 5/8" couplers, with case drain	31872-9903	1895
72" High Performance (30-45 GPM) with 3/4" couplers, with case drain	31872-9925	1895
84" High Performance (30-40 GPM) with 1/2" couplers, with case drain	31884-0022	2178
84" High Performance (30-40 GPM) with 5/8" couplers, with case drain	31884-9903	2178
84" High Performance (30-40 GPM) with 3/4" couplers, with case drain	31884-9925	2178

REPLACEMENT PARTS	ORDER CODE	SHIP WEIGHT (LBS)
Blade Kit - 72" & 84" Models	124686	
Skid Shoe Kit - 72" Model	117192	
Skid Shoe Kit - 84" Model	123343	
Hose w/Sock .75x96 12MB-12MB 100R19 HS	38742	
Hose w/Sock .38x112 6FJ-8MB 100R2AT HS	38162	
Hose Coupler .38" body female QD 6 FF F 8FB	84928	
Hose Coupler .38" body male QD 6 FF M 8FB	84923	
Hose Coupler .50" body female QD 8 FF F 12FB	22518	
Hose Coupler .50" body female QD 8 FF M 12FB	22519	
Hose Coupler .625" body female QD 10 FF F 12FB	84921	
Hose Coupler .625" body male QD 10 FF M 12FB	84922	
Hose Coupler .75" body female QD 12 FF F 12FB	22520	
Hose Coupler .75" body male QD 12 FF M 12FB	22521	

OPTIONS	ORDER CODE	SHIP WEIGHT (LBS)
MulchPower Gauge	Included	

BRUSH CUTTERS

GROUND SHARK™ EXTREME DUTY



- Deck steps on both sides to facilitate different carriers with entry on left or right side.
- The hydraulic hoses can be easily rerouted to allow hookup to multiple machine brands.
- Exclusive patented retractable cutting forward shield. When using the Ground Shark on brush/trees that are bigger than 4" in diameter, the shield will retract on its own to allow for maximum performance.
- Serrated Edges on Push Bar and Chassis front corners enable better control when moving material.
- The motor and valve assembly are fully shielded preventing contact with debris.
- Bolt-on replaceable skid shoes.
- High torque radial piston direct drive hydraulic motor for more efficient power, improved startup and recovery.
- The Ground Shark line of brush cutters include special hydraulic valving to shut the cutter head down quickly and safely. There is a distinct audible sound during the shutdown which will indicate to the operator that the blades are coming to a stop.
- Four 3/4" thick double bevel reversible edge blades machined from AR400 high strength steel for maximum cutting power and durability.
- Multi-fastener blade retention puck mount. 3 bolts hold puck in place for blade to swivel under extreme conditions.
- Pivoting blades are installed with an alternating blade cut angle. This enables cutting action like a swinging axe which clears the previous cut.
- Bolt-on carbide stump grinding teeth increases mulching performance and takes the stump down to ground level.

	GS72XD			GS78XD		
ORDER CODE	30272-0022	30272-9903	30272-9925	30278-0022	30278-9903	30278-9925
COUPLER SIZE	1/2 IN.	5/8 IN.	3/4 IN.	1/2 IN.	5/8 IN.	3/4 IN.
OVERALL HEIGHT	28.13 IN.	28.13 IN.	28.13 IN.	28.13 IN.	28.13 IN.	28.13 IN.
OVERALL WIDTH	77.13 IN.	77.13 IN.	77.13 IN.	83.13 IN.	83.13 IN.	83.13 IN.
OVERALL LENGTH	85.59 IN.	85.59 IN.	85.59 IN.	91.62 IN.	91.62 IN.	91.62 IN.
CUTTING WIDTH	72 IN.	72 IN.	72 IN.	78 IN.	78 IN.	78 IN.
MINIMUM CUTTING HEIGHT	3.25* IN.	3.25* IN.	3.25* IN.	3.25* IN.	3.25* IN.	3.25* IN.
MINIMUM STUMP GRINDING HEIGHT	.38 IN.	.38 IN.	.38 IN.	.38 IN.	.38 IN.	.38 IN.
CUTTING CAPACITY	10 IN.	10 IN.	10 IN.	10 IN.	10 IN.	10 IN.
DECK THICKNESS	.25 IN.	.25 IN.	.25 IN.	.25 IN.	.25 IN.	.25 IN.
RECOMMENDED FLOW	30-45 GPM	30-45 GPM	30-45 GPM	30-45 GPM	30-45 GPM	30-45 GPM
REQUIRED LIFT CAPACITY	2400 LBS	2400 LBS	2400 LBS	2700 LBS	2700 LBS	2700 LBS
WEIGHT	2008 LBS	2008 LBS	2008 LBS	2267 LBS	2267 LBS	2267 LBS

*Angled Front Allows Cut to Ground Level

GROUND SHARK™ EXTREME DUTY CONT.

GROUND SHARK™ EXTREME DUTY BRUSH CUTTER FOR SKID-STEER LOADERS



Note: We highly recommend the purchase of guarding to protect operator and machine from flying debris in harsh forestry and land clearing environments. Please refer to the SSL Forestry Guarding section on page 79 for more information. For Skid-Steer loaders only.

ATTACHES TO SKID-STEER UNIVERSAL HITCH	ORDER CODE	SHIP WEIGHT (LBS)
72" Extreme Duty (30-45 GPM) with 1/2" couplers, with case drain	30272-0022	2008
72" Extreme Duty (30-45 GPM) with 5/8" couplers, with case drain	30272-9903	2008
72" Extreme Duty (30-45 GPM) with 3/4" couplers, with case drain	30272-9925	2008
78" Extreme Duty (30-45 GPM) with 1/2" couplers, with case drain	30278-0022	2267
78" Extreme Duty (30-45 GPM) with 5/8" couplers, with case drain	30278-9903	2267
78" Extreme Duty (30-45 GPM) with 3/4" couplers, with case drain	30278-9925	2267

REPLACEMENT PARTS	ORDER CODE	SHIP WEIGHT (LBS)
Replacement Blade Kit - 72" & 78" models	117194	
Carbide Tooth Kit - 72" model	117193	
Carbide Tooth Kit - 78" model	123734	
Carbide Tooth - Individual	19917	
Carbide Tooth Nut - Crown Lock UNF	10003	
Skid Shoe Kit - 72" model	117192	
Skid Shoe Kit - 78" model	123639	
Hose w/Sock .38x107 6FJ-8MB 100R2AT HS	38665	
Hose w/Sock .75x108 12FJ-12MB 4K HS	37769	
Hose Coupler .38" body female QD 6 FF F 8FB	84928	
Hose Coupler .38" body male QD 6 FF M 8FB	84923	
Hose Coupler .50" body female QD 8 FF F 12FB	22518	
Hose Coupler .50" body female QD 8 FF M 12FB	22519	
Hose Coupler .625" body female QD 10 FF F 12FB	84921	
Hose Coupler .625" body male QD 10 FF M 12FB	84922	
Hose Coupler .75" body female QD 12 FF F 12FB	22520	
Hose Coupler .75" body male QD 12 FF M 12FB	22521	

OPTIONS	ORDER CODE	SHIP WEIGHT (LBS)
MulchPower Gauge	Included	

BRUSH CUTTERS

SSL GUARDING PACKAGES



Note: We highly recommend the purchase of guarding to protect operator and machine from flying debris in harsh forestry and land clearing environments. For Skid-Steer loaders only.

	ORDER CODE	SHIP WEIGHT (LBS)
SSL/CTL		
Universal Front Shield	W08290000	



KUBOTA GUARDING PACKAGE

	ORDER CODE	SHIP WEIGHT (LBS)
Model SVL95-2		
Complete Package: Top Guard, Working Light, Rear Grille Guard and Hyd Connection	WF8CFSVL2001	
Top Guard Kit, KU SVL Series	WF8290000	
Working Light Kit (FR/RR)	WF8290020	
Rear Grille Guard. KU SVL95-2	WF8290010	
Hydraulic Connection Guard Kit	WF8290030	
SSL SVL95-2s		
Def Cover, Kit, KU, SVL95-2S	WF8190000	
Kubota Excavator Cab Guarding		
Front Window Guard - Wire, KA KXX080-4, Enclosed Cab	WF1290060	

FORESTRY GUARDING PACKAGES



HYDRAULIC CONNECTION GUARDS

Heavy-duty formed 3/16" steel plate. Easy bolt-on installation – no welding. Complete Connect Under Pressure (CUP) manifold protection. Hinged guards for CUP manifold access.



REAR BUMPER

Heavy-duty formed steel plate construction. Bolt-on design requires no welding. Does not interfere with OEM tie-down hook access or compartment doors. Departure angle of 21°



REAR GRILL GUARD

Attaches to heavy duty rear bumper. Upper mounts weld to frame. Heavy-duty design protects radiator from debris while allowing ample airflow. Swings open to allow unhindered access to engine compartment.



SWEEP

Protects rear of machine from falling debris. Tool-less opening from the inside and out and hinges up for emergency egress.



TOP GUARD WITH LIGHT GUARDS

Supported by cab frame and held in place using existing rivnuts. Maintains top window visibility. Low profile design to avoid tree limbs. Includes light guards.



INTAKE SCREENS

Filters debris from entering air cooler area. Helps prevent overheating issues and prolongs life of coolers. Bolt-on (hole modification required), no welding required. Replaceable steel mesh screen design.



SIDE SCREENS

Heavy duty design to protect cab glass. Replaces OEM side screens for use in harsh environments.

CASE FORESTRY GUARDING PACKAGES

	ORDER CODE	SHIP WEIGHT (LBS)
Case SV300, SV340 & TV380 Tier 4B		
Hydraulic connection guards, FG	W28190000	
Assembly, rear bumper, SSL, FG	W28190010	
Rear grill guard, CS SSL/CTL T4F, FG	W28190060	
Sweep kit, CS CTL/SSL, 90HP T4F, FG	W28190070	
Top guard w light guards, FG	W28190040	
Additional intake screens, SV300, FG	W28190050	
Side screen kit, CS SSL/CTL T4F, FG	W28290000	

BRUSH CUTTERS

MX SERIES BRUSH CUTTER



- No-case-drain design and universal bolt-on mounting system means maximum fleet versatility for end-users and rental fleet owners
- Hinged debris shield provides the aggressive, full-depth cutting action of an open-deck design while limiting operator exposure to flying debris
- Patent-pending TiltLatch™ ensures debris shield stays closed with cutter is overhead, ensuring operator safety even in extreme-reach situations

Model	Machine Weight	Lift Capacity Required	Flow* (GPM)	Cutting Width	Max. Brush Size	Adapter Pattern
BC40MX10	3-6mT	700+ lbs	13-19	40"	4"	A
BC40MX20			19-26			
BC50MX10	5-8mT	1,140+ lbs	17-22	50"	5"	B or C
BC50MX20			22-34			
BC60MX10	7-10mT	1,440 lbs	20-28	60"	6"	B or C
BC60MX20			28-35			

*Flow shown is the required auxiliary flow to power the cutter, not the total machine flow

MX SERIES 40", 50" & 60" BRUSH CUTTER FOR MINI-EXCAVATORS



	DIMENSIONS**	ORDER CODE	WEIGHT** (LBS)
BC40MX10, no case drain	47" x 52" x 22"	125140A-BLNK	660
BC40MX20, no case drain	47" x 52" x 22"	125140B-BLNK	660
BC50MX10, no case drain	57" x 63" x 24"	125150A-BLNK	1,050
BC50MX20, no case drain	57" x 63" x 24"	125150B-BLNK	1,050
BC60MX10, no case drain	67" x 73" x 26"	125160A-BLNK	1,240
BC60MX20, no case drain	67" x 73" x 26"	125160B-BLNK	1,240

**Does not include pallet and other shipping dunnage.

ACCESSORIES	ORDER CODE	SHIP WEIGHT (LBS)
Double-bevel AR400 replacement blade kit (fits all models)	125090	-
Debris curtain replacement kit for 40" MX models	125090	-
Debris curtain replacement kit for 50" MX models	125133	-
Debris curtain replacement kit for 60" MX models	125134	-

TOP CAPS - "A" PATTERN	ORDER CODE	SHIP WEIGHT (LBS)
ASSY MTG TOP CAP A PATTERN F/BOBCAT MT55	28-11090-0128	-
ASSY MTG TOP CAP SF CORE 03T 30MM PIN	28-11090-03030	-
ASSY MTG TOP CAP SF CORE 03T 35MM PIN	28-11090-03035	-
ASSY MTG TOP CAP SF CORE 03T 40MM PIN	28-11090-03040	-
ASSY MTG TOP CAP A PATTERN F/DINGO	28-11090-0961	-
ASSY MTG TOP CAP A PATTERN F/TAK TB210R	28-11090-E0007	-
ASSY MTG TOP CAP A PATTERN F/YAN VIO17-A	28-11090-E0017	-

EXCAVATOR AUGERS ACCESSORIES CONTINUED NEXT PAGE

MX SERIES BRUSH CUTTER CONT.

TOP CAPS - "A" PATTERN	ORDER CODE	SHIP WEIGHT (LBS)
ASSY MTG TOP CAP A PATTERN F/YANMAR	28-11090-E0030	
ASSY MTG TOP CAP A PATTERN F/KUB KX41	28-11090-E0043	
ASSY MTG TOP CAP A PATTERN F/KOMATSU	28-11090-E0046	
ASSY MTG TOP CAP A PATTERN F/YANMAR	28-11090-E0050	
ASSY MTG TOP CAP A PATTERN F/KUBOTA	28-11090-E0091	
ASSY MTG TOP CAP A PATTERN F/KUBOTA K008	28-11090-E0117	
ASSY MTG TOP CAP A PATTERN F/KUB B26	28-11090-E0126	
ASSY MTG TOP CAP A PATTERN F/NH EC17	28-11090-E0179	
ASSY MTG TOP CAP A PATTERN F/WN 3503	28-11090-E0223	
ASSY MTG TOP CAP A PATTERN F/JD 35G	28-11090-E0228	
ASSY MTG TOP CAP A PATTERN F/CASE CX26C	28-11090-E0259	
ASSY MTG TOP CAP A PATTERN F/KOMATSU	28-11090-E0418	
ASSY MTG TOP CAP A PATTERN F/CASE CX37C	28-11090-E0535	
ASSY MTG TOP CAP A PATTERN F/HYUNDAI	28-11090-E0809	
ASSY MTG TOP CAP A PATTERN CP 027 QH	28-11090-E0852	
ASSY MTG TOP CAP A PATTERN F/KUBOTA	28-11090-E1043	
ASSY MTG TOP CAP A PATTERN F/VOLVO ECR58	28-11090-E1056	
ASSY MTG TOP CAP A PATTERN F/KUBOTA	28-11090-E1090	
ASSY MTG TOP CAP A PATTERN F/KUBOTA	28-11090-E1091	
ASSY MTG TOP CAP A PATTERN F/KUBOTA	28-11090-E1117	
ASSY MTG TOP CAP A PATTERN F/JD 17 ZTS	28-11090-E2017	
ASSY MTG TOP CAP A PATTERN F/SANY SY26	28-11090-E3026	
ASSY MTG TOP CAP A PATTERN F/BOBCAT	28-11090-E3055	
ASSY MTG TOP CAP TWC500 F/CAT 301.7D	28-11090-E3301	
ASSY MTG TOP CAP A PATTERN F/CAT 302.5C	28-11090-E3302	
ASSY MTG TOP CAP A PATTERN F/CAT 303.5E	28-11090-E3303	
ASSY MTG TOP CAP A PATTERN F/BRADCO 365	28-11090-E4365	
ASSY MTG TOP CAP A PATTERN F/JD 35G	28-11090-E5035	
ASSY MTG TOP CAP A PATTERN F/SANY SY35	28-11090-E6035	
ASSY MTG TOP CAP A PATTERN F/JCB 8018	28-11090-E8018	
ASSY MTG TOP CAP A PATTERN F/KUBOTA	28-11090-R1970	

TOP CAPS - "B" PATTERN	ORDER CODE	SHIP WEIGHT (LBS)
ASSY MTG TOP CAP B PATTERN 9 IN CTR	28-11091	-
ASSY MTG TOP CAP B PATTERN F/BOBCAT	28-11091-0128	-
ASSY MTG TOP CAP SF CORE 05T 30MM PIN	28-11091-05030	-
ASSY MTG TOP CAP SF CORE 05T 35MM PIN	28-11091-05035	-
ASSY MTG TOP CAP SF CORE 05T 40MM PIN	28-11091-05040	
ASSY MTG TOP CAP SF CORE 05T 45MM PIN	28-11091-05045	
ASSY MTG TOP CAP B PATTERN F/DINGO	28-11091-0961	
ASSY MTG TOP CAP B PATTERN F/AVANT QA	28-11091-0994	
ASSY MTG TOP CAP B PATTERN F/YANMAR	28-11091-E0017	

EXCAVATOR AUGERS ACCESSORIES CONTINUED NEXT PAGE

BRUSH CUTTERS

MX SERIES BRUSH CUTTER CONT.

TOP CAPS - "B" PATTERN	ORDER CODE	SHIP WEIGHT (LBS)
ASSY MTG TOP CAP B PATTERN F/YANMAR	28-11091-E0030	
ASSY MTG TOP CAP B PATTERN F/YANMAR	28-11091-E0050	
ASSY MTG TOP CAP B PATTERN F/TAK TB235	28-11091-E0135	
ASSY MTG TOP CAP B PATTERN F/JD 50G ZTS	28-11091-E0153	
ASSY MTG TOP CAP B PATTERN F/NH EC17	28-11091-E0179	
ASSY MTG TOP CAP B PATTERN F/JD 35 ZTS	28-11091-E0228	
ASSY MTG TOP CAP B PATTERN F/JD 26G	28-11091-E0229	
ASSY MTG TOP CAP B PATTERN F/CASE CX26C	28-11091-E0259	
ASSY MTG TOP CAP B PATTERN F/CAT 304CCR	28-11091-E0304	
ASSY MTG TOP CAP B PATTERN CP 030 QH	28-11091-E0333	
ASSY MTG TOP CAP B PATTERN CP 027 QH	28-11091-E0852	
ASSY MTG TOP CAP B PATTERN F/SANY SY16	28-11091-E1016	
ASSY MTG TOP CAP B PATTERN F/JCB 55Z	28-11091-E1057	
ASSY MTG TOP CAP B PATTERN F/CASE CX60C	28-11091-E1060	
ASSY MTG TOP CAP B PATTERN F/KUBOTA	28-11091-E1090	
ASSY MTG TOP CAP B PATTERN F/KUBOTA	28-11091-E1091	
ASSY MTG TOP CAP B PATTERN F/BOBCAT E45	28-11091-E1450	
ASSY MTG TOP CAP B PATTERN F/BOBCAT E35	28-11091-E1535	
ASSY MTG TOP CAP B PATTERN F/JD 17G ZTS	28-11091-E2017	
ASSY MTG TOP CAP B PATTERN F/SANY SY10	28-11091-E2510	
ASSY MTG TOP CAP B PATTEF/BOBCAT X-CHNGE	28-11091-E3055	
ASSY MTG TOP CAP B PATTERN F/CAT 303.5E	28-11091-E3303	
ASSY MTG TOP CAP B PATTERN F/TEREX TX16	28-11091-E4015	
ASSY MTG TOP CAP B PATTERN F/KUBOTA	28-11091-E5057	
ASSY MTG TOP CAP B PATTERN F/SANY SY35U	28-11091-E6035	
ASSY MTG TOP CAP B PATTERN F/SANY SY60	28-11091-E6060	
ASSY MTG BREAKER B PATTERN F/JD 60P	28-11091-E7060	
ASSY MTG TOP CAP B PATTERN F/SANY SY50	28-11091-E8050	
ASSY MTG TOP CAP B PATTERN F/JCB 210	28-11091-R0210	
ASSY MTG TOP CAP B PATTERN F/NH B110B	28-11091-R3110	
ASSY MTG TOP CAP B PATTERN F/NH B90B	28-11091-R3555	

TOP CAPS - "C" PATTERN	ORDER CODE	SHIP WEIGHT (LBS)
ASSY MTG TOP CAP C PATTERN SF CORE 08T	28-10973-08035	
ASSY MTG TOP CAP C PATTERN SF CORE 08T	28-10973-08040	
ASSY MTG TOP CAP C PATTERN SF CORE 08T	28-10973-08045	
ASSY MTG TOP CAP C PATTERN SF CORE 08T	28-10973-08050	
ASSY MTG TOP CAP C PATTERN SF CORE 09T	28-10973-09045	
ASSY MTG TOP CAP C PATTERN SF CORE 09T	28-10973-09050	
ASSY MTG TOP CAP C PATTERN F/ YAN VIO35	28-10973-E0030	
ASSY MTG TOP CAP C PATTERN F/ WN EZ38	28-10973-E0038	
ASSY MTG TOP CAP C PATTERN F/TAK TB250	28-10973-E0045	
ASSY MTG TOP CAP C PATTERN F/KOMATSU	28-10973-E0046	
ASSY MTG TOP CAP C PATTERN F/ YAN VIO45	28-10973-E0050	

EXCAVATOR AUGERS ACCESSORIES CONTINUED NEXT PAGE

MX SERIES BRUSH CUTTER CONT.

TOP CAPS - "C" PATTERN	ORDER CODE	SHIP WEIGHT (LBS)
ASSY MTG TOP CAP C PATTERN F/KOM PC78	28-10973-E0060	
ASSY MTG TOP CAP C PATTERN F/ TAK TB285	28-10973-E0071	
ASSY MTG TOP CAP C PATTERN F/JD 85G	28-10973-E0081	
ASSY MTG TOP CAP C PATTERN F/TAK TB135	28-10973-E0135	
ASSY MTG TOP CAP C PATTERN F/JD 50G ZTS	28-10973-E0153	
ASSY MTG TOP CAP C PATTERN F/WN EZ38	28-10973-E0223	
ASSY MTG TOP CAP C PATTERN F/JD 35D ZTS	28-10973-E0228	
ASSY MTG TOP CAP C PATTERN F/NH E30C	28-10973-E0259	
ASSY MTG TOP CAP C PATTERN F/CAT 305E	28-10973-E0304	
ASSY MTG TOP CAP C PATTERN F/CP 030	28-10973-E0333	
ASST MTG TOP CAP C PATTERN F/ WN EZ53	28-10973-E0503	
ASSY MTG TOP CAP C PATTERN F/JCB 8035	28-10973-E0803	
ASSY MTG TOP CAP C PATTERN F/ CP 027	28-10973-E0852	
ASSY MTG TOP CAP C PATTERN F/WAIN-ROY	28-10973-E0957	
ASSY MTG TOP CAP C PATTERN F/VOLVO ECR58	28-10973-E1056	
ASSY MTG TOP CAP C PATTERN F/JCB 55Z	28-10973-E1057	
ASSY MTG TOP CAP C PATTERN F/CASE CX60C	28-10973-E1060	
ASSY MTG TOP CAP C PATTERN F/KUB K7974	28-10973-E1090	
ASSY MTG TOP CAP C PATTERN F/KUB K7870	28-10973-E1091	
ASSY MTG TOP CAP C PATTERN F/KOM WB150	28-10973-E1140	
ASSY MTG TOP CAP C PATTERN F/KUB K7880	28-10973-E1151	
ASSY MTG TOP CAP C PATTERN F/YAN VIO80	28-10973-E1171	
ASSY MTG TOP CAP D PATTERN F/DOOSAN DX50	28-10973-E1450	
ASSY MTG TOP CAP C PATTERN F/CASE CX80	28-10973-E1600	
ASSY MTG TOP CAP C PATTERN F/TAK TB230	28-10973-E2026	
ASSY MTG TOP CAP C PATTERN F/IHI 35NX	28-10973-E2035	
ASSY MTG TOP CAP C PATTERN F/CASE CX50B	28-10973-E2051	
ASSY MTG TOP CAP C PATTERN F/KOB SLQT	28-10973-E2070	
ASSY MTG TOP CAP C PATTERN F/KUB K9930	28-10973-E2091	
ASSY MTG TOP CAP C PATTERN F/TAKEUCHI	28-10973-E2260	
ASSY MTG TOP CAP C PATTERN F/BOB X-CNG	28-10973-E3055	
ASSY MTG TOP CAP C PATTERN F/CAT 303.5E	28-10973-E3303	
ASSY MTG TOP CAP C PATTERN F/CAT 304 CR	28-10973-E3304	
ASSY MTG TOP CAP C PATTERN F/CASE CX36B	28-10973-E3354	
ASSY MTG TOP CAP C PATTERN F/VOLVO ECR38	28-10973-E4035	
ASSY MTG TOP CAP C PATTERN F/KUB K7402	28-10973-E4080	
ASSY MTG TOP CAP C PATTERN F/JD 50G/60G	28-10973-E5050	
ASSY MTG TOP CAP C PATTERN F/ KUB KX057	28-10973-E5055	
ASSY MTG TOP CAP C PATTERN F/KUBOTA	28-10973-E5056	
ASSY MTG TOP CAP C PATTERN F/KUB KX057	28-10973-E5057	
ASSY MTG TOP CAP C PATTERN F/KUB K9940	28-10973-E5059	
ASSY MTG TOP CAP C PATTERN F/KUBOTA	28-10973-E5080	
ASSY MTG TOP CAP C PATTERN F/SANY SY35U	28-10973-E6035	
ASSY MTG TOP CAP C PATTERN F/JD 60G***	28-10973-E7065	
ASSY MTG TOP CAP C PATTERN F/SANY SY50	28-10973-E8050	
ASSY MTG TOP CAP C PATTERN F/SANY SY95	28-10973-E8095	

BRUSH CUTTERS

MX SERIES BRUSH CUTTER CONT.

TOP CAPS - "C" PATTERN	ORDER CODE	SHIP WEIGHT (LBS)
ASSY MTG TOP CAP C PATTERN F/SANY SY35U	28-10973-E8935	
ASSY MTG TOP CAP C PATTERN F/JD 310L	28-10973-R0009	
ASSY MTG TOP CAP C PATTERN F/JD 310 SL	28-10973-R0010	
ASSY MTG TOP CAP C PATTERN F/JCB 214	28-10973-R0214	
ASSY MTG TOP CAP C PATTERN F/CASE 580M/	28-10973-R0580	
ASSY MTG TOP CAP C PATTERN F/CASE***	28-10973-R2580	
ASSY MTG TOP CAP C PATTERN F/NH LB 95B	28-10973-R3555	
ASSY MTG TOP CAP C PATTERN F/CASE 580 SN	28-10973-R3580	

BUCKETS



BUCKETS

BUCKETS



Paladin Attachments has a variety of buckets to suit your needs. From light material buckets to heavy duty material buckets to special purpose buckets, our attachments can increase your productivity - saving you time and money.

Since many of our buckets are customized to your needs, when you place your order you will need to choose your bucket, the mounting, hydraulic kit (if needed), and any options you would like. As you look through the products, notice the red headings in the charts - they will alert you to the choices you need to make.

Choose your bucket - be sure to check loader capacity before ordering

BUCKET		
CHECK LOADER CAPACITY BEFORE ORDERING		
	ORDER CODE	SHIP WEIGHT (LBS)
(75 degree back)		
73" OD Construction 4-in-1	LAF0976	1390
78" OD Construction 4-in-1	LAF0977	1475
82" OD Construction 4-in-1	LAF0985	1540
87" OD Construction 4-in-1	LAF0990	1620
(Designed for Track Machines)		
84" OD Construction 4-in-1 (70° back)	LAF0988	1343
90" OD Construction 4-in-1 (70° back)	LAF0992	1434

Price of loader mounting must be added to the attachment price

Choose a mount

MOUNTING		
ADDITIONAL COST MAY APPLY		
	ORDER CODE	SHIP WEIGHT (LBS)
Contact Customer Service at (833) 723-1843		

Decide what options you want

OPTIONS		
EXCLUSIVE TO FFC BUCKETS		
	ORDER CODE	SHIP WEIGHT (LBS)
Extra Heavy-Duty Toothbar for Buckets with Bolt-On Edge		
For Bucket LAF0976 with 8 teeth	LAF9173-FF41	
For Bucket LAF0977 with 9 teeth	LAF9179-FF41	
For Bucket LAF0985 with 9 teeth	LAF9183-FF41	
For Bucket LAF0988	10640	
For Bucket LAF0992	10641	

Be sure to look for the warning symbol- this box contains important information pertaining to that particular bucket and how it will attach to your prime mover



IMPORTANT: FFC Skid-Steer buckets have a 70° angle on the back. This may increase or decrease the effective rollback and dump angles of your Skid-Steer. Specify Skid-Steer make and model when ordering.

If you have any questions about placing your order, contact Customer Service at (833) 723-1843.

LOW-PROFILE LONG FLOOR BUCKET



- 36" long floor buckets for better visibility, productivity and cutting grade
- High strength side cutters tie into the front edge for better strength and longer life

LOW-PROFILE LONG FLOOR BUCKETS FOR SKID-STEER LOADERS



	ORDER CODE	SHIP WEIGHT (LBS)
60" bucket (15.8 ft ³) 7 holes/9" spacing	15111	467
60" bucket with 6 teeth	33862	510
63" bucket 9 holes/7" spacing	33808	426
63" bucket LPLF, bolt on tooth ready	121592	567
66" bucket (17.5 ft ³) 7 holes/10" spacing	15115	500
66" bucket with 7 teeth	33866	550
68" bucket (18.4 ft ³) 7 holes/10" spacing	115925	490
68" bucket with 8 teeth	115926	548
68" bucket LPLF, bolt on tooth ready	121603	506
72" bucket (19.2 ft ³) 7 holes/11" spacing	15117	533
72" bucket with 8 teeth	33868	590
75" bucket LPLF, bolt on tooth ready	121742	576
78" bucket (20.9 ft ³) 9 holes/9" spacing	16271	608
78" bucket with 8 teeth	16266	665
80" bucket LPLF, bolt on tooth ready	121737	704
82" bucket (22.0 ft ³) 9 holes/9.75" spacing	15119	631
82" bucket with 9 teeth	33870	695
84" bucket (22.7 ft ³) 9 holes/9.75" spacing	16181	641
84" bucket with 9 teeth	16191	705
84" bucket LPLF, bolt on tooth ready	121745	728



"DIRT-READY" LOW-PROFILE LONG FLOOR BUCKETS FOR SKID-STEER LOADERS

"DIRT READY" BUCKETS INCLUDE SIDE CUTTERS AND EITHER BOE OR TEETH	ORDER CODE	SHIP WEIGHT (LBS)
60" bucket LPLF w/BOE and side cutters	KD15111	816
60" bucket LPLF w/teeth and side cutters	KD33862	767
63" bucket LPLF w/BOE and side cutters	KD33808	575
66" bucket LPLF w/BOE and side cutters	KD15115	741
66" bucket LPLF w/teeth and side cutters	KD33866	696
68" bucket LPLF w/BOE and side cutters	KD111712	680
68" bucket LPLF w/teeth and side cutters	KD111713	628
72" bucket LPLF w/teeth and side cutters	KD113903	650
72" bucket LPLF w/BOE and side cutters	KD113902	710
72" bucket LPLF w/teeth	KD118653	618

"DIRT-READY" LOW-PROFILE LONG FLOOR BUCKETS CONTINUED ON NEXT PAGE

BUCKETS

BUCKETS

LOW-PROFILE LONG FLOOR BUCKET CONT. "DIRT-READY" LOW-PROFILE LONG FLOOR BUCKETS FOR SKID-STEER LOADERS

"DIRT READY" BUCKETS INCLUDE SIDE CUTTERS AND EITHER BOE OR TEETH	ORDER CODE	SHIP WEIGHT (LBS)
75" bucket LPLF w/teeth	KD118662	650
75" bucket LPLF w/BOE and side cutters	121487	778
75" bucket LPLF w/teeth and side cutters	125924	765
78" bucket LPLF w/BOE and side cutters	KD16271	710
78" bucket LPLF w/teeth and side cutters	KD16266	680
80" bucket LPLF w/BOE and side cutters	KD111754	798
80" bucket LPLF w/teeth and side cutters	KD111755	740
82" bucket LPLF w/BOE and side cutters	KD15119	795
82" bucket LPLF w/teeth and side cutters	KD33870	752
84" bucket LPLF w/BOE and side cutters	KD16181	954
84" bucket LPLF w/teeth and side cutters	KD16191	924
90" bucket LPLF w/teeth & side cutters	239641	800
90" bucket LPLF w/BOE and side cutters	239642	815
96" bucket LPLF w/teeth & side cutters	239665	845
96" bucket LPLF w/BOE and side cutters	239666	860

LOW-PROFILE STANDARD FLOOR BUCKET



- 30" standard floor buckets
- High strength side cutters tie into the front edge for better strength and longer life



LOW-PROFILE STANDARD FLOOR BUCKETS FOR SKID-STEER LOADERS

	ORDER CODE	SHIP WEIGHT (LBS)
60" bucket (12.7 ft ³) 7 holes/9" spacing	15120	412
60" bucket with 6 teeth	33861	455
63" bucket 9 holes/7" spacing	33807	426
63" bucket LPSF, bolt on tooth ready	121596	464
66" bucket (14.1 ft ³) 7 holes/10" spacing	15114	440
66" bucket with 7 teeth	33865	490
68" bucket (14.8 ft ³) 7 holes/10" spacing	115923	451
68" bucket with 8 teeth	115924	509
68" bucket LPSF, bolt on tooth ready	121599	465
72" bucket (15.4 ft ³) 7 holes/11" spacing	15116	473
72" bucket with 8 teeth	33867	530
75" bucket LPSF, bolt on tooth ready	121756	634
78" bucket (16.7 ft ³) 9 holes/9" spacing	16270	543
78" bucket with 8 teeth	16265	600

LOW-PROFILE STANDARD FLOOR BUCKETS CONTINUED ON NEXT PAGE

LOW-PROFILE STANDARD FLOOR BUCKET CONT.

LOW-PROFILE STANDARD FLOOR BUCKETS FOR SKID-STEER LOADERS CONT.



	ORDER CODE	SHIP WEIGHT (LBS)
80" bucket LPSF, bolt on tooth ready	121606	560
82" bucket (17.6 ft ³) 9 holes/9.75" spacing	15118	566
82" bucket with 9 teeth	33869	630
84" bucket (18.1 ft ³) 9 holes/9.75" spacing	16180	576
84" bucket with 9 teeth	16190	640
84" bucket LPSF, bolt on tooth ready	121759	683

"DIRT READY" LOW-PROFILE STANDARD FLOOR BUCKETS FOR SKID-STEER LOADERS

"DIRT READY" BUCKETS INCLUDE SIDE CUTTERS AND EITHER BOE OR TEETH	ORDER CODE	SHIP WEIGHT (LBS)
60" bucket LPSF w/BOE and side cutters	KD15120	522
60" bucket LPSF w/teeth and side cutters	KD33861	473
63" bucket LPSF w/BOE and side cutters	KD33807	661
66" bucket LPSF w/BOE and side cutters	KD15114	695
66" bucket LPSF w/teeth and side cutters	KD33865	651
68" bucket LPSF w/BOE and side cutters	KD111813	642
68" bucket LPSF w/teeth and side cutters	KD111814	588
72" bucket LPSF w/BOE and side cutters	KD113900	669
72" bucket LPSF w/teeth	KD118652	587
72" bucket LPSF w/teeth and side cutters	KD113901	608
75" bucket LPSF	KD118685	685
75" bucket LPSF w/teeth	KD118686	743
78" bucket LPSF w/BOE and side cutters	KD16270	792
78" bucket LPSF w/teeth and side cutters	KD16265	751
80" bucket LPSF w/BOE and side cutters	KD111838	760
80" bucket LPSF w/teeth and side cutters	KD111839	696
84" bucket LPSF w/BOE and side cutters	KD16180	916
84" bucket LPSF w/teeth and side cutters	KD16190	780

BUCKETS

BUCKET ACCESSORIES FOR BRADCO LOW-PROFILE, HIGH CAPACITY BUCKETS

	ORDER CODE	SHIP WEIGHT (LBS)
Extreme-Duty Bucket Options		
Bolt-on side cutter assembly (pair) (shown)	107786	18
Assembly charge to attach bucket edge at factory (net cost per each unit assembled)		
Bolt-On Edge Assembly		
60" (7 holes, 9" spacing)	15025	124
63" (7 holes, 9.63" spacing)*	121762	102
63" (9 holes, 7" spacing)	33816	106
66" (7 holes, 10" spacing)	15027	110
68" (7 holes, 10" spacing)	111726	110
68" (7 holes, 10.59" spacing)**	121763	111
72" (7 holes, 11" spacing)	15028	120
72" (12 holes, 6" spacing)	33818	121
75" (8 holes, 10" spacing)	18880	125
75" (8 holes, 9.94" spacing)¥	121764	122
78" (9 holes, 9" spacing)	16204	130
80" (7 holes, 12" spacing)	89578	132
80" (8 holes, 10.81" spacing)€	121765	130
82" (9 holes, 9.75" spacing)	15029	136
82" (10 holes, 8" spacing)	33819	136
84" (9 holes, 9.75" spacing)Σ	16183	203
96" (9 holes, 10.83" spacing)	11002	160
Tooth Bar Assembly		
Bucket tooth assembly bolt on with hardware (use with bolt on tooth buckets)	121672	-
Side Cutter Kit, bolt on option	107786	-
60" side cutter mounting tooth bar assembly (standard)	112890	83
60" over the edge side cutter mounting tooth bar (over bolt-on edge)	112900	105
63" side cutter mounting tooth bar assembly (standard)*	112892	92
63" over the edge side cutter mounting tooth bar (over bolt-on edge)	112902	117
66" side cutter mounting tooth bar assembly (standard)	112894	93
66" over the edge side cutter mounting tooth bar (over bolt-on edge)	112904	119
68" side cutter mounting tooth bar assembly (standard)**	113380	94
68" over the edge side cutter mounting tooth bar (over bolt-on edge)	113381	127
72" side cutter mounting tooth bar assembly (standard)	110738	100
72" over the edge side cutter mounting tooth bar (over bolt-on edge)	110744	130
75" side cutter mounting tooth bar assembly (standard)	112771	106
75" over the edge side cutter mounting tooth bar (over bolt-on edge)	112773	132
75" side cutter mounting tooth bar assembly (standard)¥	121767	103
78" side cutter mounting tooth bar assembly (standard)	110740	109
78" over the edge side cutter mounting tooth bar (over bolt-on edge)	110746	132
80" side cutter mounting tooth bar assembly (standard)	112896	114
TOOTH BAR ASSEMBLY CONTINUED ON NEXT PAGE		



*use with 121596, 121592, 121748

**use with 121599, 121603, 121753

¥ use with 121756, 121742, 121680

€ use with 121606, 121737, 121654

Σ use with 121759, 121745, 121674

BUCKET ACCESSORIES FOR BRADCO LOW-PROFILE, HIGH CAPACITY BUCKETS CONT.

	ORDER CODE	SHIP WEIGHT (LBS)
Tooth Bar Assembly cont.		
80" over the edge side cutter mounting tooth bar (over bolt-on edge)	112906	137
80" side cutter mounting tooth bar assembly (standard)€	121768	140
82" side cutter mounting tooth bar assembly (standard)	112898	129
82" over the edge side cutter mounting tooth bar (over bolt-on edge)	112908	146
84" side cutter mounting tooth bar assembly (standard)	110742	129
84" over the edge side cutter mounting tooth bar (over bolt-on edge)	110748	147
84" side cutter mounting tooth bar assembly (standard)Σ	121769	151
Spill Guard for High Capacity Buckets		
63" spill guard assembly (use with 121748)	122040	23
68" spill guard assembly (use with 121753)	122041	25
75" spill guard assembly (use with 121680)	122042	28
80" spill guard assembly (use with 121654)	122035	30
84" spill guard assembly (use with 121674)	122043	31

*use with 121596, 121592, 121748

**use with 121599, 121603, 121753

¥ use with 121756, 121742, 121680

€ use with 121606, 121737, 121654

Σ use with 121759, 121745, 121674

BUCKETS

4-IN-1 MULTI-PURPOSE STANDARD DUTY BUCKETS



- Ideal for site clean up, grading, scraping, grappling, dozing and brush removal
- Single bevel bolt on dozer edge, double bevel bolt on clam edges, front and back - these features are exclusive to FFC
- Many sizes available

Carrier Specifications	
Lift Capacity	Operating Weight
<9,000 lbs.	<11,000 lbs.

IMPORTANT: Prime Movers with tracks and with an operating weight of 7,000 lbs. or more MUST have port reliefs installed on the prime mover's main control valve to protect both sides of the auxiliary circuit.

Specifications								
Model #	Weight (Approx)	Degree Back	Width OD	Height	Depth	Clamshell Opening	Capacity Struck	Capacity Heaped
LAF0976	1390 lbs	75°	73"	21.5"	32"	29.4"	0.51 yd ³	0.66 yd ³
LAF0977	1475 lbs	75°	78"	21.5"	32"	29.4"	0.52 yd ³	0.71 yd ³
LAF0985	1540 lbs	75°	82"	21.5"	32"	29.4"	0.55 yd ³	0.75 yd ³
LAF0988	1343 lbs	75°	84"	21.5"	32"	29.4"	0.63 yd ³	0.90 yd ³
LAF0990	1400 lbs	75°	87"	21.5"	32"	29.4"	0.59 yd ³	0.80 yd ³
LAF0992	1434 lbs	75°	90"	21.5"	32"	29.4"	0.67 yd ³	0.97 yd ³

4-IN-1 MULTI-PURPOSE STANDARD DUTY BUCKETS FOR SKID-STEER LOADERS



INCLUDES: BUCKET, MOUNT, HOSES AND COUPLERS FOR SKID-STEERS ONLY. TO COMPLETE A BUCKET ASSEMBLY: CHOOSE A BUCKET AND MOUNTING

BUCKET	ORDER CODE	SHIP WEIGHT (LBS)
CHECK LOADER CAPACITY BEFORE ORDERING		
(75 degree back)		
73" OD Construction 4-in-1	LAF0976-0022	1390
78" OD Construction 4-in-1	LAF0977-0022	1475
82" OD Construction 4-in-1	LAF0985-0022	1540
(Designed for Track Machines)		
84" OD Construction 4-in-1 (70° back)	LAF0988-0022	1343
90" OD Construction 4-in-1 (70° back)	LAF0992-0022	1434

Price of loader mounting must be added to the attachment price

MOUNTING	ORDER CODE	SHIP WEIGHT (LBS)
ADDITIONAL COST MAY APPLY		
Contact Customer Service at (833) 723-1843		

4-IN-1 MULTI-PURPOSE STANDARD DUTY BUCKETS CONT.

4-IN-1 MULTI-PURPOSE STANDARD DUTY BUCKETS FOR SKID-STEER LOADERS CONT.

OPTIONS EXCLUSIVE TO FFC BUCKETS	ORDER CODE	SHIP WEIGHT (LBS)
Extra Heavy-Duty Toothbar for Buckets with Bolt-On Edge		
For Bucket LAF0976 with 8 teeth	LAF9173-FF41	
For Bucket LAF0977 with 9 teeth	LAF9179-FF41	
For Bucket LAF0985 with 9 teeth	LAF9183-FF41	
For Bucket LAF0990 with 9 teeth	LAF9188-FF41	
For Bucket LAF0988	10640	
For Bucket LAF0992	10641	

4-IN-1 MULTI-PURPOSE HEAVY-DUTY BUCKETS



- Ideal for site clean up, grading, scraping, grappling, dozing and brush removal
- Single bevel bolt on dozer edge, double bevel bolt on clam edges, front and back - these features are exclusive to FFC
- Many sizes available
- Double .25" plate steel clamshell reinforced with .75" x 6" cutting edge front, .50" x 6" back and .50" wearbars; Wear-resistant Pacal steel tapered cutting edge: .75" x 6"; Wear-resistant Pacal steel tapered dozer edge; End plates: .375" with mounting brackets.

Carrier Specifications	
Lift Capacity	Operating Weight
<10,000 lbs.	<20,000 lbs.

IMPORTANT: Prime Movers with tracks and with an operating weight of 7,000 lbs. or more **MUST** have port reliefs installed on the prime mover's main control valve to protect both sides of the auxiliary circuit.

Specifications							
Model #	Weight (Approx)	Width OD	Height	Depth	Clamshell Opening	Capacity Struck	Capacity Heaped
LAF3182	1220 lbs	82"	34.5"	24.8"	41"	0.81 yd ³	0.99 yd ³
LAF3190	1295 lbs	90"	34.5"	24.8"	41"	0.89 yd ³	1.10 yd ³
LAF3196	1470 lbs	96"	34.5"	24.8"	41"	0.95 yd ³	1.18 yd ³

BUCKETS

4-IN-1 MULTI-PURPOSE HEAVY-DUTY BUCKETS FOR BACKHOE LOADERS



**INCLUDES: BUCKET, MOUNT, HOSES AND COUPLERS FOR SKID-STEERS ONLY.
TO COMPLETE A BUCKET ASSEMBLY: CHOOSE A BUCKET AND MOUNTING**

BUCKET

CHECK LOADER CAPACITY BEFORE ORDERING

	ORDER CODE	SHIP WEIGHT (LBS)
82" OD Construction 4-in-1 Heavy-Duty	LAF3182-0733	1220
90" OD Construction 4-in-1 Heavy-Duty	LAF3190-0733	1295
96" OD Construction 4-in-1 Heavy-Duty	LAF3196-0733	1470

MOUNTING

ADDITIONAL COST MAY APPLY

	ORDER CODE	SHIP WEIGHT (LBS)
Contact Customer Service at (833) 723-1843		

OPTIONS - REVERSIBLE CUTTING EDGE KIT

INCLUDES BOE, GRADE 8 PLOW BOLTS, LOCK WASHERS & NUTS
FOR FRONT EDGE ONLY

	ORDER CODE	SHIP WEIGHT (LBS)
For Bucket LAF3182 (9 holes, 9.75" spacing)*	15029	136
For Bucket LAF3190 (10 holes, 9" spacing)*	113991	150
For Bucket LAF3196 (9 holes, 10.82" spacing)*	11002	160

For Optional Bolt-On Edge Drill Patterns (i.e. Case Hole Patterns) - Call (833) 723-1843

4-IN-1 MULTI-PURPOSE BUCKETS



Functions as a loader bucket, clam, dozer, scraper, and bottom dump bucket

Strong hinges & pins to distribute load

Replacement bolt-on wear edge, bolt-on tooth bars, and bolt-on tooth bars that fit over weld-on wear edge

Options: Bolt-on side cutters, spill guards

Carrier Specifications	
Lift Capacity	Operating Weight
<9,000 lbs.	<11,000 lbs.



IMPORTANT: Prime Movers with tracks and with an operating weight of 7,000 lbs. or more MUST have port reliefs installed on the prime mover's main control valve to protect both sides of the auxiliary circuit.

Specifications					
Width	Weight (Approx)	Height	Grapple Depth	Heaped Opening	Capacity
Utility					
60"	585 lbs	27.32"	34.5"	35"	14.25 cu/ft
66"	620 lbs	27.32"	34.5"	35"	15.75 cu/ft
72"	655 lbs	27.32"	34.5"	35"	17.25 cu/ft
Construction					
72"	900 lbs	27.69"	37.47"	34.79"	19.99 cu/ft
78"	935 lbs	27.69"	37.47"	34.79"	21.69 cu/ft
84"	975 lbs	27.69"	37.47"	34.79"	23.4 cu/ft
Euro Global ISO23206					
72"	940 lbs	27.69"	37.47"	34.79"	19.99 cu/ft
78"	975 lbs	27.69"	37.47"	34.79"	21.69 cu/ft
84"	1015 lbs	27.69"	37.47"	34.79"	23.4 cu/ft

4-IN-1 MULTI-PURPOSE BUCKETS FOR SKID-STEER LOADERS





INCLUDES: BUCKET AND UNIVERSAL SSL MOUNT.
TO COMPLETE A BUCKET ASSEMBLY: CHOOSE A BUCKET AND MOUNTING

BUCKETS 4-IN-1 CONSTRUCTION & UTILITY	ORDER CODE	SHIP WEIGHT (LBS)
Utility Buckets 4-in-1 Bucket With & Without Teeth Universal Mount		
60" utility bucket no hoses	111470	585
66" utility bucket no hoses	108018	620
66" utility bucket with teeth, no hoses	108019	675
72" utility bucket no hoses	108020	655
72" utility bucket with teeth, no hoses	108021	713
Construction Buckets 4-in-1 Bucket With & Without Teeth Universal Mount		
72" construction bucket no hoses	108022	900
72" construction bucket with teeth, no hoses	108023	958
78" construction bucket no hoses	108024	935
78" construction bucket with teeth, no hoses	108025	993
84" construction bucket no hoses	108026	975
84" construction bucket with teeth, no hoses	108027	1040

BUCKETS

4-IN-1 MULTI-PURPOSE BUCKETS CONT.

4-IN-1 MULTI-PURPOSE BUCKETS FOR SKID-STEER LOADERS CONT.



BUCKETS

BUCKETS 4-IN-1 CONSTRUCTION & UTILITY		ORDER CODE	SHIP WEIGHT (LBS)
Construction Euro Global ISO 23206 Mount 4-in-1 Buckets			
72" construction bucket no hoses		111190	940
78" construction bucket no hoses		111777	975
84" construction bucket no hoses		111778	1015
HYDRAULIC KITS (SOLD SEPARATELY)		ORDER CODE	SHIP WEIGHT (LBS)
66" long hose kit with flat face couplers		103577	10
75" long hose kit with flat face couplers		105845	13
94" long hose kit with flat face couplers		103603	10
OPTIONS UTILITY BUCKET OPTIONS		ORDER CODE	SHIP WEIGHT (LBS)
Spill Guard Assembly			
60" spill guard for utility bucket		111676	26
66" spill guard for utility bucket		108875	28
72" spill guard for utility bucket		107530	30
Bolt-on Edge Assembly			
60" bolt-on edge assembly for utility bucket		15025	124
66" bolt-on edge assembly for utility bucket		15027	110
72" bolt-on edge assembly for utility bucket		15028	150
Tooth Bar Assembly			
66" tooth bar (standard)		33822	90
66" tooth bar (over bolt-on edge)		16987	116
72" tooth bar (standard)		33823	100
72" tooth bar (over bolt-on edge)		16988	130
CONSTRUCTION BUCKET OPTIONS		ORDER CODE	SHIP WEIGHT (LBS)
Spill Guard Assembly			
72" spill guard for construction bucket		107530	30
78" spill guard for construction bucket		108880	33
84" spill guard for construction bucket		108883	35
Bolt-on Edge Assembly			
72" bolt-on edge assembly		15028	150
78" bolt-on edge assembly		16204	130
84" bolt-on edge assembly		16183	240
Tooth Bar Assembly side cutter hole mounting (construction only)			
72" side cutter mounting tooth bar assembly (standard)		110738	100
72" over the edge side cutter mounting tooth bar (over bolt-on edge)		110744	130
78" side cutter mounting tooth bar assembly (standard)		110740	109
78" over the edge side cutter mounting tooth bar (over bolt-on edge)		110746	132
84" side cutter mounting tooth bar assembly (standard)		110742	129
84" over the edge side cutter mounting tooth bar(over bolt-on edge)		110748	147
side cutter assembly (construction ONLY)		107786	18

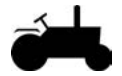

4-IN-1 MULTI-PURPOSE BUCKETS CONT.

4-IN-1 MULTI-PURPOSE BUCKETS FOR COMPACT TRACTORS

COMPACT TRACTORS	ORDER CODE	SHIP WEIGHT (LBS)
60" 4-in-1 bucket with universal hitch	108196	380
72" 4-in-1 bucket	108198	430

4-IN-1 MULTI-PURPOSE BUCKETS FOR TRACTOR LOADERS/BACKHOES



TRACTOR LOADER / BACKHOE MOUNTS	ORDER CODE	SHIP WEIGHT (LBS)	
1.25 YD			
Cat IT/TH	edge group A	11069	1920
Cat IT/TH 90" wide		11582	1920
JCB Q-fit	edge group B	11066	1920
John Deere 310D/410D pin mount	edge group B	12612	1570
Komatsu WB140	edge group B	12478	1600
1.50 YD			
JCB 214 Q-fit 96" wide with edge		12891	1820
New Holland LB 90/110 pin mount	edge group B	12520	1765
New Holland LB115 pin mount	edge group B	312861	1765
Komatsu WB 1401150 TLB	edge group B	12908	1700

4-IN-1 MULTI-PURPOSE BUCKETS FOR WHEEL LOADERS



WHEEL LOADERS	ORDER CODE	SHIP WEIGHT (LBS)	
1.00 YD			
Komatsu WA75-3		108660	1550
Wacker WL50 80" wide with edge		13236	1575
1.25 YD			
Cat IT/TH	edge group A	11069	1920
JCB 411HT	edge group B	11061	1570
JCB 411 Pin-on with edge		12823	1920
1.50 YD			
JCB 409B 84" wide (serial #130-2000 and higher)	edge group 18057	13229	1750
2.00 YD			
JCB 416 HT with edge		12774	2500
JCB 416	edge group 313851	13307	2500
2.25 YD			
blank no mounts 106" wide includes bolt-on edge kit		101769	2550
CAT IT 96" wide with edge		12374	3000
2.50 YD			
Cat IT14/IT24/IT28 106" wide with edge		12320	3200

BUCKETS

BUCKET ACCESSORIES AND ADD-ONS

BUCKET ACCESSORIES AND ADD-ONS FOR SKID-STEER LOADERS



FINISH WELDING OF MOUNTINGS MAY BE REQUIRED AFTER MOUNTING IS WELDED TO THE ATTACHMENTS. ADDITIONAL GUSSETS MAY BE REQUIRED WHEN WELDING TO CERTAIN ATTACHMENTS.

WELD-ON BUCKET EDGE & END PIECES	ORDER CODE	SHIP WEIGHT (LBS)
.375" x 3" Single Bevel Weld-On Edge	RSB0383	0.3
.50" x 4" Single Bevel Weld-On Edge	RSB0504	0.6
.75" x 6" Single Bevel Weld-On Edge	RSB0756	14
1.0" x 8" Single Bevel Weld-On Edge	RSB1008	2
.50" x 4" End Piece for Bucket - Left Hand	LAF9756-0000	3
.50" x 4" End Piece for Bucket - Right Hand	LAF9757-0000	3
.75" x 6" End Piece for Bucket - Left Hand	LAF9937-0000	6
.75" x 6" End Piece for Bucket - Right Hand	LAF9938-0000	6

REVERSIBLE CUTTING EDGE *DRILLED FOR FFC BOLT-ON EDGE (HOLES SPACED 6" APART, CENTER TO CENTER)	ORDER CODE	SHIP WEIGHT (LBS)
.75" x 8" reversible edge with 13/16" holes spaced 6" apart	RDB0758	19
.75" x 2.5" Grade 8 plow bolts with lock washers and nut	LAF9737-0000	NA

FORK POCKET BUCKET



FORK POCKET BUCKETS FOR TRACTOR LOADERS/BACKHOES AND WHEEL LOADERS

FORK POCKET BUCKET	ORDER CODE	SHIP WEIGHT (LBS)
fork pocket bucket 96" 1.5 yd	11082	1000

HEAVY-DUTY CONSTRUCTION/INDUSTRIAL BUCKETS



- Designed for leveling, digging and loading dirt, rock and other abrasive material
- Constructed with stronger material and heavy-duty wear edges or optional teeth for penetration
- 83" and 98" models for general purpose work
- .75" x 6" wear-resistant Pacal steel tapered cutting edge
- Reversible cutting edge available

Carrier Specifications	
Lift Capacity	Operating Weight
<10,000 lbs.	<32,000 lbs.

Specifications							
Model	Weight (approx)	Width OD	Height A	Depth B	Leading Edge C	Capacity Struck	Capacity Heaped
LAF3382	830 lbs	83"	32.2"	26.8"	26.8"	0.93 yd ³	1.11 yd ³
LAF 3390	863 lbs	92"	32.2"	26.8"	26.8"	1.03 yd ³	1.23 yd ³
LAF3396	939 lbs	98"	35.6"	30.0"	9.6"	1.27 yd ³	1.52 yd ³
LAF3397	1009 lbs	98"	38.6"	35.8"	12.4"	1.65 yd ³	1.99 yd ³

HEAVY-DUTY CONSTRUCTION/INDUSTRIAL BUCKETS FOR TRACTOR LOADERS/BACKHOES



INCLUDES: BUCKET AND UNIVERSAL SSL MOUNTING TO COMPLETE A BUCKET ASSEMBLY: CHOOSE A BUCKET AND MOUNTING

BUCKET		ORDER CODE	SHIP WEIGHT (LBS)
CHECK LOADER CAPACITY BEFORE ORDERING			
83" OD Construction/Industrial Bucket		LAF3382	830
92" OD Construction/Industrial Bucket		LAF3390	863
98" OD Construction/Industrial Bucket		LAF3396	939
98" OD Extra Capacity Construction/Industrial Bucket		LAF3397	1009
OPTIONAL - REVERSIBLE CUTTING EDGE KIT		ORDER CODE	SHIP WEIGHT (LBS)
INCLUDES BOE, GRADE 8 PLOW BOLTS, LOCK WASHERS & NUTS			
For Bucket LAF3382 (9 holes, 9.75" spacing)*		15029	133
For Bucket LAF3390 (9 holes, 10.82" spacing)*		309996	143
For Bucket LAF3396 (9 holes, 10.82" spacing)*		114197	155
For Bucket LAF3397 (9 holes, 10.82" spacing)*		114197	155

For Optional Bolt-On Edge Drill Patterns (i.e. Case Hole Patterns) - Call (833) 723-1843

OPTIONS - TOOTHBAR		ORDER CODE	SHIP WEIGHT (LBS)
EXCLUSIVE TO FFC BUCKETS			
Heavy-Duty Toothbar for Buckets without Bolt-On Edge			
For Bucket LAF3382 with 10 teeth		10565	150
For Bucket LAF3390 with 10 teeth		10585	157
Heavy-Duty Toothbar for Buckets with Bolt-On Edge			
For Bucket LAF3396 and LAF3397 with 10 teeth		10604	196

BUCKETS

HEAVY-DUTY CONSTRUCTION/INDUSTRIAL BUCKETS CONT.

HEAVY-DUTY CONSTRUCTION/INDUSTRIAL BUCKETS FOR WHEEL LOADERS



INCLUDES: BUCKET AND UNIVERSAL SSL MOUNTING
TO COMPLETE A BUCKET ASSEMBLY: CHOOSE A BUCKET AND MOUNTING

BUCKET	ORDER CODE	SHIP WEIGHT (LBS)
CHECK LOADER CAPACITY BEFORE ORDERING		
83" OD Construction/Industrial Bucket	LAF3382-0733	830
92" OD Construction/Industrial Bucket	LAF3390-0733	863
98" OD Construction/Industrial Bucket	LAF3396-0733	939
98" OD Extra Capacity Construction/Industrial Bucket	LAF3397-0733	1009

OPTIONS - TOOTHBAR	ORDER CODE	SHIP WEIGHT (LBS)
EXCLUSIVE TO FFC BUCKETS		
Heavy-Duty Toothbar for Buckets with Bolt-On Edge		
For Bucket LAF3396 and LAF3397 with 10 teeth	10604	196

HEAVY-DUTY GENERAL PURPOSE BUCKETS



HEAVY-DUTY GENERAL PURPOSE BUCKETS FOR TRACTOR LOADERS/BACKHOES



INCLUDES: BUCKET AND MOUNT UNLESS NOTED BUCKETS ARE 96" WIDE

TRACTOR LOADER / BACKHOE MOUNT		ORDER CODE	SHIP WEIGHT (LBS)
1.0 YD BUCKET			
Cat IT/TH 80" wide	edge group F	12649	961
Cat IT/TH 72" wide	edge kit 309610	12671	900
Ford 545 pin-on		11082	1000
JCB Q-fit 85" wide		12809	1000
1.25 YD BUCKET			
JCB Q-fit	edge group B	12329	1050
1.50 YD BUCKET			
Cat IT/TH 96" wide	edge group A	11080	1250
Cat IT/TH 84" wide	edge group D	11092	1250
1.75 YD BUCKET			
Case 680L pin on	edge group B	12422	1290
Cat IT/TH	edge group A	11107	1110
JCB 210 / 212S 90" wide	edge group 317900	12642	950
JCB Q-fit	edge group B	12770	1290
New Holland LB115 direct mount	edge group B	12334	1290
2.00 YD BUCKET			
JCB 214 pin mount 85" wide		11559	1290
2.25 YD BUCKET			
Cat IT/TH	edge group A	11182	1491
JCB 214-217 pin mount 1.66 yd struck	edge kit B	11186	1491
2.50 YD BUCKET			
Case 570-580L/super M (Pin-On Mount)	edge group B	12902	1550
Cat IT/TH	edge group A	11210	1425
JCB 214-217S pin mount 96" wide	edge group A	12796	1410

TRACTOR LOADER / BACKHOE MOUNTS CONTINUED NEXT PAGE

BUCKETS

BUCKETS

HEAVY-DUTY GENERAL PURPOSE BUCKETS CONT.

HEAVY-DUTY GENERAL PURPOSE BUCKETS FOR TRACTOR LOADERS/BACKHOES CONT.

OPTIONS - BUCKET CUTTING EDGES		ORDER CODE	SHIP WEIGHT (LBS)
TRACTOR LOADER/BACKHOE			
Group A - .75" x 10" x 96", CAT 9U9665 style, 2 pc. edge group with hardware	12 holes	14611	225
Group B - .75" x 8" x 96" overall with hardware	9 holes	11002	160
Group C - .75" x 6" x 90.63" overall with hardware	8 holes	12297	135
Group D - .75" x 8" x 84" overall with hardware	9 holes	18057	170
Group E - .75" x 8" x 82" overall with hardware	7 holes	17718	160
Group F - .75" x 8" x 79.5" overall with hardware	7 holes	309995	155
Group G - .75" x 8" x 92.5" overall with hardware	9 holes	309996	155
Group H - .75" x 8" x 102" overall JBC 3 piece edge with hardware	9 holes	12676	195
EDGE GROUPS			
Edge Group (6 holes total) - .75" x 8" x 66"		18682	130
Edge Group (7 holes total)- .75" x 8" x 61"		15025	124
Edge Group (7 holes total) - .75" x 8" x 73"		15028	150
Edge Group (7 holes total) - .75" x 8" x 74"		100831	150
Edge Group (7 holes total)- .75" x 8" x 77"		14989	155
Edge Group (7 holes total) - .75" x 8" x 78"		12597	165
Edge Group (8 holes total) - .75" x 8" x 85"		12812	170
Edge Group (9 holes total) - .75" x 8" x 90"		12286	180
Edge Group (15 holes total) - 1.0" x 10" x 106"		32950	250

HEAVY-DUTY GENERAL PURPOSE BUCKETS FOR WHEEL LOADERS



WHEEL LOADERS		ORDER CODE	SHIP WEIGHT (LBS)
.50 YD BUCKET			
Cat 902/906/908 46" wide with edge		12747	600
Cat 902/906/906 66" wide edge 18682 not included		12683	709
JCB 407B 54" wide includes edge		11015	583
Komatsu WA75/85/95 66" wide edge kit 18682 optional		12546	60
.75 YD BUCKET			
Volvo L30 77" wide	edge kit 14989	12804	568
WHEEL LOADERS CONTINUED NEXT PAGE			

HEAVY-DUTY GENERAL PURPOSE BUCKETS CONT.

HEAVY-DUTY GENERAL PURPOSE BUCKETS FOR WHEEL LOADERS CONT.

WHEEL LOADERS	ORDER CODE	SHIP WEIGHT (LBS)
1.0 YD BUCKET		
Case 221E 60" wide with edge	13261	970
Cat IT/TH 72" wide	edge group 15028	13221
Cat IT/TH 72" wide with edge	12671	900
Cat IT/TH 80" wide with edge	edge group F	12649
Furukawa w/universal hitch 72" wide	edge group 12504	11058
JCB 407/409BZX 77" wide	edge kit 14989	12388
JCB 407/409BZX 85" wide 1.00 yd	11051	900
JCB 407/409BZX 96" wide 1.12 yd	12315	900
JCB 409B 77" wide (serial # 130-22009 and higher)	edge kit 14989	13162
JCB 411-72" wide with edge	edge kit 309610	12671
JCB 416HT 72" wide mulch bkt with edge	edge group 309610	12663
New Holland LW 80 with QA 60" wide	12785	940
New Holland LW-80 with QA 72" wide	12424	960
TCM 820 76.8" wide	15207	800
Volvo L30-L35 60" wide with edge	12787	970
Volvo L40 60" wide with edge	13054	650
Volvo L40-120 77" wide	edge kit 14989	13248
1.25 YD BUCKET		
Atlas 70" wide	12282	900
TCM E806 66.5" wide	15206	800
1.50 YD BUCKET		
Cat IT/TH 96" wide	edge group A	11080
Cat IT/TH 84" wide	edge group D	11092
JCB 407/409BZX 85" wide	12372	1250
JCB 407/409BZX 77" wide with edge	12658	1044
1.75 YD BUCKET		
Cat IT/TH	11107	1110
JCB 409B 84" wide (serial # 130-2000 and higher)	edge group 14989	13238
Wacker 750T/418/850	edge group 18057	13249
JCB 409BZX with edge	12645	1070
2.0 YD BUCKET		
Cat 902 / 906 / 908 with skid-steer mount	edge group A	12573
Case 221D / 321D 78"	edge group 12597	12942
JCB 407/408/409A 78"	edge group 12597	12717
New Holland LW-70 / LW-80 78"	edge group 12597	12942

WHEEL LOADERS CONTINUED NEXT PAGE

BUCKETS

HEAVY-DUTY GENERAL PURPOSE BUCKETS CONT.

HEAVY-DUTY GENERAL PURPOSE BUCKETS FOR WHEEL LOADERS CONT.

WHEEL LOADERS CONT.		ORDER CODE	SHIP WEIGHT (LBS)
2.25 YD BUCKET			
Cat IT/TH	edge group A	11182	1491
2.50 YD BUCKET			
Cat IT/TH	edge group A	11210	1425
2.60 YD BUCKET			
Cat IT/TH 42" ext spill guard	edge group A	12258	1663
2.75 YD BUCKET			
Cat IT/TH	edge group A	306197	1670
3.00 YD BUCKET			
Cat IT/TH	edge group A	12271	1700
Volvo L40-L45	edge group B	13166	1650
3.25 YD BUCKET			
Cat IT/TH	edge group A	15202	1210
4.00 YD BUCKET			
Cat IT/TH	edge group A	11276	1800
Cat IT/TH light material high visibility	edge group A	12423	1783
JCB Q-fit light material high visibility	edge group B	12708	1727

OPTIONS - BUCKET CUTTING EDGES*		ORDER CODE	SHIP WEIGHT (LBS)
WHEEL LOADER MOUNTS			
Group A - .75" x 10" x 96", CAT 9U9665 style, 2 pc. edge group with hardware	12 holes	14611	225
Group B - .75" x 8" x 96" overall with hardware	9 holes	11002	160
Group C - .75" x 6" x 90.63" overall with hardware	8 holes	12297	135
Group D - .75" x 8" x 84" overall with hardware	9 holes	18057	170
Group E - .75" x 8" x 82" overall with hardware	7 holes	17718	160
Group F - .75" x 8" x 79.5" overall with hardware	7 holes	309995	155
Group G - .75" x 8" x 92.5" overall with hardware	9 holes	309996	155
Group H - .75" x 8" x 102" overall JBC 3 piece edge with hardware	9 holes	12676	195
EDGE GROUPS			
Edge Group (6 holes total) - .75" x 8" x 66"		18682	130
Edge Group (7 holes total)- .75" x 8" x 61"		15025	124
Edge Group (7 holes total) - .75" x 8" x 73"		15028	150
Edge Group (7 holes total) - .75" x 8" x 74"		100831	150
Edge Group (7 holes total)- .75" x 8" x 77"		14989	155
Edge Group (7 holes total) - .75" x 8" x 78"		12597	165
Edge Group (8 holes total) - .75" x 8" x 85"		12812	170
Edge Group (9 holes total) - .75" x 8" x 90"		12286	180
Edge Group (15 holes total) - 1.0" x 10" x 106"		32950	250

HEAVY-DUTY MATERIAL BUCKET



- Three sizes fit wide range of applications
- Wear-resistant Pacal steel tapered cutting edge



IMPORTANT: FFC Skid-Steer buckets have a 70° angle on the back. This may increase or decrease the effective rollback and dump angles of your Skid-Steer. Specify Skid-Steer make and model when ordering.

Carrier Specifications	
Lift Capacity	Operating Weight
<5,000 lbs.	<8,000 lbs.

Specifications							
Model	Weight (approx)	Width OD	Height	Depth	Leading Edge	Capacity	Capacity Heaped
LAF0464	626 lbs	65"	29"	38"	28"	0.78 yd ³	1.00 yd ³
LAF0473	693 lbs	72"	29"	38"	28"	0.87 yd ³	1.13 yd ³
LAF0481	760 lbs	82"	29"	38"	28"	0.97 yd ³	1.26 yd ³

HEAVY-DUTY MATERIAL BUCKETS FOR SKID-STEER LOADERS



INCLUDES: BUCKET AND UNIVERSAL SSL MOUNTING TO ORDER: CHOOSE BUCKET AND MOUNT

BUCKET	ORDER CODE	SHIP WEIGHT (LBS)
CHECK LOADER CAPACITY BEFORE ORDERING		
65" OD Heavy-Duty Material Bucket	LAF0464	756
72" OD Heavy-Duty Material Bucket	LAF0473	693
82" OD Heavy-Duty Material Bucket	LAF0481	760

Price of loader mounting must be added to the attachment price

MOUNTING	ORDER CODE	SHIP WEIGHT (LBS)
ADDITIONAL COST MAY APPLY		
Contact Customer Service at (833) 723-1843		

OPTIONS	ORDER CODE	SHIP WEIGHT (LBS)
REVERSIBLE CUTTING EDGE KIT		
INCLUDES BOE, GRADE 8 PLOW BOLTS, LOCK WASHERS & NUTS		
Drilled for FFC Bolt-On Edge (Holes spaced 6" apart, center to center)		
For Bucket LAF0464* 7 holes, 10" spacing	15027	120
For Bucket LAF0473* 7 holes, 11" spacing	102236	123
For Bucket LAF0481* 9 holes, 9.75" spacing	15029	136

For Optional Bolt-On Edge Drill Patterns (i.e. Case Hole Patterns) - Call (833) 723-1843

BUCKETS

HEAVY-DUTY MATERIAL BUCKET CONT.

HEAVY-DUTY MATERIAL BUCKETS FOR SKID-STEER LOADERS CONT.

TOOTHBAR - EXCLUSIVE TO FFC BUCKETS	ORDER CODE	SHIP WEIGHT (LBS)
Standard-Duty Toothbar for Buckets with Bolt-On Edge		
For Bucket LAF0481 with 8 teeth	10558	97
Heavy-Duty Toothbar for Buckets without Bolt-On Edge		
For Bucket LAF0473 with 8 teeth	10539	126
For Bucket LAF0481 with 9 teeth	10559	141
Heavy-Duty Toothbar for Buckets with Bolt-On Edge		
For Bucket LAF0473 with 8 teeth	10540	154

FOR CUSTOM TOOTHBARS OR TOOTHBARS WITHOUT FFC BOLT-ON EDGE - CALL (833) 723-1843

HEAVY-DUTY AG LOADER TRACTOR BUCKET



- Four sizes fit wide range of loaders
- 10 gauge, reinforced wrapper
- 8" bolt-on spill guard available
- Bolt-on reversible cutting edges and tooth bars available

Carrier Specifications	
Lift Capacity	Operating Weight
<10,000 lbs.	<32,000 lbs.

Specifications							
Model	Weight (approx)	Width OD	Height	Depth	Leading Edge	Capacity Struck	Capacity Heaped
LAF2560	502 lbs	62"	24"	33"	20.75"	0.61 yd ³	0.74 yd ³
LAF2572	569 lbs	74"	24"	33"	20.75"	0.73 yd ³	0.90 yd ³
LAF2584	661 lbs	86"	24"	33"	20.75"	0.85 yd ³	1.06 yd ³
LAF2596	744 lbs	98"	24"	33"	20.75"	0.97 yd ³	1.21 yd ³

HEAVY-DUTY BUCKETS FOR AG LOADER TRACTOR



INCLUDES: BUCKET ONLY
PRICE OF LOADER MOUNTING MUST BE ADDED TO THE ATTACHMENT PRICE.

BUCKET	ORDER CODE	SHIP WEIGHT (LBS)
--------	------------	-------------------

CHECK LOADER CAPACITY BEFORE ORDERING

62" OD HD Round Utility Bucket	LAF2560-0022	502
74" OD HD Round Utility Bucket	LAF2572-0022	569
86" OD HD Round Utility Bucket	LAF2584-0022	661
98" OD HD Round Utility Bucket	LAF2596-0022	744

MOUNTING	ORDER CODE	SHIP WEIGHT (LBS)
----------	------------	-------------------

ADDITIONAL COST MAY APPLY

Contact Customer Service at (833) 723-1843

OPTIONS	ORDER CODE	SHIP WEIGHT (LBS)
---------	------------	-------------------

REVERSIBLE CUTTING EDGE KIT - INCLUDES BOE, GRADE 8 PLOW BOLTS, LOCK WASHERS & NUTS

For Bucket LAF2560 (7 holes, 9" spacing)*	114011	103
For Bucket LAF2572 (7 holes, 11" spacing)*	102236	123
For Bucket LAF2584 (9 holes, 10" spacing)*	113978	143
For Bucket LAF2596 (9 holes, 10.82" spacing)*	114197	163

For Optional Bolt-On Edge Drill Patterns (i.e. Case Hole Patterns) - Call (833) 723-1843

HEAVY-DUTY UTILITY BUCKET OPTIONS CONTINUED NEXT PAGE

BUCKETS

HEAVY-DUTY AG LOADER TRACTOR BUCKET CONT. HEAVY-DUTY BUCKETS FOR AG LOADER TRACTORS CONT.

BUCKETS

OPTIONS CONT.		
BOLT-ON SPILL GUARD PREVENTS SPILLAGE WHEN CARRYING LARGE CAPACITY LOADS	ORDER CODE	SHIP WEIGHT (LBS)
8" Spill Guard for LAF2560	LAF2562-0000	40
8" Spill Guard for LAF2572	LAF2574-0000	40
8" Spill Guard for LAF2584	LAF2586-0000	40
8" Spill Guard for LAF2596	LAF2598-0000	40
TOOTHBAR - EXCLUSIVE TO FFC BUCKETS		
	ORDER CODE	SHIP WEIGHT (LBS)
Standard-Duty Toothbar for Buckets without Bolt-On Edge		
For Bucket LAF2560 with 7 teeth	10513	65
For Bucket LAF2584 with 10 teeth	10573	90
For Bucket LAF2596 with 10 teeth	10601	96
Heavy-Duty Toothbar for Buckets without Bolt-On Edge		
For Bucket LAF2572 with 8 teeth	10539	126
For Bucket LAF2584 with 10 teeth	10575	152
For Bucket LAF2596 with 10 teeth	10603	161
Heavy-Duty Toothbar for Buckets with Bolt-On Edge		
For Bucket LAF2572 with 8 teeth	10540	154
For Bucket LAF2584 with 8 teeth	10576	175
For Bucket LAF2596 with 10 teeth	10604	196

HIGH-CAPACITY HEAVY-DUTY BUCKET

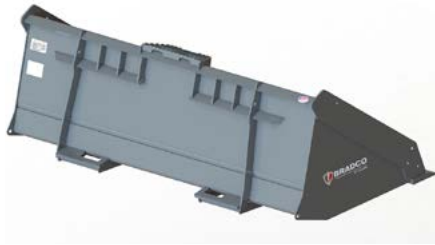

- 75", 80" & 84" with 1" cutting edge and back drag plating for strength wear protection
- Strong box sections across the top, heel, & front edge
- High tensile side plates
- Used for nursery applications, snow removal & construction

Specifications

Width	Weight (approx)	Height	Depth	Rollback Angle	Capacity Heaped
75"	633 lbs	25"	38"	20°	21 ft ³
75" *	633 lbs	25"	38"	20°	21 ft ³
80"	746 lbs	25"	38"	20°	25 ft ³
80" *	810 lbs	25"	38"	20°	25 ft ³
84"	749 lbs	25"	38"	20°	27 ft ³
84" *	813 lbs	25"	38"	20°	27 ft ³

*Bucket with 9 teeth

HIGH-CAPACITY HEAVY-DUTY BUCKETS FOR SKID-STEER LOADERS



	ORDER CODE	SHIP WEIGHT (LBS)
63" high capacity dirt bucket with bolt on teeth	121748	490
68" high capacity dirt bucket with bolt on teeth	121753	522
75" high capacity dirt bucket (21.0 ft ³) 8 holes/10.01" spacing	125784	633
75" high capacity dirt bucket with 8 teeth	125785	690
75" high capacity dirt bucket with bolt on teeth	121680	602
80" high capacity dirt bucket (24.7 ft ³) 7 holes/12" spacing	125786	746
80" high capacity dirt bucket with 9 teeth	125787	810
80" high capacity dirt bucket with bolt on teeth	121654	646
84" high-capacity dirt bucket (26.8 ft ³) 9 holes/9.75" spacing	125788	749
84" high capacity dirt bucket with 9 teeth	125789	813
84" high capacity dirt bucket with bolt on teeth	121674	670

"DIRT-READY" HIGH-CAPACITY HEAVY-DUTY BUCKETS FOR SKID-STEER LOADERS



"DIRT READY" BUCKETS INCLUDE SIDE CUTTERS AND EITHER BOE OR TEETH

	ORDER CODE	SHIP WEIGHT (LBS)
75" high capacity dirt bucket w/boe & side cutters	KD107023	772
75" high capacity dirt bucket w/teeth and side cutters	KD107024	707
80" high capacity dirt bucket w/boe & side cutters	KD113428	900
80" high capacity dirt bucket w/teeth and side cutters	KD113429	842
84" high capacity dirt bucket w/teeth and side cutters	KD18453	940
84" high capacity dirt bucket w/boe & side cutters	KD18452	970
90" high capacity dirt bucket w/teeth & side cutters	239639	875
90" high capacity dirt bucket w/boe & side cutters	239640	900
96" high capacity dirt bucket w/teeth & side cutters	239663	925
96" high capacity dirt bucket w/boe & side cutters	239664	936

BUCKETS

HIGH-CAPACITY LIGHT MATERIAL BUCKET



- .75" x 6" high carbon, beveled edge
- Optional bolt-on wear edge
- Wear plating across bottom to prevent damage on bucket floor
- Forward swept top wrap to better contain wet or loose materials



Specifications				
Width	Weight (approx)	Height	Depth	Capacity Heaped
84"	740 lbs	35"	41"	1.625 yd ³
96"	880 lbs	35"	41"	2 yd ³

HIGH-CAPACITY LIGHT MATERIAL BUCKETS FOR SKID-STEER LOADERS



HIGH-CAPACITY LIGHT MATERIAL BUCKETS	ORDER CODE	SHIP WEIGHT (LBS)
84" high capacity light material/snow bucket (1.625 yd ³) 9 holes/9.75" spacing	102191	740
96" high capacity light material/snow bucket (2 yd ³) 9 holes/10.83" spacing	102333	880

HIGH-DUMP BUCKET



- The Bradco® High-Dump bucket extends lift height by more than five feet! (60.5") compared to a standard general purpose bucket.
- The High-Dump bucket offers 113° of roll-out
- The bucket is designed for use with light-duty material
- Available in 60", 72", 84" and 96" widths

Specifications				
Width	Weight (approx)	Height	Depth	Capacity Heaped
60"	1000 lbs	32.3"	49.9"	1.00 yd ³
72"	1170 lbs	32.3"	49.9"	1.20 yd ³
84"	1275 lbs	32.3"	49.9"	1.50 yd ³
96"	1359 lbs	32.3"	49.9"	1.70 yd ³

HIGH-DUMP BUCKETS FOR SKID-STEER LOADERS

	ORDER CODE	SHIP WEIGHT (LBS)
60" High-Dump Bucket (1.00 yd ³) 7 holes/9.00" spacing	122651	1100
72" High-Dump Bucket (1.19 yd ³) 7 holes/11.00" spacing	122619	1270
84" High-Dump Bucket (1.44 yd ³) 9 holes/9.75" spacing	122657	1375
96" High-Dump Bucket (1.68 yd ³) 16 holes/6.00" spacing	122660	1459
OPTIONAL BOLT-ON CUTTING EDGE KIT INCLUDES BOE, GRADE 8 PLOW BOLTS, LOCK WASHERS & NUTS		
	ORDER CODE	SHIP WEIGHT (LBS)
60" (7 holes, 9.00" spacing)	15025	124
72" (7 holes, 11.00" spacing)	15028	150
84" (9 holes, 9.75" spacing)	16183	203
96" (16 holes, 6.00" spacing)	FFC10084	232
OPTIONS INCLUDES ½" FLAT FACE COUPLERS		
	ORDER CODE	SHIP WEIGHT (LBS)
60" hose kit	MTG1113-0022	14
80" hose kit	MTG1113-0903	18
88" hose kit	MTG1113-9783	21
96" hose kit	117285	23
*Hose Kits-Hoses from the bucket to the loader are not supplied. Hose packages available are listed above or the dealer can make up their own hoses.		

BUCKETS

LARGE FRAME SKID-STEER BUCKET



- Models for utility and dirt applications
- Higher strength and capacity for larger Skid-Steers
- Wear-resistant Pacal steel tapered cutting edge



IMPORTANT: FFC Skid-Steer buckets have a 70° angle on the back. This may increase or decrease the effective rollback and dump angles of your Skid-Steer. Specify Skid-Steer make and model when ordering.

Carrier Specifications	
Lift Capacity	Operating Weight
<9,000 lbs.	<11,000 lbs.

Specifications								
Model	Use	Weight (approx)	Width OD	Height	Depth	Leading Edge	Capacity Struck	Capacity Heaped
LAF0485	Utility	850 lbs	82.5"	31.9"	42.6"	31.3"	1.19 yd ³	1.50 yd ³
LAF0496	Utility	970 lbs	94.2"	31.9"	42.6"	31.3"	1.37 yd ³	1.73 yd ³

LARGE FRAME SKID-STEER BUCKETS FOR SKID-STEER LOADERS



INCLUDES: BUCKET AND UNIVERSAL SSL MOUNTING

BUCKET	ORDER CODE	SHIP WEIGHT (LBS)
82.5" OD Large-Frame Skid-Steer Bucket	LAF0485-0022	850
94.2" OD Large-Frame Skid-Steer Bucket	LAF0496-0022	970
OPTIONAL- REVERSIBLE CUTTING EDGE KIT INCLUDES BOE, GRADE 8 PLOW BOLTS, LOCK WASHERS & NUTS	ORDER CODE	SHIP WEIGHT (LBS)
For Bucket LAF0485 (9 holes, 9.75" spacing)*	15029	136
For Bucket LAF0496 (9 holes, 10.82" spacing)*	113984	157
OPTIONAL- TOOTHBARS EXCLUSIVE TO FFC BUCKETS	ORDER CODE	SHIP WEIGHT (LBS)
Heavy-Duty Toothbar for Buckets without Bolt-On Edge		
For Bucket LAF0485 with 10 teeth	10561	150
Heavy-Duty Toothbar for Buckets with Bolt-On Edge		
For Bucket LAF0496 with 10 teeth	10590	193
Extra Heavy-Duty Toothbar for Buckets with Bolt-On Edge		
For Bucket LAF0485 with 10 teeth	10564	183
For Bucket LAF0496 with 10 teeth	10592	191

LIGHT MATERIAL LOADER BUCKETS



LIGHT MATERIAL LOADER BUCKETS FOR COMPACT TRACTOR LOADERS WITH SKID-STEER LOADER INTERCHANGE



BUCKET	ORDER CODE	SHIP WEIGHT (LBS)
66" light material loader bucket* - heaped capacity .55yd ³ , struck capacity .43yd ³	13426	450
72" light material loader bucket* - heaped capacity .61yd ³ , struck capacity .48yd ³	307092	595
78" light material loader bucket* - heaped capacity .72yd ³ , struck capacity .55yd ³	120897	614
84" light material loader bucket* - heaped capacity .78yd ³ , struck capacity .60yd ³	120903	653

*Includes bolt-on edge

BUCKETS

ROCK BUCKETS

NEW PRODUCT



- Reinforced tine tips resist bending from side loads
- Collect rocks, bricks & debris allowing the soil to sift through
- Removable bolt-in side plates for handling logs
- Grade 80 tine construction
- Bolt-in side plates
- Optional grapple kit (239600) to secure large loads (coming soon)

Carrier Specifications	
Lift Capacity	Operating Weight
<9,000 lbs.	<13,000 lbs.

Specifications						
Weight (approx)	Width OD	Height	Depth	Number of Tines	Tine Spacing	Tine Thickness
514 lbs	60"	22.5"	43.8"	19	3"	0.375"
559 lbs	66.63"	22.5"	43.8"	21	3"	0.375"
599 lbs	73.25"	22.5"	43.8"	23	3"	0.375"
670 lbs	79.88"	22.5"	43.8"	25	3"	0.375"
711 lbs	86.5"	22.5"	43.8"	27	3"	0.375"

ROCK BUCKETS FOR SKID-STEER LOADERS



INCLUDES: BUCKET, SIDE PLATES, AND MOUNTING

UNIVERSAL SKID-STEER MOUNT	ORDER CODE	SHIP WEIGHT (LBS)
60" bucket, 3" tine spacing	32260-0022	534
66" bucket, 3" tine spacing	32266-0022	579
72" bucket, 3" tine spacing	32272-0022	619
78" bucket, 3" tine spacing	32278-0022	690
84" bucket, 3" tine spacing	32284-0022	731
OPTIONS	ORDER CODE	SHIP WEIGHT (LBS)
replacement side plate kit (2 plates + hardware)	239509	30

ROCK BUCKETS CONT.



- Available with or without single piece construction universal mount
- Optional bolt-on universal skid-steer and tractor mounts available
- Offers maximum production & covers typical wheel bases
- Collect rocks, bricks & debris allowing the soil to sift through
- Optional 60" grapple kit for 1.13 diameter tines, opens to 55"

Carrier Specifications	
Lift Capacity	Operating Weight
<10,000 lbs.	<32,000 lbs.

Specifications						
Weight (approx)	Width OD	Height	Depth	Number of Tines	Tine Spacing	Tine Diameter
680 lbs	66"	22"	43"	22	2"	1.13"
555 lbs	66"	22"	43"	16	3"	1.13"
742 lbs	75"	22"	43"	24	2"	1.13"
625 lbs	75"	22"	43"	18	3"	1.13"
692 lbs	84"	22"	43"	20	3"	1.13"

ROCK BUCKETS FOR SKID-STEER LOADERS



INCLUDES: BUCKET AND MOUNTING

UNIVERSAL SKID-STEER MOUNT	ORDER CODE	SHIP WEIGHT (LBS)
66" bucket, 2" tine spacing	16294	680
66" bucket, 3" tine spacing	89627	555
75" bucket, 2" tine spacing	16297	742
75" bucket, 3" tine spacing	89646	625
84" bucket, 3" tine spacing	16503	692
OPTIONS		
Grapple Assembly	ORDER CODE	SHIP WEIGHT (LBS)
grapple assembly for Skid-Steer mounts	104950	490
Hydraulic Kit for Grapple		
75" hoses with flat face couplers	105845	13
87" hoses with flat face couplers	105712	15

ROCK BUCKETS FOR EURO/GLOBAL MOUNTS



PRICE INCLUDES: BUCKET AND MOUNTING

EURO/GLOBAL MOUNTS	ORDER CODE	SHIP WEIGHT (LBS)
75" rock bucket with euro / global mount, 2" tine spacing	111771	635
75" rock bucket with euro / global mount, 3" tine spacing	111772	516
84" rock bucket with euro / global mount, 3" tine spacing; heavy duty tine	111773	1480
93" rock bucket with euro / global mount, 3" tine spacing; heavy duty tine	111774	1658
OPTIONS		
Hydraulic Kit for Grapple	ORDER CODE	SHIP WEIGHT (LBS)
75" hoses with flat face couplers	105845	13
87" hoses with flat face couplers	105712	15

BUCKETS

ROCK BUCKETS CONT.

ROCK BUCKETS FOR COMPACT TRACTORS



INCLUDES: BUCKET AND MOUNTING

COMPACT TRACTOR MOUNTS	ORDER CODE	SHIP WEIGHT (LBS)
55" rock bucket 2" tine spacing	108603	300

ROCK BUCKETS FOR WHEEL LOADERS



INCLUDES: BUCKET AND MOUNTING

SWHEEL LOADER MOUNTS	ORDER CODE	SHIP WEIGHT (LBS)
84" Rock Bucket 3" tine spacing, 1.62" diameter tines		
Case 570K pin-on	105021	1688
Case 570L/570M/570N	119796	1688
Case 680	12934	1705
Cat IT/TH 84" wide 3" tine spacing	102123	1725
John Deere 840	12898	1540
John Deere 244J	13231	1795
New Holland LW-50	12834	1800
Volvo L30-L35	13231	1795
FFC QCP 7000 MTG 84" x 1.63" tine spacing	114356	1626
94" Rock Bucket		
JCB 214 pin-on	12810	1900

ROCK BUCKETS NO MOUNT



INCLUDES: BUCKET ONLY

BUCKET ONLY	ORDER CODE	SHIP WEIGHT (LBS)
66" bucket, 2" tine spacing no mount	16354	675
66" bucket, 3" tine spacing no mount	89666	550
75" bucket, 2" tine spacing no mount	16356	736
75" bucket, 3" tine spacing no mount	89675	619
84" bucket, 3" tine spacing no mount	16501	651
OPTIONS	ORDER CODE	SHIP WEIGHT (LBS)
Hydraulic Kit for Grapple		
75" hoses with flat face couplers	105845	13
87" hoses with flat face couplers	105712	15
BOLT-ON MOUNT	ORDER CODE	SHIP WEIGHT (LBS)
bolt-on universal Skid-Steer mount no pins	88730	99
bolt-on universal loader mount 1.00" diameter pin	88732	99
bolt-on universal loader mount 1.25" diameter pin	102503	99

COLD PLANERS



COLD PLANERS

COLD PLANER



- Planetary drive delivers high torque
- High rear spoil clearance to prevent recirculation of material
- Protective shields for hydraulic & electrical components
- Efficient piston drive motor
- Optional water tank available with adjustable mounting brackets to fit most skid-steer loaders

Carrier Specifications

Lift Capacity	Operating Weight
<10,000 lbs.	<20,000 lbs.

Specifications

Model #	Weight (Approx)	Hydraulic Flow	Flow Range	Overall Width	Overall Height	Planing Width	Planing Depth
SP300	1500 lbs	standard	12-22 gpm	52"	32"	12"	0"-5"
HP400	2175 lbs	high	22-40 gpm	65"	35"	16"	0"-5"
HP450	2200 lbs	high	22-40 gpm	65"	35"	18"	0"-5"
HP600	2400 lbs	high	22-40 gpm	65"	35"	24"	0"-5"
HP750	2600 lbs	high	22-40 gpm	65"	35"	30"	0"-5"
HP1000	3100 lbs	high	31-40 gpm	65"	35"	40"	0"-5"

COLD PLANER FOR SKID-STEER LOADERS



TO ORDER: CHOOSE AN ASSEMBLY, MOTOR, OEM IN-CAB CONTROL AND COUPLERS (QD SET). HOSES ARE INCLUDED. CONTACT FACTORY FOR INFORMATION ON DIRECT CONNECT TO SKID-STEER (833) 723-1843

COLD PLANER ASSEMBLY

ORDER CODE SHIP WEIGHT (LBS)

Standard Flow 12 - 22 GPM

SP300 12" hydraulic side-shift/mechanical tilt/depth (complete - controls not required)	101197	1450
SP300 12" hydraulic side-shift/tilt/depth (complete with control handle assembly 118650)	101196	1500

Four Function In-Cab, High Flow (requires hydraulic motor)

HP400 16" hydraulic side-shift/tilt/depth (18" frame)	100793	2175
HP450 18" hydraulic side-shift/tilt/depth	100265	2200
HP600 24" hydraulic side-shift/tilt/depth	100266	2400
HP750 30" hydraulic side-shift/tilt/depth	100267	2600
HP1000 40" hydraulic side-shift / tilt / depth (requires motor P/N 17778)	103030	3100

Three Function In-Cab (right depth, left depth, sideshift) with Selector Valve on Planer (changes side-shift to tilt), High Flow (requires hydraulic motor)

HP400 16" hydraulic side-shift/tilt/depth (18" frame)	114436	2175
HP450 18" hydraulic side-shift/tilt/depth	114437	2220
HP600 24" hydraulic side-shift/tilt/depth	114438	2400
HP750 30" hydraulic side-shift/tilt/depth	114439	2600
HP1000 40" hydraulic side-shift / tilt / depth (requires motor P/N 17778)	114440	3100

HYDRAULIC MOTOR

ORDER CODE SHIP WEIGHT (LBS)

22 to 25 GPM hydraulic motor	17776	25
26 to 30 GPM hydraulic motor	17777	21
31 to 44 GPM hydraulic motor	17778	25

COLD PLANER FOR SKID-STEER LOADERS CONT.

OEM IN-CAB CONTROLS	ORDER CODE	SHIP WEIGHT (LBS)
4 Function High Flow Planers Only		
Bobcat 7-pin - Pilot (12 button) controls	07-9548 + 239039	
Bobcat 7-pin - Toolcat, Verahandler, and Hand/Foot controls	07-9602 + 114874	
Bobcat, Ditch Witch, Gehl, Mustang, JCB, Volvo	114874	1
CNH, Kubota SVL Series 2, Kubota SSV-2	116745	1
John Deere	114969	1
John Deere P-Series	239596	1
Kubota (must have the Kubota Multi-Function Control Kit), JCB, Volvo, Takeuchi	118470	1
Bradco Control Handle Assembly	115403	15
CAT D-Series	120262	1
3 Function with Selector Valve High Flow Planers Only		
Bobcat, CNH, Gehl, JCB, Mustang, Volvo, Wacker	19644	1
John Deere	108618	1
Kubota (must have the Kubota Multi-Function Control Kit)	19644	1
Bradco Control Handle Assembly	118650	15
Takeuchi	120337	1
CAT D-Series	122128	1
Q.D. SETS	ORDER CODE	SHIP WEIGHT (LBS)
0.50" body with 0.38" Male Drain	119996	5
0.50" body with 0.38" Female Drain	119997	5
0.62" body with 0.38" Male Drain	119998	5
0.62" body with 0.38" Female Drain	119999	5
0.75" body with 0.25" Male Drain	120000	5
0.75" body with 0.38" Male Drain	120001	5
0.75" body with 0.38" Female Drain	120002	5
0.75" body with 0.50" Male Drain	120003	5
OPTIONS	ORDER CODE	SHIP WEIGHT (LBS)
30 gal. Universal Mount Tank, 12V pump with out electrical control box	105720	60
30 gal. Universal Mount Tank, 12V pump with electrical control box	104444	65
2.5" standard flow slot cutter	100641	90
2.5" high flow slot cutter	100642	120
4" high flow slot cutter	100643	135
6" high flow slot cutter	100644	150
Hose Extension Kit	119419	10
REPLACEMENT PARTS	ORDER CODE	SHIP WEIGHT (LBS)
Pick Replacement Kit, RP18 12" Drum (37 Picks)	120708	
Pick Replacement Kit, RP18 18" Drum (45 Picks)	120702	
Pick Replacement Kit, RP18 24" Drum (57 Picks)	120704	
Pick Replacement Kit, RP18 30" Drum (69 Picks)	120706	
Pick Replacement Kit, RP18 40" Drum (89 Picks)	123827	
Pick Replacement Kit, G.p. (100 Picks)	107013	
Pick Replacement Kit, Concrete (100 Picks)	107012	
Pick Replacement Kit, G.p. (50 Picks)	102058	30
Pick Replacement Kit, Concrete (50 Picks)	102059	30
REPLACEMENT PARTS CONTINUED NEXT PAGE		

COLD PLANERS

COLD PLANER FOR SKID-STEER LOADERS CONT.

REPLACEMENT PARTS	ORDER CODE	SHIP WEIGHT (LBS)
Pick General Purpose	18546	
Pick Concrete	18547	
Pick Asphalt RP18	LAF9390-0000	
Puller, Pick Extracting Tool- 1761401	100213	
12" Standard Drum Assembly-Incl Standard General Purpose Picks	19706	155
16" High Flow Drum Assembly-Incl Standard General Purpose Picks	18534	335
18" High Flow Drum Assembly-Incl Standard General Purpose Picks	18535	350
24" High Flow Drum Assembly-Incl Standard General Purpose Picks	18524	400
30" High Flow Drum Assembly-Incl Standard General Purpose Picks	19712	660
40" High Flow Drum Assembly-Incl Standard General Purpose Picks	101080	720
Electric Control Box	15757	5
Replacement Electric Control Handle	100434	15
Motor 2.00 Cid 15t 2bolt-B (22-25 Gpm)	17776	
Motor 2.48 Cid 15t 2bolt-B (26-30 Gpm)	17777	
Motor 3.00 Cid 15t 2bolt-B (31-44 Gpm)	17778	
Seal Kit, Motor - All Motors	45845	

COLD PLANER SERIES II



- Side shifts 24" left or right to cut next to obstacles
- High flow models feature planetary gearbox drive for increased torque and durability
- Two sizes available for standard-flow Skid-Steers, six sizes available for high-flow Skid-Steers

Carrier Specifications	
Lift Capacity	Operating Weight
<10,000 lbs.	<20,000 lbs.



NOTE: All replacement hydraulic hoses and fittings must have a minimum rated working pressure of 4000 PSI.

Specifications									
Model #	Flow	Weight (Approx)	Cutting Width	Cutting Depth	Tilt	Sideshift	Pick Qty.	PSI Range	GPM Range
LAF5412	Std	1135 lbs	12"	0-5.00"	±15°	24"	36	2200-3400	13-25
LAF5413	Std	1225 lbs	16"	0-5.00"	±15°	24"	44	2200-3400	16-25
LAF5416	High	1510 lbs	16"	0-6.00"	±15°	24"	48	2200-5000	24-45
LAF5418	High	1560 lbs	18"	0-6.00"	±15°	24"	52	2200-5000	26-45
LAF5420	High	1610 lbs	20"	0-6.00"	±15°	24"	56	2200-5000	26-45
LAF5424	High	1690 lbs	24"	0-6.00"	±15°	24"	64	2200-5000	28-45
LAF5430	High	1855 lbs	30"	0-6.00"	±12.5°	24"	76	2200-5000	28-45
LAF5436	High	2015 lbs	36"	0-6.00"	±10°	24"	88	2200-5000	31-45

COLD PLANER SERIES II CONTINUED NEXT PAGE

COLD PLANER SERIES II CONT.

COLD PLANER SERIES II FOR SKID-STEER LOADERS CONT.



INCLUDES: COLD PLANER, UNIVERSAL SSL MOUNTING AND CONTROL BOX. HOSES AND COUPLERS INCLUDED FOR SKID-STEERS ONLY. TO ORDER CHOOSE COLD PLANER, MOUNT AND OEM IN-CAB CONTROLS.

COLD PLANER		ORDER CODE	SHIP WEIGHT (LBS)
CHECK LOADER CAPACITY BEFORE ORDERING			
Standard-Flow Cold Planer			
12" Standard-Flow Cold Planer (manual tilt, depth, and side shift adjustment)	LAF5412-0022		1235
16" Standard-Flow Cold Planer (manual tilt, depth, and side shift adjustment)	LAF5413-0022		1325
High-Flow Cold Planer (To be used on High-Flow SSL Loaders. Call FFC for availability)			
16" High-Flow Cold Planer	LAF5416-0022		1610
18" High-Flow Cold Planer	LAF5418-0022		1660
20" High-Flow Cold Planer	LAF5420-0022		1710
24" High-Flow Cold Planer	LAF5424-0022		1780
30" High-Flow Cold Planer	LAF5430-0022		1955
36" High-Flow Cold Planer	LAF5436-0022		2115
OEM IN-CAB CONTROLS		ORDER CODE	SHIP WEIGHT (LBS)
FFC 3-Line Cold Planer Electrical Controls			
Standard Control Box	07-10013		1
Wire Harness (multi function in cab controls) for CNH, JCB, Bobcat, Mustang, Kubota, Takeuchi, Volvo 14 Pin-8 Pin	LAF9360-0000		1
Wire harness for CNH (8-pin rectangular)	LAF9393		1
Caterpillar D XPS (14-pin)	07-8373		1
Caterpillar D XHP (14-pin)	07-8378		1
John Deere pre-D with 8-button controls (14-pin)	LAF9361		1
John Deere with EH controls & D/E series (14-pin)	07-7626		1
Kubota (must have the Kubota Multi-Function Control Kit)	19644		1
FFC 5-Line Cold Planer Electrical Controls			
Standard Control Box	07-10019		15
Case (14-pin)	LAF9360-0000		15
Wire harness for CAT pre-B (8-pin Deutsch)	07-10021		15
Caterpillar B/C series (8-pin)	07-10170		15
Komatsu (8-pin)	07-10057		15
Volvo (14-pin)	LAF9360-0000		15
REPLACEMENT PARTS		ORDER CODE	SHIP WEIGHT (LBS)
Pick Asphalt RP18	LAF9390-0000		1
Pick Heavy Duty Cement	07-10005		1
Kit Bit Concrete FFC Cold Planer 4-Pack	07-10005-4		
Service Tool - Pick Removal	LAF9326-0000		5
Replacement Wheel Kit For Cold Planers	LAF5450-0000		11
Motor Char-Lynn 24 Cu In - Std Flow	LAF4697-0000		
Motor Piston 2.48 Cid.50 13t 2bolt-B - High Flow	03-10122		
Kit Seal F/03-10122	03-6142		
Kit Seal F/LAF4697-0000	LAF4715-0000		

CONCRETE CHUTER / CONCRETE CLAW

CONCRETE CHUTER



- Half or three-quarter yard

Specifications					
Model	Weight (approx)	Length w/o Chute	Length w/ Chute	Width	Height OD
11050	450 lbs	36"	65"	58"	28"
11075	520 lbs	39"	68"	58"	31"

CONCRETE CHUTER FOR SKID-STEER LOADERS



CONCRETE CHUTER	ORDER CODE	SHIP WEIGHT (LBS)
.5 yard Concrete Chuter	11050-0022	488
.75 yard Concrete Chuter	11075-0022	550

CONCRETE CLAW



- Excellent attachment for removing concrete on sidewalks, driveways or any construction site
- End plates and 1.5" Tooth Shank are made with high strength T-1 steel
- 1" x 8" wear resistant steel tapered cutting edge

Carrier Specifications	
Lift Capacity	Operating Weight
<10,000 lbs.	<32,000 lbs.

Specifications					
Model	Weight (approx)	Working Width	Working Depth	Rear Opening Height	Height
10024	442 lbs	24"	48"	7.5"	21"

CONCRETE CLAW FOR SKID-STEER LOADERS



i **INCLUDES: CONCRETE CLAW & UNIVERSAL SSL MOUNTING. TO ORDER CHOOSE CONCRETE CLAW AND MOUNT.**

CONCRETE CLAW	ORDER CODE	SHIP WEIGHT (LBS)
CHECK LOADER CAPACITY BEFORE ORDERING		
Concrete Claw	10024-0022	575

MOUNTING - ADDITIONAL COST MAY APPLY	ORDER CODE	SHIP WEIGHT (LBS)
Contact Customer Service at (833) 723-1843		

OPTIONAL- REPLACEABLE PARTS	ORDER CODE	SHIP WEIGHT (LBS)
Replaceable points for 1-1/2" shank (cast)	88893	3
Rubberized flex pin	88894	1

NOTE: Shipping weights vary depending on loader mounting and packaging.

COUPLER - TOOL CARRIER, QCP 7000 - MANUAL



- Maintains loader breakout, dump and rollback
- Change attachments quickly and easily with the 4-point hook-up system
- Allows clear line of site; operator can see positive hook-up

Carrier Specifications	
Lift Capacity	Operating Weight
<10,000 lbs.	<32,000 lbs.

COUPLER - QCP 7000 TOOL CARRIER, MANUAL FOR TRACTOR LOADERS/BACKHOES



INCLUDES: TOOL CARRIER AND MOUNTING. HOSES AND COUPLERS INCLUDED FOR SKID-STEERS ONLY. TO ORDER CHOOSE CARRIER AND MOUNTING. FITS MOST CASE, NEW HOLLAND AND FORD TLB'S. MANUAL QUICK ATTACH ONLY AVAILABLE THROUGH FFC & HYDRAULIC QUICK ATTACH ONLY AVAILABLE THROUGH CNH

QCP 7000 TOOL CARRIER CHECK LOADER CAPACITY BEFORE ORDERING	ORDER CODE	SHIP WEIGHT (LBS)
Quick Attach Tool Carrier (Manual) F/CASE 570 L, M, N	LAF1721-0737	325
Quick Attach Tool Carrier (Manual) F/FORD 555 E STD,NH B95C	LAF1721-0892	280
Quick Attach Tool Carrier (Manual) F/FORD 555C	LAF1721-0224	280
Quick Attach Tool Carrier (Manual) F/NH LB 115, B95BTC	LAF1721-0983	280
Quick Attach Tool Carrier (Manual) F/FORD 445 C STD	LAF1721-0210	280
Quick Attach Tool Carrier (Manual) F/CASE 580 K	LAF1721-0087	280
Quick Attach Tool Carrier (Manual) QA F/CASE 580C-D-E	LAF1721-0083	280

NOTE: Other mountings available - price available upon request

MOUNTING ADDITIONAL COST MAY APPLY	ORDER CODE	SHIP WEIGHT (LBS)
Contact Customer Service at (833) 723-1843		

OPTIONS	ORDER CODE	SHIP WEIGHT (LBS)
QCP 7000 - Mounting Ears (Field Install) Required for attachments that do not have the FFC Quick Coupler Mounting		
Mounting ears to convert existing buckets and attachments	LAF1723-0000	302

NOTE: Shipping weights vary depending on loader mounting and packaging.

DOZER BLADES

DOZER BLADE



- Available in 84" and 96"
- Hydro-electric controlled angle and tilt, using only one loader valve
- Angle 30° right or left off center
- Tilt 10° off horizontal both directions
- Tilt indicator visible from operator's seat

Specifications

Weight (approx)	Overall Width	Overall Height	Overall Length	Angle left/right	Tilt
1300 lbs	84"	30"	37"	30°	10°
1400 lbs	96"	30"	37"	30°	10°

DOZER BLADES FOR SKID-STEER LOADERS



INCLUDES: DOZER BLADE. HOSES AND UNIVERSAL FLAT FACE COUPLERS INCLUDED.

DOZER BLADE	ORDER CODE	SHIP WEIGHT (LBS)
84" dozer blade	88861	1300
96" dozer blade	89681	1400

ADAPTER HARNESS FOR IN-CAB CONTROL (REQUIRES ONE OF THE BELOW)	ORDER CODE	SHIP WEIGHT (LBS)
Control box w/ power lead	28-10754	5
7-pin for Bobcat	07-9548	5
Wire Harness (multi function in cab controls) for CNH, JCB, Bobcat, Mustang, Kubota, Takeuchi, Volvo 14 Pin-8 Pin	LAF9360-0000	5
14 pin - 8 pin for CAT XPS D	119740	5
14 pin - 8 pin for CAT XHP D	119741	5
8-pin, Fits F2-H Series, for CAT B and C	07-10170	5
8-pin for Komatsu	07-10057	5
14-pin, Fits All Series, for John Deere-8 button	LAF9361	5

FLAIL MOWERS



- Cuts 4" trees and heavy brush. Can cut up to 6" trees as needed
- Engineered for maximum performance and service life
- Allows operator to mow in both directions and control direction of cut material
- Available with multiple motors and mounts to fit 3-10 ton excavators

Specifications									
Model	Excavator Size (metric ton)	Cutting Width	Housing Width	Operating Weight w/ mount	Hydraulic Flow	Pressure	Rotational Speed	Number of Blade Stands	Cutting Capacity
FME30 Standard	3.0-6.0	28.5"	32"	880 lbs	8-28 gpm	4000 psi	1800-2200 rpm	8	4"
FME30 Thumb Ready	3.0-6.0	28.5"	32"	905 lbs	8-28 gpm	4000 psi	1800-2200 rpm	8	4"
FME40 Thumb Ready	6.0-10.0	38.5"	42"	1,225 lbs	17-40 gpm	5000 psi	1800-2200 rpm	10	4"



- **Operating weight in metric tons will determine if the FME30 or FME40 is appropriate. FME30 = 3t-6t, FME40 = 6t-10t**
- **Lift over side capacity at maximum reach at ground level - this is where the attachment will most likely be while it is working. This weight capacity needs to be suitable for the size and type of flail being considered. Sometimes a 3.5t excavator, even though it is in the operating weight range, does not have enough lift over side capacity to be able to lift the flail mower safely at max reach. The lift over side at max reach information is difficult to find as many OEM's don't publish this information so sometimes we may need the dealer to assist us in gathering this info. This is often the case with the smaller 3t-4t excavators.**
- **Auxiliary flow (flow available to the attachment) – this will determine the appropriate motor group to use.**
- **Case drain is required.**

FLAIL MOWERS FOR EXCAVATORS



INCLUDES: FLAIL MOWER ASSEMBLY. SHIPS WITHOUT HOSES AND COUPLERS DUE TO VARIATIONS BETWEEN MACHINES WITH REGARDS TO HYDRAULIC COUPLER PLACEMENT. TO ORDER: CHOOSE FLAIL MOWER ASSEMBLY AND MOUNT.

COMMONLY CONFIGURED ITEMS		
30" Excavator Flail Mower Standard w/ GPM Range 14-16	23130D-E0228	
30" Excavator Flail Mower Standard w/ GPM Range 17-22	23130E-E0852	
30" Excavator Flail Mower Standard w/ GPM Range 22-28	23130F-E0152	
30" Excavator Flail Mower TR w/ GPM Range 14-16 (thumb saddle ordered separately)	23131D-E1091	
30" Excavator Flail Mower TR w/ GPM Range 17-22 (thumb saddle ordered separately)	23131E-E5057	
30" Excavator Flail Mower TR w/ GPM Range 22-28 (thumb saddle ordered separately)	23131F-E0152	
40" Excavator Flail Mower TR w/ GPM Range 17-22 (thumb saddle ordered separately)	23140E-E0081	
40" Excavator Flail Mower TR w/ GPM Range 22-28 (thumb saddle ordered separately)	23140F-E0333	
40" Excavator Flail Mower TR w/ GPM Range 27-33 (thumb saddle ordered separately)	23140G-E0333	
EXCAVATOR FLAIL MOWER ASSEMBLY (HOSES AND COUPLERS NOT INCLUDED)	ORDER CODE* WITH SUFFIX CODE BELOW FOR MOUNT	SHIP WEIGHT (LBS)
Standard - No Thumb Capacity		
30" Excavator Flail Mower Standard w/ GPM Range 8-9	23130A	880
30" Excavator Flail Mower Standard w/ GPM Range 10-11	23130B	880
30" Excavator Flail Mower Standard w/ GPM Range 12-14	23130C	880
30" Excavator Flail Mower Standard w/ GPM Range 14-16	23130D	880
30" Excavator Flail Mower Standard w/ GPM Range 17-22	23130E	880
30" Excavator Flail Mower Standard w/ GPM Range 22-28	23130F	880

FLAIL MOWERS

FLAIL MOWERS FOR EXCAVATORS CONT.

EXCAVATOR FLAIL MOWER ASSEMBLY (HOSES AND COUPLERS NOT INCLUDED)	ORDER CODE* WITH SUFFIX CODE BELOW FOR MOUNT	SHIP WEIGHT (LBS)
---	--	----------------------

Thumb Ready		
30" Excavator Flail Mower TR w/ GPM Range 8-9 (thumb saddle ordered separately)	23131A	905
30" Excavator Flail Mower TR w/ GPM Range 10-11 (thumb saddle ordered separately)	23131B	905
30" Excavator Flail Mower TR w/ GPM Range 12-14 (thumb saddle ordered separately)	23131C	905
30" Excavator Flail Mower TR w/ GPM Range 14-16 (thumb saddle ordered separately)	23131D	905
30" Excavator Flail Mower TR w/ GPM Range 17-22 (thumb saddle ordered separately)	23131E	905
30" Excavator Flail Mower TR w/ GPM Range 22-28 (thumb saddle ordered separately)	23131F	905

EXCAVATOR FLAIL MOWER ASSEMBLY (HOSES AND COUPLERS NOT INCLUDED)	ORDER CODE* WITH SUFFIX CODE BELOW FOR MOUNT	SHIP WEIGHT (LBS)
---	--	----------------------

Thumb Ready cont.		
40" Excavator Flail Mower TR w/ GPM Range 17-22 (thumb saddle ordered separately)	23140E	1225
40" Excavator Flail Mower TR w/ GPM Range 22-28 (thumb saddle ordered separately)	23140F	1225
40" Excavator Flail Mower TR w/ GPM Range 27-33 (thumb saddle ordered separately)	23140G	1225
40" Excavator Flail Mower TR w/ GPM Range 32-40 (thumb saddle ordered separately)	23140H	1225

OPTIONS	ORDER CODE	SHIP WEIGHT (LBS)
Saddles for 30" and 40" Thumb Ready Flail Mowers		
Thumb Saddle (Factory Install)	28-10747	90
Thumb Saddle (Field Install)	28-10833	90

EXCAVATOR MOUNTS (ONE REQUIRED - CONTACT FACTORY FOR MOUNTS NOT LISTED)				
--	--	--	--	--

MAKE	MODELS	PIN-ON / COUPLER	SUFFIX CODE	SHIP WEIGHT (LBS)
Bobcat	331/334/430 ZHS	Pin-on	-E0331	120
Bobcat	E80/E85 M	Pin-on	-E1075	120
Bobcat	442	Pin-on	-E0442	120
C&P	027 QH	Coupler	-E0852	120
C&P	030 QH	Coupler	-E0333	120
Case	CX55B MTS/CX50B	Pin-on	-E2051	120
Case	CX55		-E2051C	120
Case	CX37C/CX33C	Pin-on	-E0535	120
Case	CX60/CX60C/CX57C	Pin-on	-E1060	120
Case	CX36/CX36B/CX31	Pin-on	-E3354	120
Case	CX80C	Pin-on	-E1600	120
Case	9007B/CX 75SR/9007/CX 75C/CX80	Pin-on		120
Case	580M/580SL/580K/580L/590/680/580SM	Pin-on	-R0580	120
Case	580SN/580N/580EV/580N EP	Pin-on	-R3580	120
CAT	304/304C/304C CR/305.5/305.5D/305.5D CR/305.5E/3.5.5E CR/305.5E2/305C CR/305E/305E CR/305E2 CR/306 CR	Pin-on	-E0304	120
CAT	420F/415F/415F2/416D/416E/416F/416F2/420D/420E/420F/420F2/424D/428D/428E/428F/430D/430E/430F/430F2/432D/432E/432F/438D/442D	Pin-on	-R0430	120
CAT	304 E2 CR/303 CR/303.5/303.5C/303.5C CR/303.5D/303.5D CR/303.5E/303.5E2 CR/303C/304D/304E/304E CR/304E2	Pin-on	-E3303	120
CAT	307/307B/308B/307C/308/E70B	Pin-on	-E0070	120
CAT	308 E2 CR SB/307E2/308E CR SB/307D/307E/308E/308E2 CR/308D	Pin-on	-E1308	120
Daewoo	SOLAR 75-V	Pin-on	-E1075	120
Doosan	DX85R/DX89R-7/DX85R-3/DX80R/DX85-3	Pin-on	-E1075	120
Gehl	ME3003/353/303/373/383Z	Pin-on	-E0223	120
Gehl	503Z	Pin-on	-E0503	120
Gehl	Z45/Z55	Pin-on	-E0050	120
Gehl	100M/Z80	Pin-on	-E1171	120
Geith	S9	Coupler	-E1601	120

FLAIL MOWER EXCAVATOR MOUNTS CONTINUED NEXT PAGE

FLAIL MOWERS FOR EXCAVATORS CONT.

EXCAVATOR MOUNTS (ONE REQUIRED - CONTACT FACTORY FOR MOUNTS NOT LISTED)				
MAKE	MODELS	PIN-ON / COUPLER	SUFFIX CODE	SHIP WEIGHT (LBS)
Hitachi	ZX75US-5/EX 80U/EX 60-5/ZX85USB-5/ZX80US-3/EX80/ZX75US-3/ ZX80/EX 75US		-E0081	120
Hitachi	ZX50U-5/ZX50U-2/EX50U/ZX50U-3/EX45-2/EX40-2	Pin-on	-E5050	120
Hitachi	ZX50U-5/ZX60USB-3/ZX50U/ZX50U-2/ZX50U-3/ZX60USB-5	Coupler	-E0153	120
Hyundai	R35Z-9/R35Z-9A	Pin-on	-E0535	120
Hyundai	R60CR-9A/R55-9A/R60-9S/R55-9/HW60/RC60CR-9/HX60/R60W-9S	Pin-on	-E1060	120
Hyundai	R80CR-9/HX85	Pin-on	-E0809	120
Ingersoll Rand	ZX-75	Pin-on	-E0442	120
JCB	JZ 70/JS 70/JS 85LC/JS 85	Pin-on		120
JCB	8045 ZTS/8040 ZTS/8055/8050	Pin-on	-E8045	120
JCB	8052/100C/214/214E/214S/215/215E/215S/217/8060/8065/800/85Z/86C/ 90Z	Pin-on	-E0214	120
JCB	3CX/3CX-14/3CX-4/3CX-15 SUPER /3CX-14 SUPER/4CX-4	Pin-on	-R0214	120
John Deere	35 ZTS/ZX35U-5/ZX35U-3/ZX35U-2/ZX27U-3/ZX27U-2/ZX26U-5/35G ZTS/35D ZTS/35C ZTS/35 ZTS/27D ZTS/27C ZTS/26G ZTS/110	Coupler	-E0228	120
John Deere	310SJ/310SG/310SK/310SL/3155SG/315SJ/315SK/315SL/320P/410G/410J/4 10K/410L/410P	Pin-on	-R0010	120
John Deere	85/85G/80C/80/75D/85D		-E0081	120
John Deere	50G/50C/50 ZTS/50D	Pin-on	-E5050	120
John Deere	50D ZTS/60G ZTS/50 ZTS/50G ZTS/60P	Coupler	-E0153	120
John Deere	50	Pin-on	-E0050	120
Kobelco	SK50 SR-3/SK55 SRX-6E/SK45 SR-6E/SK50 SR-5/SK55 SRX	Pin-on	-E2051	120
Kobelco	SK 35SR-5/SK 30SR-3/SK 30SR-5/SK 35SR-3	Pin-on	-E3354	120
Kobelco	SK85/SK85CSS-3E/K 903 MKII/80 CS/K03/SK 60 MK III/SK80CS-3/ SK85CS	Pin-on	-E2070	120
Komatsu	PC78/PC95/PC88US-8/PC88US-10/PC88MR-8/PC88MR-6/PC88MR-3/ PC88MR-11/PC88MR-10/PC88/PC80/PC78US-8/PC78US-6/PC78US-11/ PC78U-10/PC78MR-6/PC78 US-6/PC78/PC75UU/PC70-8/PC660-7B/PC60- 7/PC60-6/PC60-5/PC60-4/PC60-3/PC60-2/PC60	Pin-on	-E0060	120
Kubota	K7770/K7870 coupler/KX040-4/KX018-4/KX-121-3/KX41-3/KX71-3/KX91-3/ L39/L45/L48/M59/U15/U17/U25S/U35/U35S	Coupler	-E1091	120
Kubota	KX121/KH91/KH121/KH90/KH91/KX033-4/KX040-4/KX101/KX121-2/KX121-3/ KX1213S/KX121SR-2/KX71-3/KX71-3S/KX91/KX91-2/KX91-3/U35/U35 R1/ U35-4	Pin-on	-E0091	120
Kubota	K7915 coupler/U55-4/KX057-4	Coupler	-E5057	120
Kubota	KX161/U55-4/U45/KX161-3S/KX161-3/KX161-2SR2/KX161-2/KX151/KH161/ KH151/KH040/K161	Pin-on	-E0151	120
Kubota	K7880 coupler/KX040-4/KX161-3	Coupler	-E1151	120
Kubota	KX057-4/KX057-5	Pin-on	-E5055	120
Kubota	KX057 CANADA	Coupler	-E5056	120
Kubota	KX080-3	Pin-on	-E3080	120
Kubota	K7402 coupler/KX080-4/KX080-3	Coupler	-E4080	120
Kubota	K7402 HEAVY MOUNT/KX080-4/KX080-3	Coupler	-E4080HM	120
Mitsubishi	MS70	Pin-on		120
Mustang	3503/3503B/3003/3703	Pin-on	-E0223	120
Mustang	5003/5003ZT	Pin-on	-E0503	120
Mustang	550Z/450Z	Pin-on	-E0050	120
Mustang	800Z	Pin-on	-E1171	120
New Holland	EH50.B/E55BX/E50B	Pin-on	-E2051	120
New Holland	E37C/E33C	Pin-on	-E0535	120
New Holland	E60C/E57C	Pin-on	-E1060	120
New Holland	EH35.B/EH30/E30B/E35B	Pin-on	-E3354	120

FLAIL MOWER EXCAVATOR MOUNTS CONTINUED NEXT PAGE

FLAIL MOWERS

FLAIL MOWERS FOR EXCAVATORS CONT.

FLAIL MOWERS

EXCAVATOR MOUNTS (ONE REQUIRED - CONTACT FACTORY FOR MOUNTS NOT LISTED)				
MAKE	MODELS	PIN-ON / COUPLER	SUFFIX CODE	SHIP WEIGHT (LBS)
New Holland	EH800	Pin-on	-E2070	120
Sany	SY60C	Pin-on	-E6060	120
Schaeff	ZX-75	Pin-on	-E0442	120
Steelwrist	S50 COUPLER	Coupler	-E9950	120
Takeuchi	53/TB045/TB145/53FR/TB153FR/TB250/TB53FR	Pin-on	-E0045	120
Takeuchi	TB240/TB035/TB135/TB138FR/TB235	Pin-on	-E0135	120
Takeuchi	TB260	Pin-on	-E2260	120
Takeuchi	TB175/TB070/TB180/TB180FR/TB285/TB290	Pin-on	-E0071	120
Terex	HR32	Pin-on	-E0442	120
Volvo	EC88/ECR88	Pin-on	-E0088	120
Volvo	EC55	Pin-on	-E2055	120
Wacker Neuson	28Z3/EZ26/3703/38Z3/3003/EZ28/3503/EZ38/EZ36	Pin-on	-E0223	120
Wacker Neuson	EZ53/6503/50Z3/6003	Pin-on	-E0503	120
Wacker Neuson	EW65/ET65	Pin-on	-E0565	120
Wacker Neuson	ET90	Pin-on	-E3090	120
Werk-Brau	KLAC-E		-E3355	120
Yanmar	ViO45/VO40/ViO55-5/B 6/ViO45-5/ViO50-2/VO50/B 5/ViO40-2/B50-2B	Pin-on	-E0050	120
Yanmar	ViO-80/B7 SIGMA/B7-3/SV100/ViO-70/ViO-75/VO75/Z80	Pin-on	-E1171	120
	NO MOUNT	NO MOUNT	-EBLNK	

	ORDER CODE	SHIP WEIGHT (LBS)
Blade set for 30" flail mower (includes 16 curved and 8 straight blades)	28-10821	50
Blade set for 40" flail mower (includes 20 curved and 10 straight blades)	28-10822	60
Flail Blade Curved - Individual	07-8235	
Flail Blade Strait - Individual	07-8236	
Bolt and nut kit for flail mower (includes 2 bolts and 2 slotted nuts)	28-10823	5
Roll pin kit for flail mower (includes 2 roll pins)	28-10824	1
Deflector kit for 30" flail mower (includes 1 deflector and hardware)	28-10827	10
Deflector kit for 40" flail mower (includes 1 deflector and hardware)	28-10828	10
Skid shoe kit (includes 1 skid shoe and hardware)	28-10826	15
Bearing kit (includes 1 bearing and hardware)	28-10825	15
Torsion disc kit (includes 1 torsion disc and hardware)	28-10829	15

FORKS & CARRIAGES



FORKS & CARRIAGES

CAR FORK CARRIAGES

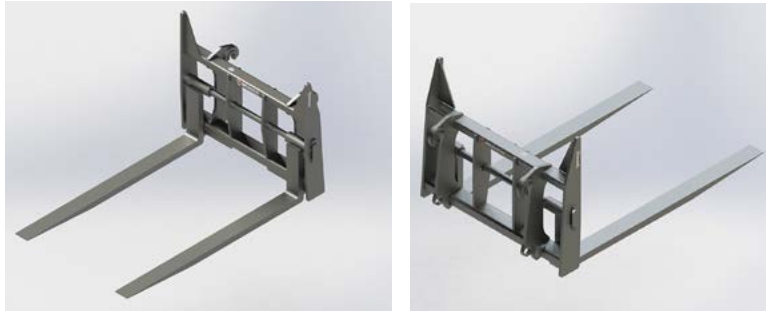

- 5,000 to 21,000 pound capacities
- Full floating pin design
- "Bat ear" load back rest allows for open center for improved visibility



CAR FORK CARRIAGES FOR TRACTOR LOADERS/BACKHOES AND WHEEL LOADERS



NOTE: CAR FORK & FRAMES FEATURE A SINGLE FORK SHAFT GOING FULL WIDTH OF THE CARRIAGE WITH SHAFT SUPPORT PLATE IN THE CENTER FOR ADDED STRENGTH. THIS SUPPORT ALSO TIES IN THE LOWER AND UPPER CROSS TUBES IN THE CENTER. ADDITIONALLY, WE FEATURE A RETAINER DEVICE ON THE LOWER SIDE OF THE CARRIAGE TO HOLD THE FORK TIPS RIGID THEREBY ALLOWING FOR EASY CRUSHING OF THE CAR TOP. "BAT EAR" STYLE LOAD BACK REST ALLOWS FOR OPEN CENTER LOAD BACK REST FOR OPTIMAL VISIBILITY. TOP CHISEL TAPER IS STANDARD ON ALL CAR FORKS.

CAR FORK CARRIAGES (FRAME & FORKS)	ORDER CODE	SHIP WEIGHT (LBS)	LIST PRICE
60" wide with 2.5" x 6" x 84" top chisel forks (21,000 lb cap)			
21,000 lb. cap, 2.25" shaft - uses 2.5" x 6" wide forks			
JCB 411/416/426/436 w/HT coupler "Bat Ear style back rest"	12614	1660	\$7,192
JCB 416 5 x 6 84" forks	12672	1660	\$5,121
John Deere 444C pin mount	12507	675	\$2,648
New Holland LW130-170 w/ quick coupler	12614	1660	\$7,192
Volvo L70-L120 w/quick coupler	12614	1660	\$7,192
60" wide with 2.5" x 6" x 84" bottom chisel forks (21,000 lb cap)			
JCB 411 / 416 / 426 / 436 with quick coupler	12824	1600	\$7,453
New Holland LW130-170W with quick coupler	12824	1600	\$7,453
Volvo L30-120 with quick coupler	12824	1600	\$7,453

PALLET FORK FRAME



- Heavy-duty frame designed to handle 4,000 lb. to 6,200 lb. fork capacities
- Brick guard offers strength & smooth surfaces for protection against load damage
- Patented design offers excellent visibility & includes load securing "D" ring
- 42", 48", 60" and 72" tines available
- Personalized logo burned into brick guard available on standard model
- Standard, Extended, Walk-Thru available
- NEW Walk-Thru carriage design has an open frame for easy, safe access to operator compartment on loader

Specifications	Overall Height	Overall Width	Max Tine Spacing	Min Tine Spacing	ITA Category II Fork Mounting
standard width	39"	55"	43"	12"	16"
extended width	39"	65"	59"	13"	16"
walk-thru	38"	50.5"	43"	12"	16"

PALLET FORK FRAMES - CLASS II ITA FOR SKID-STEER LOADERS



Tines Sold Separately A (5500 LB Capacity)

STANDARD AND WALK-THRU PALLET FORK FRAME - CLASS II ITA	ORDER CODE	SHIP WEIGHT (LBS)
45" Signature Series Standard pallet fork frame (left or right hand bolt on step)	30945-0022	270
45" Bradco Signature Series (2") Drop Height Pallet Frame (left or right hand bolt on step)	30946-0022	270
45" Standard walk-thru single step pallet fork frame (left or right hand bolt on step)	30947-0022	260
45" Standard walk-thru (2" drop) pallet fork frame (left or right hand bolt on step)	30948-0022	260
45" Standard walk-thru single step pallet fork frame (left or right hand bolt on step), custom logo	30951-0022	260
60" universal (2") Drop Tine Height	119401	265

PALLET FORK TINES	ORDER CODE	SHIP WEIGHT (LBS)
Standard Pallet Fork Tines (pair)		
42" tines (4,000 lb.)	66302	168
48" tines (4,000 lb.)	67604	186
Heavy-Duty Pallet Fork Tines (pair)		
42" tines (6,000 lb.)	85962	225
48" tines (6,000 lb.)	85994	250
60" tines (6,200 lb.)	12678	300
72" tines (6,200 lb.)	12509	380

PALLET FORK FRAMES CONTINUED NEXT PAGE

FORKS & CARRIAGES

PALLET FORK FRAME CONT.

PALLET FORK FRAME - CLASS II ITA FOR SKID-STEER LOADERS CONT.

PALLET FORK TINES CONT.		ORDER CODE	SHIP WEIGHT (LBS)
Value Fork Tines (pair)			
42" tines (3,750 lb.)		102028	218
48" tines (3,750 lb.)		102030	250
42" tines (5,500 lb.)		102032	260
48" tines (5,500 lb.)		102034	270
Block Tines			
1.5 x 2 x 48" set of 6 ITA class II		11995	349
2" x 2" x 48" set of 4		32984	353

OPTIONS		ORDER CODE	SHIP WEIGHT (LBS)
Bale Spike Assembly (must order pallet fork frame)			
2-spear, ITA mount		17253	56
3-spear, ITA mount		17240	81
Tow Hitch Assembly			
optional tow hitch		100899	37
Assembly Charge (assemble tines to pallet fork frame at factory)			
net cost per each unit assembled			contact factory

PALLET FORK FRAME - CLASS II ITA FOR COMPACT TRACTORS



PALLET FORK (ITA PALLET FORK WITH UNIVERSAL SKID-STEER COUPLER HITCH)		ORDER CODE	SHIP WEIGHT (LBS)
pallet fork assembly with 42" tines		108308	252
pallet fork assembly with 48" tines		108309	283

OPTIONS		ORDER CODE	SHIP WEIGHT (LBS)
Auger mount assembly ITA Class II		17253	56
3-spear, ITA mount bale spike assembly - must order pallet fork frame		17240	81
Tow Hitch Assembly			
optional tow hitch		100899	37

PALLET FORK FRAME - CLASS II ITA FOR EURO/GLOBAL MOUNTS



STANDARD PALLET FORK FRAME - CLASS II ITA		ORDER CODE	SHIP WEIGHT (LBS)
Euro / Global mount 48" wide		109065	237
Euro / Global mount 60" wide		115890	195

PALLET FORK TINES		ORDER CODE	SHIP WEIGHT (LBS)
Standard Pallet Fork Tines (pair)			
42" tines (4,000 lb.)		66302	168
48" tines (4,000 lb.)		67604	186

PALLET FORK TINES CONTINUED NEXT PAGE

PALLET FORK FRAME CONT.

PALLET FORK FRAME - CLASS II ITA FOR EURO/GLOBAL MOUNTS CONT.

PALLET FORK TINES CONT.	ORDER CODE	SHIP WEIGHT (LBS)
Heavy-Duty Pallet Fork Tines (pair)		
42" tines (6,000 lb.)	85962	225
48" tines (6,000 lb.)	85994	250
60" tines (6,200 lb.)	12678	300
72" tines (6,200 lb.)	12509	380
Value Fork Tines (pair)		
42" tines (3,750 lb.)	102028	218
48" tines (3,750 lb.)	102030	250
42" tines (5,500 lb.)	102032	260
48" tines (5,500 lb.)	102034	270
Block Tines		
1.5 x 2 x 48" set of 6 ITA class II	11995	349
2" x 2" x 48" set of 4	32984	353

OPTIONS	ORDER CODE	SHIP WEIGHT (LBS)
Bale Spike Assembly (must order pallet fork frame)		
2-spear, ITA mount	17253	56
3-spear, ITA mount	17240	81
Tow Hitch Assembly		
optional tow hitch	100899	37
Assembly Charge (assemble tines to pallet fork frame at factory)		
net cost per each unit assembled	contact factory	

PALLET FORK FRAME - CLASS II ITA FOR TRACTOR LOADERS



STANDARD PALLET FORK FRAME - CLASS II ITA	ORDER CODE	SHIP WEIGHT (LBS)
John Deere 400/500 tractor loader	15540	188
John Deere 600/700 tractor loader	18010	249
PALLET FORK TINES	ORDER CODE	SHIP WEIGHT (LBS)
Standard Pallet Fork Tines (pair)		
42" tines (4,000 lb.)	66302	168
48" tines (4,000 lb.)	67604	186
Heavy-Duty Pallet Fork Tines (pair)		
42" tines (6,000 lb.)	85962	225
48" tines (6,000 lb.)	85994	250
60" tines (6,200 lb.)	12678	300
72" tines (6,200 lb.)	12509	380
PALLET FORK TINES CONTINUED NEXT PAGE		

FORKS & CARRIAGES

PALLET FORK FRAME CONT.

PALLET FORK FRAME - CLASS II ITA FOR TRACTOR LOADERS CONT.

PALLET FORK TINES CONT.		ORDER CODE	SHIP WEIGHT (LBS)
Value Fork Tines (pair)			
42" tines (3,750 lb.)		102028	218
48" tines (3,750 lb.)		102030	250
42" tines (5,500 lb.)		102032	260
48" tines (5,500 lb.)		102034	270
Block Tines			
1.5 x 2 x 48" set of 6 ITA class II		11995	349
2" x 2" x 48" set of 4		32984	353

OPTIONS		ORDER CODE	SHIP WEIGHT (LBS)
Bale Spike Assembly (must order pallet fork frame)			
2-spear, ITA mount		17253	56
3-spear, ITA mount		17240	81
Tow Hitch Assembly			
optional tow hitch		100899	37
Assembly Charge (assemble tines to pallet fork frame at factory)			
net cost per each unit assembled		contact factory	

PALLET RAIL STYLE FORK

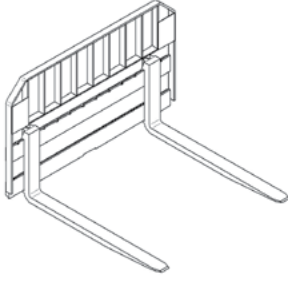

- Heavy duty, Class III pallet fork frame for wheel loaders, backhoes and telehandlers with lift capacities of up to 10,000 lbs
- Back frames available in 48", 60", and 72" widths
- Tines available in 42", 48", and 60" lengths for a variety of applications

Carrier Specifications	
Lift Capacity	Operating Weight
<10,000 lbs	<32,000 lbs
<10,000 lbs	<32,000 lbs
<10,000 lbs	<32,000 lbs

Specifications - Class III Fork Carriages						
Model #	Weight (approx)	Max. Lift Cap.	Width OD	Fits	Tine Length	
10022	460 lbs	10,000 lbs	48"	Wheel & Backhoe Loaders	NA	
10047	600 lbs	10,000 lbs	60"	Wheel & Backhoe Loaders	NA	
10021	750 lbs	10,000 lbs	72"	Wheel & Backhoe Loaders	NA	

Specifications - Kits for Class III Forks*			
Model #	Weight (Approx.)	Depth OD	Fork Size
10043	256 lbs	45.625"	2x5x42"
10044	320 lbs	51.625"	2x5x48"
10045	399 lbs	63.625"	2x5x60"

Check capacity and limits of loader before ordering.

**Includes set of 2 forks, only required if purchasing Class III Forks*

INCLUDES: PALLET RAIL STYLE FORK. TO ORDER :CHOOSE FORK, MOUNTING AND KIT FOR CLASS III FORKS.
NOTE: SHIPPING WEIGHTS VARY DEPENDING ON LOADER MOUNTING AND PACKAGING.

CLASS III RAILSTYLE PALLET FOR WHEEL LOADERS AND BACKHOE LOADERS



PALLET FORKS CHECK LOADER CAPACITY BEFORE ORDERING			ORDER CODE	SHIP WEIGHT (LBS)
Does NOT Include Tines				
48" OD Class III Railstyle Pallet Forks w/out forks			10022	460
60" OD Class III Railstyle Pallet Forks w/out forks			10047	600
72" OD Class III Railstyle Pallet Forks w/out forks			10021	1010

MOUNTING - ADDITIONAL COST MAY APPLY			ORDER CODE	SHIP WEIGHT (LBS)
Contact Customer Service at (833) 723-1843				

KIT FOR CLASS III FORKS - INCLUDES SET OF 2 FORKS (ONLY REQUIRED IF PURCHASING CLASS III FORKS)			ORDER CODE	SHIP WEIGHT (LBS)
2x5x42" Class III Fork Kit			FFC10043	256
2x5x48" Class III Fork Kit			FFC10044	320
2x5x60" Class III Fork Kit			FFC10045	399

FORKS & CARRIAGES

FLOATING PIN CARRIAGES



- 48" to 84" widths available
- Full floating pin design

FLOATING PIN CARRIAGES FOR TRACTOR LOADERS/BACKHOES



	ORDER CODE	SHIP WEIGHT (LBS)
48"		
blank-no mounts 10,000 lb cap, 2.25" shaft	12357	520
Cat IT/TH 10,000 lb cap 60mm shaft	11715	500
66"		
Cat IT/TH 10,000 lb cap 60mm shaft	11435	825
JCB Q-fit 10,000 lb cap 2.25" shaft	11428	490
74"		
Cat IT/TH 10,000 lb cap 60mm shaft	11714	583
JCB Q-fit 10,000 cap 2.25" shaft	11504	975

FLOATING PIN CARRIAGES FOR WHEEL LOADERS



	ORDER CODE	SHIP WEIGHT (LBS)
48"		
blank-no mounts 10,000 lb cap, 2.25" shaft	12357	520
Cat 902/906/908 10,000 lb cap 60mm shaft	12569	520
Cat IT/TH 10,000 lb cap 60mm shaft	11715	500
60"		
Cat IT/TH 10,000 lb cap 60mm shaft	11435	825
JCB 411,416,426,436 w/ HT coupler uses 2.5" x 6" wide forks	12341	600
JCB 411/416/426/436 with HT coupler (21,000 lb cap 2.25" shaft uses 2.5x6" wide forks)	12371	670
JCB 411-416 5 x 6 x 72" forks (forks included)	12824	1600
JCB 416 5 x 6 x 48" forks (forks included)	12614	1660
JCB 416 5 x 6 84" forks (forks included)	12672	1660
John Deere 444C pin mount	12507	675
JRB 416 hitch 21,400# rated	12897	735
New Holland LW130-170 w/ quick coupler uses 2.5" x 6" wide	12341	600
Volvo L70-L120 w/quick coupler uses 2.5" x 6" wide forks	12341	600
74"		
Cat IT/TH 10,000 lb cap 60mm shaft	11714	583
84"		
JCB 411,416,426,436 w/ HT coupler "Bat Ear style back rest"	12377	890
New Holland LW130-170 w/ quick coupler	12377	890
Volvo L70-L120 w/quick coupler	12377	890

PALLET FORK FRAME - SHAFT



- Standard brick guard
- Adjustable tines
- Utilizes shaft styles 1.38 x 4.75 x 42" or 48"
- 42" and 48" fork tines lengths available

PALLET FORK FRAME - SHAFT FOR COMPACT TRACTORS



	ORDER CODE	SHIP WEIGHT (LBS)
42" forks, shaft style pallet fork	10703-42-0822	335
48" forks, shaft style pallet fork	10703-48-0822	355

FORK POSITIONERS - SIDE SHIFT



- 4" left and right shift for 8" overall movement
- 48", 60", 66", & 74" widths available
- 5,000 lb to 12,000 lb capacities
- Floating pin & ITA configurations

SIDE SHIFT CARRIAGES FOR SKID STEER LOADERS



	ORDER CODE	SHIP WEIGHT (LBS)
48"		
SSL Universal Hitch 2-1/4" shaft	13441	806

SIDE SHIFT CARRIAGES FOR TRACTOR LOADERS/BACKHOES



	ORDER CODE	SHIP WEIGHT (LBS)
48"		
Cat IT/TH 10,000 lb cap 60mm	11324	745
JCB 10,000 lb cap ITA class III	12659	1005
JCB & New Holland 10,000 lb cap 2 1/4" shaft	12633	745
74"		
Cat IT/TH 10,000 lb cap 60mm shaft	11510	800

SIDE SHIFT CARRIAGES FOR WHEEL LOADERS



	ORDER CODE	SHIP WEIGHT (LBS)
48"		
Cat IT/TH 10,000 lb cap 60mm shaft	11324	745
74"		
Cat IT/TH 10,000 lb cap 60mm shaft	11510	800

FORKS & CARRIAGES

FORK POSITIONERS - SIDE TILT WITH FLOATING PIN



- 10° left and right tilt, min. 20° overall minimal tilt
- 48", 60", 66", & 72" widths available
- 5,000 lb to 12,000 lb capacities
- Counter balance cylinders hold carriage in position upon a loss of pressure

SIDE TILT CARRIAGES FOR TRACTOR LOADERS/BACKHOES



	ORDER CODE	SHIP WEIGHT (LBS)
48"		
Cat IT/TH 10,000 lb cap 60mm shaft	11294	900
72"		
Cat IT/TH 10,000 lb cap 60mm shaft	11709	780

SIDE TILT CARRIAGES FOR WHEEL LOADERS



	ORDER CODE	SHIP WEIGHT (LBS)
48"		
Cat IT/TH 10,000 lb cap 60mm shaft	11294	900
72"		
Cat IT/TH 10,000 lb cap 60mm shaft	11709	780

FORK POSITIONERS WITH FORKS

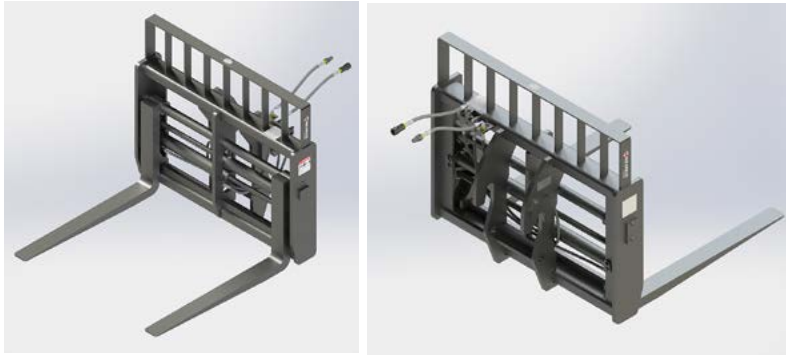

- 48", 60", 72", & 78" widths available
- 5,000 to 10,000 lb capacity
- Forks are hydraulically operated to move apart or together for accurate & fast positioning in pallets
- Optional side shift version available

FORK POSITIONERS WITH FORKS FOR TRACTOR LOADERS/BACKHOES



	ORDER CODE	SHIP WEIGHT (LBS)
48" Fork Positioner with Forks		
Cat IT 2 x 5 x 60" forks 10,000 lb cap 2.25" shaft Cat 416C IT, 420D IT	12444	1166
Cat IT only 2 x 5 x 48" forks 10,000 lb cap 2.25" shaft Cat 416C IT, 420D IT	11311	1025
Cat IT 2x5x72" forks 10,000 lb cap 2.25" shaft Cat 416C IT, 420D IT, 430D IT only	12634	1266
JCB 210S/212S 2 x 5 x 48" forks 10,000 lb cap 2.25" shaft	12474	1153
JCB Q-fit 2 x 5 x 48" forks 10,000 lb cap 2.25" shaft JCB Q-Fit 214 / 215 / 217	12407	1020
JRB HV100 2 x 5 x 48" forks	12669	1136
JRB HV100 2 x 5 x 48" forks	12669	1136
48" Side-Shift Fork Positioner with Forks		
Cat IT/TH 2 x 5 x 48" forks 10,000 lb cap 2.25" shaft Cat 416C IT, 420D IT, 430D IT	11329	1025
72" Fork Positioner with Forks		
Cat IT/TH 2 x 5 x 48" forks 10,000 lb cap 2.25" shaft Cat 416C IT, 420D IT, 430D IT	11474	1285
Cat IT 2 x 5 x 48" forks 10,000 lb cap 2.25" shaft Cat 416C IT, 420D IT, 430D IT	12588	1285
FFC QCP 7000 w/2 x 5 x 60" forks 10,000 lb cap 2.25" pin	13208	1505
JCB Q-fit 2 x 5 x 72" forks	12623	1431
FORK POSITIONERS WITH FORKS CONTINUED NEXT PAGE		

FORKS & CARRIAGES

FORK POSITIONERS WITH FORKS CONT.



FORK POSITIONERS WITH FORKS FOR WHEEL LOADERS

	ORDER CODE	SHIP WEIGHT (LBS)
48" Fork Positioner with Forks		
Cat IT14, IT24 only 2 x 5 x 60" forks 10,000 lb cap 2.25" shaft	12444	1166
Cat IT 14 only 2 x 5 x 72" forks 10,000 lb cap 2.25" shaft	12634	1266
Cat IT only 2 x 5 x 48" forks 10,000 lb cap 2.25" shaft	11311	1025
JRB HV100 2 x 5 x 48" forks	12669	1136
New Holland LW50B 2 x 4 x 48" forks 8,000 lb cap 2¼" shaft	12446	963
72" Fork Positioner with Forks		
Cat IT14, IT24 only 2 x 5 x 48" forks 10,000 lb cap 2.25" shaft	12588	1285
JCB 400 Series 2 x 5 x 72" forks	12870	1425
JCB 411, 416, 426, 436 2 x 5 x 48" forks 10,000 lb cap	12769	1340
JCB 416HT 2.50 x 6.00 x 48" forks	12983	1620
New Holland LW130-170 2x5x48" forks 10,000 lb cap	12769	1340
Volvo L70-L120 2x5x48" forks 10,000 lb cap	12769	1340
72" Side-Shift Fork Positioner with Forks (10,000 lb. cap)		
Cat IT/TH 2 x 5 x 48 forks	12930	1470
Cat IT14, IT24 hitch only 2 x 5 x 60" forks	11489	1470
72" Side-Tilt Fork Positioner with Forks (10,000 lb. cap)		
Cat IT14, IT24 hitch only 2 x 5 x 72" forks	12448	1960

FORKS - BLOCK TINES



- Typically used for handling pallets of brick and block



8,000 lb. capacity requires four (4) 2" x 2" tines
10,000 lb. capacity requires six (6) 2" x 2" tines

FORKS - BLOCK TINES FOR TRACTOR LOADERS/BACKHOES AND WHEEL LOADERS



	ORDER CODE	SHIP WEIGHT (LBS)
1.5 x 2 x 48" set of 6 ITA class II	11995	349
1.5 x 2 x 48" set of 6 JCB 1.75" pin	12431	500
2 x 1.5 x 48" set of 6 JCB 2" pin dia	12482	450

FORKS & CARRIAGES

FORKS - FLOATING PIN



- 2,300 to 21,000 lb capacities
- Shaft mount & ITA configuration fork styles available
- Cubing or block tines, brick forks, standard chisel low back & high back styles and negative drop forks

FORKS - FLOATING PIN FOR TRACTOR LOADER/BACKHOES



6,860 LB. LOAD-RATED FORKS (PAIR)	ORDER CODE	SHIP WEIGHT (LBS)
1.75 x 4 x .48" pair Cat 60mm	12765	280
1.75 x 4 x 48" pair JCB 2" pin	12367	280
1.75 x 4 x 60" pair JCB 520/523, 1.75" shaft	12309	280
1.75 x 4 x 84" pair JCB 520, 1.75" shaft	12411	280
1.75 x 4 x 84" pair SkyTrak 2" shaft	12483	280

10,000 LB. LOAD-RATED FORKS (PAIR)	ORDER CODE	SHIP WEIGHT (LBS)
2 x 5 x 48" pair Cat 60mm pin dia	12253	380
2 x 5 x 48" pair JCB 2.25" pin dia	12014	380
2 x 5 x 48" pair Manitou 2" pin dia	12516	350
2 x 5 x 48" pair New Holland 2.25" pin dia	12014	380
2 x 5 x 48" pair SkyTrak 2" pin dia	12516	350
2 x 5 x 48" pair Volvo 2" pin dia	12516	350
2 x 5 x 60" pair Cat 60mm pin dia	12020	460
2 x 5 x 60" pair JCB/NH 2.25 pin dia	14644	460
2 x 5 x 60" pair New Holland 2.25 pin dia	14644	460
2 x 5 x 72" pair Cat 60mm pin dia	12255	550
2 x 5 x 72" pair JCB 2.25" pin dia	12023	550
2 x 5 x 72" pair New Holland 2.25" pin dia	12023	550
2 x 5 x 72" pair JCB 2" pin dia	12480	550
2 x 5 x 72" pair Lull 844	12524	550

FLOATING PIN FORKS CONTINUED NEXT PAGE

FORKS - FLOATING PIN CONT.

FORKS - FLOATING PIN FOR TRACTOR LOADERS/BACKHOES CONT.

12,640 LB. LOAD-RATED FORKS (PAIR)	ORDER CODE	SHIP WEIGHT (LBS)
2 x 6 x 60" pair Gehl 2.50" pin dia	11838	570
2 x 6 x 72" pair Gehl 2.50" pin dia	11840	650



FORKS - FLOATING PIN FOR WHEEL LOADERS

6,860 LB. LOAD-RATED FORKS (PAIR)	ORDER CODE	SHIP WEIGHT (LBS)
1.75 x 4 x 48" pair JCB 2" pin	12367	280
1.75 x 4 x 60" pair JCB 520/523, 1.75" shaft	12309	280
1.75 x 4 x 84" pair JCB 520, 1.75" shaft	12411	280
1.75 x 4 x 84" pair SkyTrak, 2" shaft	12483	280

8,000 LB. LOAD-RATED FORKS (PAIR)	ORDER CODE	SHIP WEIGHT (LBS)
2 x 4 x 48" pair Cat 60mm pin dia	12252	340
2 x 4 x 48" pair Gehl 2" pin dia	12415	340
2 x 4 x 48" pair JCB 2.25" pin dia	12006	340
2 x 4 x 48" pair JCB 2" pin	12275	340
2 x 4 x 48" pair Lull 844B	12584	340
2 x 4 x 48" pair New Holland 2.25" pin dia	12006	340
2 x 4 x 60" pair JCB 2.25" pin dia	12009	350
2 x 4 x 60" pair JCB 2" pin dia	12413	350
2 x 4 x 60" pair New Holland 2.25" pin dia	12009	350
2 x 4 x 60" pair SkyTrak	12458	375

10,000 LB. LOAD-RATED FORKS (PAIR)	ORDER CODE	SHIP WEIGHT (LBS)
2 x 5 x 48" pair Volvo 2" pin dia	12516	380
2 x 5 x 60" pair Cat 60mm pin dia	12020	460
2 x 5 x 60" pair JCB 2.25 pin dia	14644	460
2 x 5 x 60" pair New Holland 2.25 pin dia	14644	460
2 x 5 x 72" pair Cat 60mm pin dia	12255	550
2 x 5 x 72" pair JCB/NH 2.25" pin dia	12023	550
2 x 5 x 72" pair JCB 2" pin dia	12480	550
2 x 5 x 72" pair Lull 844	12524	550

21,400 LB. LOAD-RATED FORKS (PAIR)	ORDER CODE	SHIP WEIGHT (LBS)
2.5 x 6 x 84" pair low back 2.25" pin dia	12593	1050

FORKS & CARRIAGES

HOOK ON FORKS



- Includes 2 forks - 1.5" x 4" x 48"
- 48" back height
- 72" fork shaft and 4 mounting lugs weld onto your bucket

HOOK ON FORKS FOR TRACTOR LOADERS/BACKHOES



	ORDER CODE	SHIP WEIGHT (LBS)
1.5 x 4 x 48" set 72" wide 5,400 lb cap	12519	390

ITA TINES



- Class I, II, III, and IV
- Sizes range from 48" to 96" depending on class

ITA FOR TRACTOR LOADERS/BACKHOES AND WHEEL LOADERS



	ORDER CODE	SHIP WEIGHT (LBS)
60" tines (6,200 lb.)	12678	300
72" tines (6,200 lb)	12509	380
Class III		
2 x 4 x 48" pair class III 8,000 lb cap	12452	364
2 x 4 x 60" pair class III 8,000 lb cap	12453	416
2 x 5 x 60" pair class III 10,000 lb cap	12660	460
2 x 5 x 72" pair class III 10,000 lb cap	12268	536

GRAPPLES



GRAPPLES

SHARKBITE™ GRAPPLE



- Fits all standard Class II ITA fork rails
- Field install is under 5 minutes with no tools
- High strength steel construction
- Powder coat finish
- Shark teeth and Forks sold separately

FORK-STYLE INSTALL

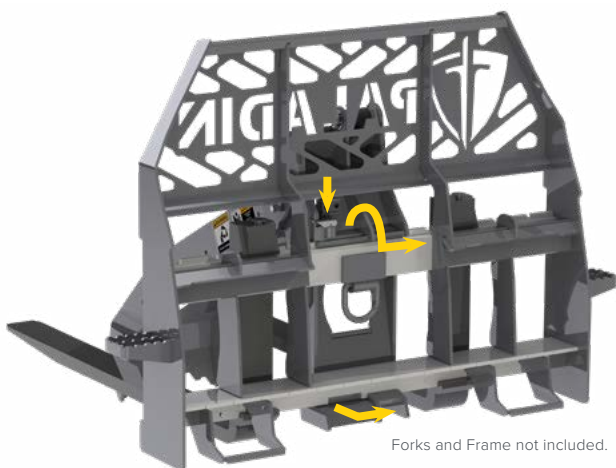

Forks and Frame not included.

MINIMUM LOAD DIAMETER	OVERALL HEIGHT	DEPTH	MINIMUM ENVELOPE	PASS-THRU	RANGE OF MOTION
14"	63.5"	46.5"	7.5"	7.5"	117°

SHARKBITE GRAPPLE™ FOR SKID-STEER LOADERS



SHARKBITE™ GRAPPLE (HOSES INCLUDED)	ORDER CODE	SHIP WEIGHT (LBS)
Sharkbite Grapple	233180	175

OPTIONS	ORDER CODE	SHIP WEIGHT (LBS)
Reversible AR400 hardened teeth (QTY 6 - Field install)	233215	

BRUSH GRAPPLES

HEAVY-DUTY BRUSH GRAPPLES (DUAL CYLINDER)

NEW PRODUCT



- 6" tine spacing
- Standard cylinder guards protect all cylinder components
- 1.25" cylinder pivot pins
- 1.25" x 24" full length grapple pins greatly reduce torsional force
- .375" end plates on Tractor Duty end plates and .5" end plates on Standard and Heavy Duty
- Cushioned and sleeved cylinders are 2" x 8" x 1.25"
- Standard load check valve
- 100,000 PSI tensile yield strength tines

Carrier Specifications	
Lift Capacity	Operating Weight
<5,000 lbs.	<9,500 lbs.

Specifications							
Model	Weight (approx)	Width	Depth	Grapple Opening	Grapple Closed	Tines	Tine Thickness
32172-0022	995 lbs	72"	39"	40"	29"	14	0.5"
32178-0022	1010 lbs	78"	39"	40"	29"	14	0.5"
32184-0022	1070 lbs	84"	39"	40"	29"	16	0.5"

HEAVY-DUTY BRUSH GRAPPLES FOR SKID-STEER LOADERS



INCLUDES: GRAPPLE, UNIVERSAL SSL MOUNTING AND HOSE/COUPLER KITS

HEAVY-DUTY BRUSH GRAPPLE	ORDER CODE	SHIP WEIGHT (LBS)
72" heavy-duty brush grapple	32172-0022	925
78" heavy-duty brush grapple	32178-0022	999
84" heavy-duty brush grapple	32184-0022	1054

OPTIONS	ORDER CODE	SHIP WEIGHT (LBS)
Stop Kit - John Deere G-Series* * Stops to be used on John Deere G-Series to prevent hydraulic coupler interference.	239072	6

GRAPPLES

BRUSH GRAPPLES

HEAVY-DUTY BRUSH GRAPPLE (DUAL CYLINDER)

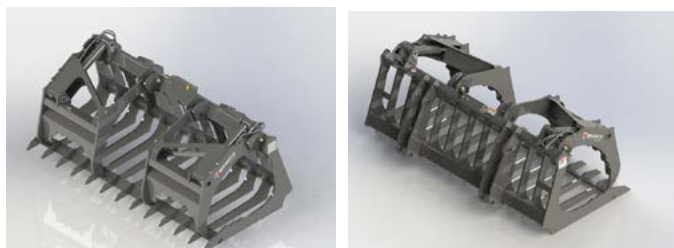

- 84" wide
- Dual independent see through grapples
- Cylinder protection
- Hydraulic hose protection

HEAVY-DUTY BRUSH GRAPPLE FOR TRACTOR LOADERS/ BACKHOES AND WHEEL LOADERS



	ORDER CODE	SHIP WEIGHT (LBS)
78" Heavy Duty brush grapple, Universal SSL Hitch	236349	1529
84" Heavy Duty brush grapple, Universal SSL Hitch	236341	1552
98" Heavy Duty brush grapple, Universal SSL Hitch	236344	1683
Case 570LXT/MXT, 580L/M & SL/SM pin on	101040	1654
Cat IT / TH	13067	1654
John Deere 210LE pin on	13004	1725
JCB 506/508	12726	1520
JCB Q-fit	12867	1823
New Holland LB75 Pin-on Mtg 1800	13212	1800
New Holland LM 640 - Versattach	12867	1823
QCP7000 interchange	13127	1785

STANDARD-DUTY BRUSH GRAPPLE (SINGLE CYLINDER)



- Aggressive grapples made of high strength steel for maximum performance and durability
- Cylinder guard design protects cylinder while preventing build-up of debris
- Provides excellent visibility

Specifications					
Model	Width	Weight (approx)	Height Open	Height Closed	Length
108597	48"	300 lbs	29"	25.5"	30.5"
108598	54"	315 lbs	29"	25.5"	30.5"
108415	72"	435 lbs	29"	25.5"	30.5"

STANDARD-DUTY BRUSH GRAPPLE FOR COMPACT TRACTORS



HOSES & COUPLERS NOT INCLUDED	ORDER CODE	SHIP WEIGHT (LBS)
48" brush grapple (single cylinder)	108597	300
54" brush grapple (single cylinder)	108598	315
72" brush grapple (dual cylinder)	108415	435
Options		
48" bolt-on bar assembly	107158	26

BRUSH GRAPPLES

STANDARD-DUTY BRUSH GRAPPLE (DUAL CYLINDER)



NEW PRODUCT

- Open floor design
- Features grapple pins and cushioned cylinders
- 80,000 PSI tensile yield strength tines
- Available in 60", 66" and 72" widths

Carrier Specifications	
Lift Capacity	Operating Weight
<4,000 lbs.	<6,500 lbs.

Specifications							
Model	Weight (approx)	Width	Depth	Grapple Opening	Grapple Closed	Tines	Tine Thickness
32060-0022	668 lbs	60"	36"	33"	29"	9	0.4"
32066-0022	696 lbs	66"	36"	33"	29"	10	0.4"
32072-0022	724 lbs	72"	36"	33"	29"	11	0.4"
32084-0022	817 lbs	84"	36"	33"	29"	13	0.4"



STANDARD-DUTY BRUSH GRAPPLE (DUAL CYLINDER) FOR SKID-STEER LOADERS



INCLUDES: GRAPPLE, UNIVERSAL SSL MOUNTING AND HOSE/COUPLER KITS

GRAPPLE ASSEMBLIES	ORDER CODE	SHIP WEIGHT (LBS)
60" standard-duty brush grapple	32060-0022	668
66" standard-duty grapple	32066-0022	696
72" standard-duty grapple	32072-0022	724
84" standard-duty grapple	32084-0022	817

OPTIONS	ORDER CODE	SHIP WEIGHT (LBS)
Load check valve	239168	

GRAPPLES

SCRAP GRAPPLES

HEAVY-DUTY SCRAP GRAPPLES (DUAL CYLINDER)



- Standard cylinder guards protect all cylinder components
- Standard load check valve
- 1.25" cylinder pivot pins with spherical bearings
- 1.25" x 24" full length grapple pins reduce torsional force
- Cushioned cylinders are 2" x 8" x 1.25"
- Optional, reversible .75" x 8" double bevelled edge
- Secluded grease zerks protects from damage

Specifications					
Model	Weight (approx)	Width	Depth	Grapple Open	Grapple Closed
11876-0022	1081 lbs	77"	39"	40"	29"
11882-0022	1133 lbs	83"	39"	40"	29"
11888-0022	1180 lbs	89"	39"	40"	29"

HEAVY-DUTY SCRAP GRAPPLES FOR SKID-STEER LOADERS



**INCLUDES: GRAPPLE AND UNIVERSAL SSL MOUNTING
TO ORDER: CHOOSE GRAPPLE AND HOSE COUPLER KIT**

HEAVY-DUTY SCRAP GRAPPLE - KITS	ORDER CODE	SHIP WEIGHT (LBS)
76" heavy-duty scrap grapple, 88" hoses included, bolt-on edge included	123671	1202
82" heavy-duty scrap grapple, 88" hoses included, bolt-on edge included	123672	1253
88" heavy-duty scrap grapple, 88" hoses included, bolt-on edge included	123673	1297

HEAVY-DUTY SCRAP GRAPPLE	ORDER CODE	SHIP WEIGHT (LBS)
76" heavy-duty scrap grapple	11876-0022	1081
82" heavy-duty scrap grapple	11882-0022	1133
88" heavy-duty scrap grapple	11888-0022	1180

HOSE/COUPLER KIT	ORDER CODE	SHIP WEIGHT (LBS)
Required for Heavy-Duty Grapples		
60" Hose Kit	MTG1113-0022	14
80" Hose Kit	MTG1113-0903	18
80" Hose Kit with 90° couplers (use for Bobcat M Series)	MTG1113-0319	20
88" Hose Kit	MTG1113-9783	21
96" Hose Kit	117285	23

OPTIONAL REVERSIBLE CUTTING EDGE KIT	ORDER CODE	SHIP WEIGHT (LBS)
76" bolt-on edge for construction grapple	11800	
82" bolt-on edge for construction grapple	15029	
88" bolt-on edge for construction grapple	11801	
Option: Side plate extension (Customer to drill holes)	LAF5250-0000	

SCRAP GRAPPLES

MODEL 120 STANDARD-DUTY SCRAP GRAPPLE (DUAL CYLINDER)



- The strength and design of the Model 120 grapple make it the ideal attachment for scrap yards, recycling and construction sites
- Features grapple pins
- Optional bolt on edges, cushioned cylinders, hardened pins and cylinder and hose guards available

Carrier Specifications	
Lift Capacity	Operating Weight
<9,000 lbs.	<11,000 lbs.

Specifications					
Model #	Weight	Width ID	Open	Closed	Depth
LAF5073	1,266 lbs	74"	45.4"	19.1"	37.8"
LAF5078	1,301 lbs	79"	45.4"	19.1"	37.8"
LAF5082	1,329 lbs	83"	45.4"	19.1"	37.8"
LAF5087	1,364 lbs	88"	45.4"	19.1"	37.8"
LAF5273	1,303 lbs	74"	45.4"	19.1"	37.8"
LAF5278	1,514 lbs	79"	45.4"	19.1"	37.8"
LAF5282	1,542 lbs	83"	45.4"	19.1"	37.8"
LAF5287	1,577 lbs	88"	45.4"	19.1"	37.8"



IMPORTANT: All wheel loaders must have an OEM supplied flow limiter/reducer type valve installed on the tilt circuit. All replacement hydraulic hoses and fittings must have a minimum rated working pressure of 4000 psi.

MODEL 120 STANDARD-DUTY SCRAP GRAPPLES FOR SKID-STEER LOADERS



INCLUDES: GRAPPLE, UNIVERSAL SSL MOUNTING, 78" HOSES AND 1/2" BODY QD'S
TO ORDER: CHOOSE GRAPPLE AND MOUNTING

STANDARD FEATURED GRAPPLE BUCKET CHECK LOADER CAPACITY BEFORE ORDERING		ORDER CODE	SHIP WEIGHT (LBS)
Includes Cushioned Cylinders			
74" ID Scrap Grapple Bucket		LAF5073-0022	1266
79" ID Scrap Grapple Bucket		LAF5078-0022	1301
83" ID Scrap Grapple Bucket		LAF5082-0022	1329
88" ID Scrap Grapple Bucket		LAF5087-0022	1364
FULL FEATURED GRAPPLE BUCKET CHECK LOADER CAPACITY BEFORE ORDERING		ORDER CODE	SHIP WEIGHT (LBS)
Includes Cushioned Cylinder Kit, Hardened Pin and Cylinder/Hose Guard			
74" ID Scrap Grapple Bucket		LAF5273-0022	1303
79" ID Scrap Grapple Bucket		LAF5278-0022	1514
83" ID Scrap Grapple Bucket		LAF5282-0022	1542
88" ID Scrap Grapple Bucket		LAF5287-0783	1577

MODEL 120 SCRAP GRAPPLE CONTINUED NEXT PAGE

GRAPPLES

SCRAP GRAPPLES

MODEL 120 STANDARD-DUTY SCRAP GRAPPLE (DUAL CYLINDER)

MODEL 120 STANDARD-DUTY SCRAP GRAPPLES FOR SKID-STEER LOADERS CONT.

GRAPPLES

MOUNTING	ORDER CODE	SHIP WEIGHT (LBS)
Contact Customer Service at (833) 723-1843		

OPTIONS - REVERSIBLE CUTTING EDGE KIT	ORDER CODE	SHIP WEIGHT (LBS)
includes BOE, grade 8 plow bolts, lock washers & nuts		
For LAF5073 & LAF5273 (7 holes, 11" spacing)	15028	120
For LAF5078 & LAF5278 (9 holes, 9" spacing)	16204	130
For LAF5082 & LAF5282 (9 holes, 9.75" spacing)	15029	136
For LAF5087 & LAF5287 (14 holes, 6" spacing)	113978	168
Accessories (Add-ons or replacement parts)		
Cylinder/Hose Guard Kit for Model 120	LAF5004-0000	57
End Plate Extensions - Full Kit for Model 120 & construction	LAF5250-0000	30

NOTE: Field installation required on hardened pin, and cylinder hose guard kits

TOOTHBARS - *Exclusive to FFC Buckets		
Heavy-Duty Toothbar for Buckets without Bolt-On Edge		
For LAF5073 & LAF5273 with 8 teeth	10543	127
For LAF5082 & LAF5282 with 10 teeth	10569	151
Heavy-Duty Toothbar for Buckets with Bolt-On Edge		
For LAF5078 & LAF5278 with 8 teeth	10554	159
For LAF5082 & LAF5282 with 10 teeth	10570	186
Extra Heavy-Duty Toothbar for Buckets without Bolt-On Edge		
For LAF5073 & LAF5273 with 8 teeth	10607	129

SCRAP GRAPPLES

HEAVY-DUTY SCRAP GRAPPLE (DUAL CYLINDER)

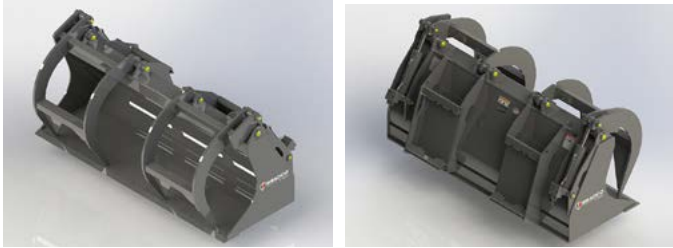

- Abrasion resistant cutting edge with punched holes for optional bolt on edges
- Cut away side plate
- Dual arms with po checks to grab uneven loads

HEAVY-DUTY SCRAP GRAPPLE FOR TRACTOR LOADERS/BACKHOES



		ORDER CODE	SHIP WEIGHT (LBS)
.78 YD SCRAP GRAPPLE			
JCB 210S/212S 75" wide	edge group 100831	11509	1350
1.00 YD SCRAP GRAPPLE			
JCB 520 78" wide	edge group 12597	11850	1284
JCB 520 & 524 88" wide	edge group 24508	12783	1550
Manitou 90" wide	edge group 12297	12773	1375
Universal Hitch 73" wide	edge group 15025	13134	1130
1.25 YD SCRAP GRAPPLE			
New Holland LB90/110 90" wide	edge group C	12405	1693
1.75 YD SCRAP GRAPPLE			
Cat IT/TH	edge group A	12439	1800
Gehl DynacARRIER	edge group B	12741	1750
Gradall G6-42A		12700	1690
Manitou hitch		12847	1700
SkyTrak	edge group B	12759	1800
2.50 YD SCRAP GRAPPLE			
Cat IT/TH	edge group A	15201	2440

HEAVY-DUTY SCRAP GRAPPLE FOR WHEEL LOADERS



		ORDER CODE	SHIP WEIGHT (LBS)
.78 YD SCRAP GRAPPLE			
JCB 409 old style with edge 78" wide		12434	1350
1.00 YD SCRAP GRAPPLE			
Cat 902/906/908 88" wide	edge group 24508	11053	1550
Case 221D/321D 88" wide	edge group 24508	12512	1572
JCB 407/409 88" wide 1.25 yd	edge group 24508	12738	1875
JCB 75" wide 407 / 409A	edge group 14989	12719	1650
Komatsu WA65 / 75 / 85 / 95	edge group 14989	12719	1650
New Holland LW80 88" wide	edge group 24508	12512	1572
Universal Hitch 73" wide	edge group 15025	13134	1130
1.75 YD SCRAP GRAPPLE			
Case 521 D pin on	edge group A	13028	2025
2.50 YD SCRAP GRAPPLE			
Cat IT14/IT24 96" wide	edge group A	12311	3000
JRB 416 series lugs 2.25 yd		12723	3050

GRAPPLES

SCRAP GRAPPLES

MODEL 130 HEAVY-DUTY SCRAP GRAPPLE BUCKET



- 1.5" x 27.125" grapple pins reduce torsional force
- 1.5" x 8.625" heat-treated, greaseable pivot pins
- Optional cushioned and sleeved cylinders: 2.5" x 8"x 1.75"
- Bucket edge drilled for FFC replaceable edge unless specified

Carrier Specifications	
Lift Capacity	Operating Weight
<10,000 lbs.	<18,000 lbs.

Specifications						
Model	Weight (approx)	Width ID	Open	Closed	Depth	Cubic Yards
LAF5283	1,665 lbs	83"	47.4"	21.8"	37.3"	1 yd ³
LAF5294	1,745 lbs	94"	47.4"	21.8"	37.3"	1.25 yd ³



IMPORTANT: All wheel loaders must have an OEM supplied flow limiter/reducer type valve installed on the tilt circuit. All replacement hydraulic hoses and fittings must have a minimum rated working pressure of 4000 psi.

MODEL 130 SCRAP GRAPPLE BUCKET FOR TRACTOR LOADERS/ BACKHOES AND WHEEL LOADERS



**INCLUDES: GRAPPLE , PRICE OF LOADER MOUNTING MUST BE ADDED TO ATTACHMENT PRICE
TO ORDER: CHOOSE GRAPPLE AND MOUNTING**

GRAPPLE BUCKET	ORDER CODE	SHIP WEIGHT (LBS)
CHECK LOADER CAPACITY BEFORE ORDERING		
83" ID Scrap Grapple Bucket	LAF5283	1665
94" ID Scrap Grapple Bucket	LAF5294	1745

OPTIONAL - REVERSIBLE CUTTING EDGE KIT	ORDER CODE	SHIP WEIGHT (LBS)
INCLUDES BOE, GRADE 8 PLOW BOLTS, LOCK WASHERS & NUTS		
For LAF5283 (9 holes, 9.75" spacing)	15029	NA
For LAF5294 (15 holes, 6" spacing)	FFC10083	195
For Optional Bolt-On Edge Drill Patterns (i.e. Case Hole Patterns) - Call (833) 723-1843		

OPTIONS	ORDER CODE	SHIP WEIGHT (LBS)
Heavy-Duty Toothbar for Buckets without Bolt-On Edge - Exclusive to FFC Buckets		
For LAF5283 with 10 teeth	10569	151
Heavy-Duty Toothbar for Buckets with Bolt-On Edge - Exclusive to FFC Buckets		
For LAF5283 with 10 teeth	10570	186

FOR CUSTOM TOOTHBARS OR TOOTHBARS WITHOUT FFC BOLT-ON EDGE - CALL (833) 723-1843
SEE TOOTHBAR SECTION FOR CUSTOM TOOTHBAR OPTIONS

End Plate Extension - Full Kit for Model 130	LAF5252-0000	50
--	--------------	----

NOTE: Field installation required on hardened pin, cushioned cylinder and cylinder hose guard kits

SCRAP GRAPPLES

STANDARD-DUTY SCRAP GRAPPLE (DUAL CYLINDER)



- Standard cylinder guards protect all cylinder components
- Standard load check valve
- 1.25" cylinder pivot pins with spherical bearings
- 1.25" x 24" full length grapple pins reduce torsional force
- Cushioned cylinders are 2" x 8" x 1.25"
- Optional, reversible .75" x 8" double bevelled edge
- Secluded grease zerks protects from damage

Specifications					
Model	Weight (approx)	Width	Depth	Grapple Open	Grapple Closed
12860-0022	738 lbs	61"	34"	34"	29"
12866-0022	788 lbs	67"	34"	34"	29"
12872-0022	835 lbs	73"	34"	34"	29"



STANDARD-DUTY SCRAP GRAPPLE (DUAL CYLINDER) FOR SKID-STEER LOADERS

GRAPPLE ASSEMBLIES	ORDER CODE	SHIP WEIGHT (LBS)
Standard-Duty Scrap Grapple Assembly (hose/coupler kit is not included)		
60" standard-duty scrap grapple	12860-0022	738
66" standard-duty scrap grapple	12866-0022	788
72" standard-duty scrap grapple	12872-0022	835

HOSE/COUPLER KIT	ORDER CODE	SHIP WEIGHT (LBS)
Required for Utility Grapples		
60" Hose Kit	MTG1113-0022	14
80" Hose Kit	MTG1113-0903	18
80" Hose Kit with 90° couplers (use for Bobcat M Series)	MTG1113-0319	20
88" Hose Kit	MTG1113-9783	21
96" Hose Kit	117285	23

OPTIONAL REVERSIBLE CUTTING EDGE KIT	ORDER CODE	SHIP WEIGHT (LBS)
60" bolt-on edge for utility grapple	15025	98
66" bolt-on edge for utility grapple	15027	108
72" bolt-on edge for utility grapple	15028	117

GRAPPLES

SCRAP GRAPPLE BUCKET

- Available in 60", 66", and 72" widths
- Low profile sides to allow longer pieces of scrap or debris in the bucket

SCRAP GRAPPLE BUCKET FOR COMPACT TRACTORS



	ORDER CODE	SHIP WEIGHT (LBS)
60" scrap grapple bucket	10705-60-0822	
66" scrap grapple bucket	10705-66-0822	
72" scrap grapple bucket	10705-72-0822	

LOG GRAPPLE



- Excellent attachment for handling logs, pipes, brush, and other bulky materials
- 2" x 8" hydraulic cylinder
- Closes to 6" log or pipe

Carrier Specifications	
Lift Capacity	Operating Weight
<10,000 lbs.	<20,000 lbs.

Specifications							
Model	Weight (approx)	Lift Capacity	Height OD	Depth	Usable Tooth	Grapple Open	Tine Length
LAF1142	790 lbs	6,400 lbs	48.6"	37.85"	28.4"	49.3"	29"

LOG GRAPPLE FOR SKID-STEER LOADERS



INCLUDES: LOG GRAPPLE, UNIVERSAL SSL MOUNTING, AND HOSES AND COUPLERS
TO ORDER: CHOOSE GRAPPLE AND MOUNTING

LOG GRAPPLE	ORDER CODE	SHIP WEIGHT (LBS)
CHECK LOADER CAPACITY BEFORE ORDERING		
Log Grapple 42" tines	LAF1142-0022	790

MOUNTING	ORDER CODE	SHIP WEIGHT (LBS)
ADDITIONAL COST MAY APPLY		
Contact Customer Service at (833) 723-1843		

SKELETON FORK & GRAB



- Easy handling of scrap pallets and yard waste in recycling applications
- Designed for tub grinder charging
- Open tines allow dirt to drop out, which increases tub grinder life

SKELETON FORK & GRAB FOR WHEEL LOADERS



	ORDER CODE	SHIP WEIGHT (LBS)
Cat IT/TH	12161	2335
Cat IT/TH with enclosed sides	12510	2445

TRASH CLAMP



- Single grapple to hold paper waste inside the bucket
- Designed to clamp and hold loose material
- Works well with any loose material needing secured for transporting or loading

TRASH CLAMP FOR WHEEL LOADERS



	ORDER CODE	SHIP WEIGHT (LBS)
1.75 YD TRASH CLAMP (GRAPPLE)		
JCB 416HT	edge group B	12537
		1625

GRAPPLES

LAND SCULPTOR



- Levels all types of soil by cutting high spots & filling depressions
- Can be used as a carry-all
- Optional comb breaks up dirt chunks & smooths surface
- Optional scarifiers dig into packed dirt

LAND SCULPTOR FOR SKID-STEER LOADERS



	ORDER CODE	SHIP WEIGHT (LBS)
78" land sculptor assembly	106400	515
Options		
comb assembly	106379	109
scarifier tooth assembly	107009	59
bolt-on cutter bar	16204	127

FORK MOUNTED CRANE HOOK

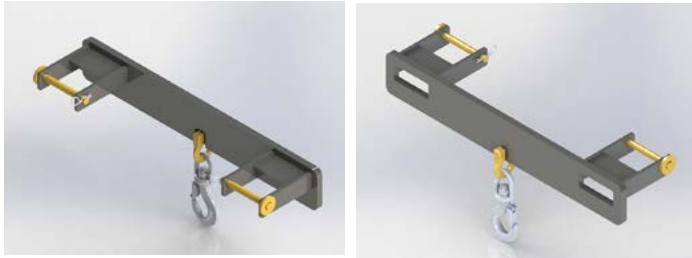

- 4,000 to 10,000 lb capacities
- Swivel hook with safety latch
- Fork mounted for easy use
- Excellent utility tool

FORK MOUNTED CRANE HOOK FOR TELEHANDLERS AND TRACTOR LOADERS/BACKHOES



	ORDER CODE	SHIP WEIGHT (LBS)
4,000 lb	11985	104
10,000 lb	12398	122

LIFTING HOOK



- 12,000 lb capacity

LIFTING HOOK FOR TELEHANDLERS



	ORDER CODE	SHIP WEIGHT (LBS)
Case 688	19716	230
Cat IT/TH	12971	219
Ingersoll Rand VR642-1056	19716	230
JLG "G" series	12992	224
John Deere 310 QA	119134	435
Manitou (serial # <0160037670)	13094	276
New Holland LM-A	13094	276

HYDRAULICS

AUXILIARY HYDRAULIC CONVERSION KIT

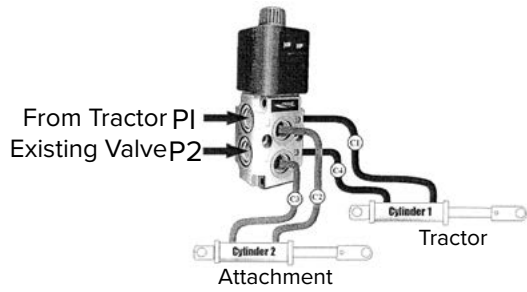

- Converts existing tractor loader to two-function hydraulics



AUXILIARY HYDRAULIC CONVERSION KIT FOR COMPACT TRACTORS

	ORDER CODE	SHIP WEIGHT (LBS)
converts existing tractor loader to two-function hydraulics	109052	45

MANURE PUSH



- Ideal for waste water, manure, feed lots, flood clean-up
- Moves large volumes of snow efficiently
- Rubber edge 1 ft x 6" on scraper & pull back

Specifications				
Model	Width (overall)	Height (overall)	Depth (overall)	Weight (lbs)
10711-60	60"	28"	29"	227
10711-72	72"	28"	29"	313
10711-84	84"	28"	29"	349
10711-96	96"	28"	29"	385

MANURE PUSH FOR COMPACT TRACTORS



	ORDER CODE	SHIP WEIGHT (LBS)
60" manure push	10711-60-0822	227
72" manure push	10711-72-0822	313
84" manure push	10711-84-0822	349
96" manure push	10711-96-0822	385

MINI ATTACHMENTS



MINI ATTACHMENTS

MINI ATTACHMENTS FOR COMPACT TOOL CARRIERS AND MINI SKID-STEER LOADERS



MINI ADAPTERS

- For universal attachment & 3 point
- Weld-on adapters available
- Tilt attach adapters available



UNIVERSAL ATTACHMENT	ORDER CODE	SHIP WEIGHT (LBS)
For Use On Machine Listed		
ASV/Polaris to mini attachment	2003866	100
Bobcat MT50/52 to mini attachment	18193	150
New Holland LS120/LS125 to mini attachment	19541	65
Thomas 85 to mini attachment	2006646	75
3-point Cat I to mini attachment	101160	52
mini universal to Bobcat MT50/52 attachments	103633	71
mini skid steer to skid steer loader universal adapter	123794	164
WELD-ON ADAPTER	ORDER CODE	SHIP WEIGHT (LBS)
universal hitch	31629	29
ASV/Polaris	16647	62
Bobcat MT50/52	16142	74
Gehl	17699	25
New Holland LS120/LS125	23973	30
Thomas 85	2006645	37
weld to your attachment for mounting to mini-skid listed		
TILT ATTACH ADAPTER	ORDER CODE	SHIP WEIGHT (LBS)
mini universal tilt attach includes hoses & flat face couplers	100145	94
Bobcat MT50/52 to mini universal mount	103246	160

MINI ATTACHMENTS FOR COMPACT TOOL CARRIERS AND MINI SKID-STEER LOADERS

NEW PRODUCT

CS SERIES MINI AUGER DRIVES



- Advanced gearing standard for increased life and efficiency
- Secure lock shaft
- Compact housing design for easy handling and increased strength and durability
- Oversized bearing for improved load handling
- Extreme shaft seals for reduced service intervals
- Compact, high torque, efficient hydraulic motors for improved drilling productivity
- Easy access service points for user friendly maintenance
- Full connection contact between auger hub and auger drive unit

CS SERIES AUGER DRIVES FOR COMPACT TOOL CARRIERS



INCLUDES: AUGER DRIVE ONLY. YOU MUST ORDER MOUNTING KIT, AUGER BITS, AND EXTENSIONS SEPARATELY.

CS SERIES AUGER DRIVES		ORDER CODE	SHIP WEIGHT (LBS)
Hose routed out the side			
CS 11-12 2.56" Round Auger Drive, 0.8 - 2 MT		810231N	130
CS 11-12 2" Hex Auger Drive, 0.8 - 2 MT		810232N	130
CS 16-15 2.56" Round Auger Drive, 1 - 2.5 MT		810237N	130
CS 16-15 2" Hex Auger Drive, 1 - 2.5 MT		810238N	130
CS 20-17 2.56" Round Auger Drive, 2 - 3 MT		810243N	130
CS 20-17 2" Hex Auger Drive, 2 - 3 MT		810244N	130
MOUNT		ORDER CODE	SHIP WEIGHT (LBS)
CII Mount Assembly		239280	111
MT50/52/100 CTC Mount Assembly		239283	157

CS SERIES KITTED BUNDLES FOR COMPACT TOOL CARRIERS



INCLUDES: MOUNT, DRIVE, AND SELECT BUNDLES INCLUDE QUICK DISCONNECT FITTINGS. SEE TABLE FOR PROPER OUTPUT SHAFT AND DETAILS.

CTC MOUNT BUNDLES					
Hose routed out the side					
ORDER CODE	DESCRIPTION	OUTPUT SHAFT	MOUNT	QD INCLUDED	SHIP WEIGHT (LBS)
810237N-0961	CS 16-15 AUGER DRIVE	2.563 IN ROUND	CII	1/2	181
810238N-0961	CS 16-15 AUGER DRIVE	2 IN HEX	CII	1/2	181
810243N-0961	CS 20-17 AUGER DRIVE	2.563 IN ROUND	CII	1/2	181
810244N-0961	CS 20-17 AUGER DRIVE	2 IN HEX	CII	1/2	181
810237N-0128	CS 16-15 AUGER DRIVE	2.563 IN ROUND	Bobcat	1/2	181
810238N-0128	CS 16-15 AUGER DRIVE	2 IN HEX	Bobcat	1/2	181
810243N-0128	CS 20-17 AUGER DRIVE	2.563 IN ROUND	Bobcat	1/2	181
810244N-0128	CS 20-17 AUGER DRIVE	2 IN HEX	Bobcat	1/2	181

MINI ATTACHMENTS

MINI ATTACHMENTS FOR COMPACT TOOL CARRIERS AND MINI SKID-STEER LOADERS



MINI AUGERS CONT.

AUGER BITS	ORDER CODE
3' Aggressor Augers 2" Hex	
6" x 3' aggressor auger 2" hex	236011
9" x 3' aggressor auger 2" hex	236012
12" x 3' aggressor auger 2" hex	236013
15" x 3' aggressor auger 2" hex	236014
18" x 3' aggressor auger 2" hex	236015
24" x 3' aggressor auger 2" hex	243160
30" x 3' aggressor auger 2" hex	243161
36" x 3' aggressor auger 2" hex	243162
3' Aggressor Augers 2.56" Round	
6" x 3' aggressor auger 2.56" round	236016
9" x 3' aggressor auger 2.56" round	236017
12" x 3' aggressor auger 2.56" round	236018
15" x 3' aggressor auger 2.56" round	236019
18" x 3' aggressor auger 2.56" round	236020
24" x 3' aggressor auger 2.56" round	243163
30" x 3' aggressor auger 2.56" round	243164
36" x 3' aggressor auger 2.56" round	243165
3' Trimax Augers 2" Hex	
6" x 3' trimax auger 2" hex	243166
9" x 3' trimax auger 2" hex	243167
12" x 3' trimax auger 2" hex	243168
16" x 3' trimax auger 2" hex	243169
18" x 3' trimax auger 2" hex	243170
24" x 3' trimax auger 2" hex	243171
30" x 3' trimax auger 2" hex	243172
36" x 3' trimax auger 2" hex	243173

AUGER BITS	ORDER CODE
3' Trimax Augers 2.56" Round	
6" x 3' trimax auger 2.56" round	243174
9" x 3' trimax auger 2.56" round	243175
12" x 3' trimax auger 2.56" round	243176
16" x 3' trimax auger 2.56" round	243177
18" x 3' trimax auger 2.56" round	243178
24" x 3' trimax auger 2.56" round	243179
30" x 3' trimax auger 2.56" round	243180
36" x 3' trimax auger 2.56" round	243181
3' Mini Aggressor Augers 2.56" Round	
6" x 3' aggressor auger 2.56" round	243187
9" x 3' aggressor auger 2.56" round	243188
12" x 3' aggressor auger 2.56" round	243189
15" x 3' aggressor auger 2.56" round	243190
18" x 3' aggressor auger 2.56" round	243191
3' Mini Aggressor Augers 2" Hex	
6" x 3' aggressor auger 2" hex	243182
9" x 3' aggressor auger 2" hex	243183
12" x 3' aggressor auger 2" hex	243184
15" x 3' aggressor auger 2" hex	243185
18" x 3' aggressor auger 2" hex	243186

MINI ATTACHMENTS FOR COMPACT TOOL CARRIERS AND MINI SKID-STEER LOADERS

MINI ANGLE BROOM (SWEEPER)



- 26" diameter brush heads
- 42", 48", and 60" widths
- Polypropylene and mixed poly/wire brushes available
- Optional dirt deflectors
- Single direction is standard



Note: The sweeper is mounted to, and raised by the loader arms. The brush is powered from the Compact Tool Carrier 3rd function valve. There is a 10-16 GPM hydraulic flow required at 2000-2500 PSI. For Compact Tool Carriers with lift capacity under 1300 lbs.



INCLUDES: 26" DIAMETER BRUSH, WITH QUICK-CHANGE CORE, UNIVERSAL MINI MOUNTING, CONTROL BOX WITH POWER LEAD, AND MANUAL ANGLE AS STANDARD EQUIPMENT.



MINI ANGLE BROOM (SWEEPER)	ORDER CODE	SHIP WEIGHT (LBS)
BRUSH HEAD AND BRUSH MATERIAL		
26" Diameter Brush Heads - All Polypropylene Brush GPM Range 4-8		
CTC26 42" hydraulic sweeper	22641PM-0961	340
CTC26 48" hydraulic sweeper	22647PM-0961	380
26" Diameter Brush Heads - Mixed Polypropylene & Wire Brush GPM Range 4-8		
CTC26 42" hydraulic sweeper	22641MM-0961	340
CTC26 48" hydraulic sweeper	22647MM-0961	380
26" Diameter Brush Heads - All Polypropylene Brush GPM Range 6-12		
CTC26 42" hydraulic sweeper	22642PM-0961	340
CTC26 48" hydraulic sweeper	22648PM-0961	380
CTC26 60" hydraulic sweeper	22660PM-0961	440
26" Diameter Brush Heads - Mixed Polypropylene & Wire Brush GPM Range 6-12		
CTC26 42" hydraulic sweeper	22642MM-0961	340
CTC26 48" hydraulic sweeper	22648MM-0961	380
CTC26 60" hydraulic sweeper	22660MM-0961	440
ANGLE TYPE MANUAL OR HYDRAULIC (ONE REQUIRED)		
manual angle change	M	n/a
hydraulic angle change with electric valve - 12 volt	H	22
Hydraulic Angle Change with Electric Valve Control Options - For Replacement		
Control box w/ power lead	28-10754	5
MOUNTING (ONE REQUIRED)		
Contact Customer Service for correct mount for your CTC make and model - (833) 723-1843		n/a
OPTIONS		
conversion kit manual to hydraulic with box	11-5433	15
conversion kit manual to hydraulic without box	11-4191	6
Side Mount Caster Wheels		
side mount caster wheels S26	28-10498	45

MINI ATTACHMENTS

MINI ATTACHMENTS FOR COMPACT TOOL CARRIERS AND MINI SKID-STEER LOADERS

NEW PRODUCT

MINI DIRT BUCKETS



HEAVY DUTY

Carrier Specifications
Lift Capacity
Standard Duty - 1500 lbs.
Heavy Duty - 2500 lbs.

- Optional Bolt on Edge, Tooth Bar, and Teeth
- Wear resistant high carbon cutter edge standard
- HD Reinforcement Box Structures for increased durability
- 3/16" thick Grade 50 steel body
- Wear bars on the underside

MINI DIRT BUCKETS	ORDER CODE	SHIP WEIGHT (LBS)
Standard Duty Mini Dirt Buckets		
34.5" (5.8 ft ³) CII mount	233282	213
36" (6 ft ³) CII mount	233099	218
42" (7.3 ft ³) CII mount	233103	240
48" (8.3 ft ³) CII mount	233290	261
36" (6 ft ³) Bobcat mount	233284	222
42" (7.3 ft ³) Bobcat mount	233101	249
48" (8.3 ft ³) Bobcat mount	233288	269
Heavy Duty Mini Dirt Buckets		
48" (9.3 ft ³) SSL mount	233110	303
54" (10.5 ft ³) SSL mount	233115	325
60" (11.8 ft ³) SSL mount	233123	346
48" (9.3 ft ³) CII mount	233263	267
54" (10.5 ft ³) CII mount	233111	289
60" (11.8 ft ³) CII mount	233119	311



OPTIONS	ORDER CODE	SHIP WEIGHT (LBS)
34.5" bolt on edge	233093	
36" bolt on edge	107156	
42" bolt on edge	107157	
48" bolt on edge	107158	
54" bolt on edge	233268	
60" bolt on edge	233269	
34.5" bolt on tooth bar kit	119492	
36" bolt on tooth bar kit	120712	
42" bolt on tooth bar kit	2001065	
48" bolt on tooth bar kit	18200	
54" bolt on tooth bar kit	124965	
60" bolt on tooth bar kit	236346	
34.5" bolt on tooth kit (4 required)	233266	
36" bolt on tooth kit (4 required)	233266	
42" bolt on tooth kit (5 required)	233266	
48" bolt on tooth kit (5 required)	233266	
54" bolt on tooth kit (6 required)	233266	
60" bolt on tooth kit (7 required)	233266	

MINI ATTACHMENTS FOR COMPACT TOOL CARRIERS AND MINI SKID-STEER LOADERS

NEW PRODUCT

MINI LIGHT MATERIAL BUCKETS



HEAVY DUTY

Carrier Specifications
Lift Capacity
Light Duty - 750 lbs.
Standard Duty - 1500 lbs.
Heavy Duty - 2500 lbs.

- Optional Bolt on Edge and Teeth
- Wear resistant high carbon cutter edge standard
- HD Reinforcement Box Structures for increased durability
- 3/16" thick Grade 50 steel body
- Wear bars on the underside

MINI LIGHT MATERIAL BUCKETS	ORDER CODE	SHIP WEIGHT (LBS)
Light Duty Light Material Buckets		
34.5" (3.5 ft ³) CII mount	18741	172
36" (4 ft ³) CII mount	117506	175
42" (4 ft ³) CII mount	2000872	192
48" (6 ft ³) CII mount	2000877	240
Standard Duty Light Material Buckets		
36" (11.4 ft ³) CII mount	233151	244
42" (13.5 ft ³) CII mount	233148	269
48" (15.6 ft ³) CII mount	233157	293
36" (11.4 ft ³) Bobcat mount	233159	273
42" (13.5 ft ³) Bobcat mount	233161	303
48" (15.6 ft ³) Bobcat mount	233163	325
Heavy Duty Light Material Buckets		
48" (15.6 ft ³) CII mount	233129	313
54" (17.6 ft ³) CII mount	233145	338
48" (15.6 ft ³) SSL mount	233165	350
54" (17.6 ft ³) SSL mount	236244	375
60" (23.3 ft ³) SSL mount	236245	435
68" (27.1 ft ³) SSL mount	236246	469



OPTIONS	ORDER CODE	SHIP WEIGHT (LBS)
36" bolt on edge	107156	
42" bolt on edge	107157	
48" bolt on edge	107158	
54" bolt on edge	233268	
60" bolt on edge	233269	
68" bolt on edge	233281	
36" bolt on tooth (4 required)	233266	
42" bolt on tooth (5 required)	233266	
48" bolt on tooth (5 required)	233266	
54" bolt on tooth (6 required)	233266	
60" bolt on tooth (7 required)	233266	
68" bolt on tooth kit (8 required)	233266	

MINI ATTACHMENTS

MINI ATTACHMENTS FOR COMPACT TOOL CARRIERS AND MINI SKID-STEER LOADERS

MINI 4-IN-1 MULTI-PURPOSE BUCKET



Carrier Specifications
Lift Capacity
2500 lbs.

- Dual hydraulic cylinders
- High dump, dozer blade, grapple, general purpose bucket
- High carbon steel front cutting edge

MINI 4-IN-1 MULTI-PURPOSE BUCKET Includes mounting brackets (specify) and hoses	ORDER CODE	SHIP WEIGHT (LBS)
Standard Duty Mini Multi-Purpose (4-in-1) Bucket		
42" (5.5 ft ³) CII mount	2008270	250
48" (6.6 ft ³) CII mount	233333	281
Heavy Duty Mini Multi-Purpose (4-in-1) Bucket		
54" (8.8 ft ³) CII mount	233450	313
54" (8.8 ft ³) Bobcat mount	233351	354
60" (12.8 ft ³) SSL mount	111470	450



MINI ROCK BUCKET



Carrier Specifications
Lift Capacity
1500 lbs.

- 1.125" or .75" tine diameter available
- Allows dirt to be sifted removing rocks, bricks, & foreign materials
- Can be used for back dragging & much more
- High strength alloy steel tines

MINI ROCK BUCKET	ORDER CODE	SHIP WEIGHT (LBS)
42" .75" tine CII mount	19695	138
42" 1.13" tine CII mount	19500	184
48" 1.13" tine CII mount	118191	207



MINI ATTACHMENTS FOR COMPACT TOOL CARRIERS AND MINI SKID-STEER LOADERS

MINI DOZER BLADE



- 30° left and right angle
- 6 way blade requires dual remotes or hydraulic kit
- Replaceable wear edge
- 6° left and right tilt



MINI DOZER BLADE	ORDER CODE	SHIP WEIGHT (LBS)
Mini Angle Blades (includes hydraulic kit)		
47" CII mount, poppet couplers	2004358	257
47" CII mount, flat face couplers	2008100	257
47" Bobcat MT 50/52, flat face couplers	102418	190
67" CII mount, poppet couplers	101776	310
67" CII mount, flat face couplers	101777	310
Mini Angle/Tilt Blades (select from one group 1, 2, or 3)		
47" Bobcat MT 50/52	18989	265
47" Universal mount, no hoses	18999	257
67" Universal mount, no hoses	102292	299

OPTIONS CHOOSE FROM ONE GROUP 1, 2, OR 3	ORDER CODE	SHIP WEIGHT (LBS)
Group 1		
dual remote, flat face couplers	19235	30
dual remote, poppet couplers	100598	30
Group 2		
manual hydraulic valve, flat face couplers	19219	40
manual hydraulic valve, poppet couplers	19230	40
Group 3		
hydraulic/electric valve, flat face couplers	19577	50
hydraulic/electric valve, poppet couplers	100539	50

OPTIONS	ORDER CODE	SHIP WEIGHT (LBS)
47" bolt on edge	2005076	
67" bolt on edge	101460	

MINI ATTACHMENTS

MINI ATTACHMENTS FOR COMPACT TOOL CARRIERS AND MINI SKID-STEER LOADERS

MINI GRAPPLES

MINI BRUSH GRAPPLES

NEW PRODUCT



Carrier Specifications
Lift Capacity
2500 lbs.

- 42", 48", or 54" widths available
- Hydraulic grapple with guarded cylinder
- 1,500 to 3,000 operating pressure (psi)
- High strength grade 50 steel throughout

MINI BRUSH GRAPPLE	ORDER CODE	SHIP WEIGHT (LBS)
42" CII mount	235962	256
48" CII mount	235965	275
54" CII mount	235967	283
42" Bobcat mount	235963	299
48" Bobcat mount	235964	318
54" Bobcat mount	235966	326
48" SSL mount	235902	318
54" SSL mount	235904	325



MINI ROOT GRAPPLES

NEW PRODUCT



Carrier Specifications
Lift Capacity
2500 lbs.

- Brush guard cylinder protection
- AR400 bucket tine construction
- High strength steel throughout
- 1,500 to 3,000 operating pressure (psi)

MINI BRUSH GRAPPLE	ORDER CODE	SHIP WEIGHT (LBS)
42" CII mount	124429	268
48" CII mount	235928	276
53" CII mount	124412	282
42" Bobcat mount	124429-0128	217
48" Bobcat mount	235930	225
53" Bobcat mount	235842	227
48" SSL mount	235917	264
54" SSL mount	235845	270



MINI ATTACHMENTS FOR COMPACT TOOL CARRIERS AND MINI SKID-STEER LOADERS

MINI SCRAP GRAPPLES

NEW PRODUCT



Carrier Specifications
Lift Capacity
2500 lbs.

- 36", 42", or 48" widths available
- Hydraulic grapple

MINI SCRAP GRAPPLE	ORDER CODE	SHIP WEIGHT (LBS)
36" CII mount	107147	281
42" CII mount	235913	300
48" CII mount	235907	329
54" CII mount	235870	349
36" Bobcat mount	235877	316
42" Bobcat mount	235916	340
48" Bobcat mount	235894	368
54" Bobcat mount	235883	388
48" SSL mount	235882	366
54" SSL mount	235871	385

OPTIONS	ORDER CODE	SHIP WEIGHT (LBS)
36" bolt on edge	107156	
42" bolt on edge	107157	
48" bolt on edge	107158	
54" bolt on edge	233268	



MINI ATTACHMENTS

MINI ATTACHMENTS FOR COMPACT TOOL CARRIERS AND MINI SKID-STEER LOADERS

LEVELER



- Grades and backfills rough ground
- Carrying platform for brush, trees, blocks, etc.

LEVELER	ORDER CODE	SHIP WEIGHT (LBS)
48" CII mount	2000857	135



MINI POWER SHOVEL



- Pick your own mount
- No hydraulics or electrical required
- Great for removing & transplanting shrubs, bushes, & small trees

MINI POWER SHOVEL	ORDER CODE	SHIP WEIGHT (LBS)
CII mount	2000867	165
Bobcat mount	125437	165



MINI ATTACHMENTS FOR COMPACT TOOL CARRIERS AND MINI SKID-STEER LOADERS

MINI PALLET FORKS



- Spill guard
- 36", 42" & 48" fork tine lengths
- Adjustable width



MINI PALLET FORKS	ORDER CODE	SHIP WEIGHT (LBS)
Standard Duty Pin-Mount Frame		
30" CII mount	233247	162
30" Bobcat mount	233248	183
Standard Duty Pin-Mount Tines - 1500 lbs Rated Operating Capacity		
1.18" x 3.15" x 32" (Pair)	13653	
1.18" x 3.15" x 42" (Pair)	13654	
Heavy Duty ITA Mount Frame		
40" CII mount	123311	210
40" Bobcat mount	233250	223
Heavy Duty ITA Mount Tines - 2500 lbs Rated Operating Capacity		
1.38" x 4" x 42" (Pair)	102028	
1.38" x 4" x 48" (Pair)	102030	

MINI POWER BOX RAKE



- Direct drive motor is embedded within frame and drum providing optimal protection from dirt and debris
- Adjustable barrier crafted from eco-friendly recycled aircraft rubber
- Specially shaped and placed carbide teeth ensure the best possible seedbed
- Easily removable endplates
- Dual independently adjustable gauge wheels
- Multi-position gates



MINI POWER BOX RAKE	ORDER CODE	SHIP WEIGHT (LBS)
D4M - Manual Angle CII mount	22748M-0961	365
D4M - Manual Angle Bobcat mount	22748M-0128	365
D4H - Hydraulic Angle CII mount	22748H-0961	380
D4H - Hydraulic Angle Bobcat mount	22748H-0128	380

MINI ATTACHMENTS

MINI ATTACHMENTS FOR COMPACT TOOL CARRIERS AND MINI SKID-STEER LOADERS

MINI SKID/SWING HOES



- Fixed or swing configurations available
- Bucket curl feature
- 8", 10", & 12" buckets available

MINI SKID/SWING HOE	ORDER CODE	SHIP WEIGHT (LBS)
Fixed Skid Hoe		
universal mount, poppet couplers	89192	166
universal mount, flat face couplers	89349	165
ASV RC30 / Polaris	111131	150
Bobcat MT50/52	18759	155
Swing Skid Hoe		
universal mount, no hoses	100853	250
Bobcat MT50-52, no hose or valve	118234	325
ASV/Polaris, no hose or valve	122233	338
Bucket widths		
8" standard (2 teeth)	88508	40
10" standard (3 teeth)	88510	43
12" standard (3 teeth)	88512	58
Options for Swing Hoe		
hydraulic kit, dual remote, flat face couplers	102488	10
hydraulic kit, dual remote, poppet couplers	102489	10
hydraulic kit, hydraulic valve, flat face couplers	102490	15
hydraulic kit, hydraulic valve, poppet couplers	102491	15
hydraulic kit, hydraulic/electric valve, flat face couplers	102492	20
hydraulic kit, hydraulic/electric valve, poppet couplers	102493	20



MINI SNOW BLADE



- Hydraulically or manually angles 30° in either direction
- Reversible, replaceable wear edge, optional rubber edge
- Adjustable skid shoes
- Spring-loaded trip mechanism
- 7-gauge steel blade

MINI SNOW BLADE - 114 SERIES	ORDER CODE	SHIP WEIGHT (LBS)
48" manual angle snow blade** CII mount	11448M-0961	420
48" hydraulic angle snow blade** CII mount	11448-0961	425
48" hydraulic angle snow blade** ASV/Polaris mount	11448-0002	437
48" hydraulic angle snow blade** Bobcat mount	11448-0128	460

**Denote desired angle type when ordering



MINI ATTACHMENTS FOR COMPACT TOOL CARRIERS AND MINI SKID-STEER LOADERS

MINI SNOW BLADE CONT.

MOUNTING		
Contact Customer Service at (833) 723-1843		
OPTIONS - REPLACEMENT PARTS	ORDER CODE	SHIP WEIGHT (LBS)
Optional Edge Kits		
Rubber edge kit	118937	150
Steel edge kit	118936	50
Angle Kits		
Manual Angle Kit	FFC10014	NA
Hydraulic Angle Kit	FFC10049	NA

MINI SNOW BLOWER



- The new 3D floating hitch offers side to side, up and down, and front to back motion to allow the snow blower to have the smoothest operating experience when working on uneven surfaces
- The 3D floating hitch also allows for an uninterrupted scrape offering a cleaner surface which means less salt is required
- The dual articulating chute offering unprecedented user control on where to place the snow with the 270 degrees of motion and ability to blow snow from as close as 3 feet or up to 45 feet
- The skid skis offer toolless adjustment which enable users to quickly and easily transition from gravel to pavement

Specifications - Mini Snow Blower									
Model #	Weight	Cutting Width	Cutting Height	Overall Length	Min Overall Height	Max Overall Height	Auger Dia.	Flow	Hydraulic Pressure
25048B-0961	820 lbs	48"	27.5"	46"	60"	71"	15"	8-15 GPM	3500 PSI

STANDARD FLOW SNOW BLOWER	ORDER CODE	SHIP WEIGHT (LBS)
48" Standard-Flow Snow Blower CII mount	25048B-0961	820



REPLACEMENT PARTS	ORDER CODE	SHIP WEIGHT (LBS)
Steel Edge Kit	28-11300-48	
Polyurethane Edge Kit	28-11301-48	
Steel Wear Shoe Kit	28-11312	
Soft Wear Shoe Kit	28-11313	
Kit Service Supply/Return Hoses/Ftgs SF/LF	28-11342	
Kit Service QD 1/2" ISO 16028 (1 M & 1 F)	28-9570	
Kit Service Chute Rotation Motor	28-11302	
Kit Service Impeller LF Motor (Motor & Hardware)	28-11305	
Kit Service Auger LF Motor (Motor & Hardware)	28-11308	
Kit Seal Impeller/Auger Motor (Motor & Hardware)	LAF4572-0000	

MINI ATTACHMENTS

MINI ATTACHMENTS FOR COMPACT TOOL CARRIERS AND MINI SKID-STEER LOADERS

MINI STUMP GRINDER



- Ball bearing mounted cutting wheel provides smooth, trouble free operation
- Adjustable wheel cutting angle allows optimal cutting for any type of stump
- Two motor size options



MINI STUMP GRINDER		ORDER CODE	SHIP WEIGHT (LBS)
8 to 11 GPM does not include mount, hoses, or wheel		101865	325
10 to 14 GPM does not include mount, hoses, or wheel		101866	325

MOUNTS - ONE REQUIRED		ORDER CODE	SHIP WEIGHT (LBS)
Universal mounting assembly		101868	67
ASV RC30 mounting assembly		104373	100
Bobcat MT50/52 mounting assembly		104374	100
C&P 027 mounting assembly		104375	113
Gehl mounting assembly		116575	65

HYDRAULIC KIT (ONE REQUIRED)		ORDER CODE	SHIP WEIGHT (LBS)
hose kit, flat face couplers		101874	15
hose kit, poppet couplers		101875	10

TEETH OPTIONS (ONE REQUIRED)		ORDER CODE	SHIP WEIGHT (LBS)
wheel assembly with bolt-on teeth		101876	32
wheel assembly with square teeth		101877	36

REPLACEMENT TEETH		ORDER CODE	SHIP WEIGHT (LBS)
tooth kit, bolt-on teeth		102198	23
tooth kit, square teeth		102199	10

BUNDLED MINI STUMP GRINDERS		ORDER CODE	SHIP WEIGHT (LBS)
includes Universal Mount, Host Kit (flat face couplers), wheel assembly with teeth as specified			
Mini CTC Stump Grinder Bolt-on-teeth (8-11 gpm)		101865-SHK	439
Mini CTC Stump Grinder Square teeth (8-11 gpm)		101865-SQR	443
Mini CTC Stump grinder Bolt-on-teeth (10-14 gpm)		101866-SHK	439
Mini CTC Stump Grinder Square teeth (10-14 gpm)		101866-SQR	443

MINI ATTACHMENTS FOR COMPACT TOOL CARRIERS AND MINI SKID-STEER LOADERS

MINI TILLER



- Replaceable and reversible tines
- Adjustable depth guide
- 8 to 15 GPM recommended
- 1,500 to 3,000 operating pressure (PSI)

MINI TILLER	ORDER CODE	SHIP WEIGHT (LBS)
40" CII mount, flat face couplers	2008000	320
40" CII mount, poppet couplers	2004807	320
48" CII mount, flat face couplers	104569	357



MINI TREE FORK



- 33" length tines
- Up to 27" maximum hydraulic adjustable width
- Hydraulic controlled cylinder

MINI TREE FORK - HYDRAULIC	ORDER CODE	SHIP WEIGHT (LBS)
25" Tree Fork, CII mount, poppet couplers	2000382	145
25" Tree Fork, CII mount, flat face couplers	2008130	145



MINI ATTACHMENTS

MINI ATTACHMENTS FOR COMPACT TOOL CARRIERS AND MINI SKID-STEER LOADERS

MINI TRENCHER



- 2 motor options to match the flow of many skid-steer loaders
- Fixed length booms available featuring spring-loaded, self adjusting idler with full rock guards
- 50,000 lb 1.65" anti-back flex-chain for tooth pattern versatility to support many soil types and conditions

! *Note: 615 Trencher is limited to skid steers with up to 1,000 lb. lift capacity and maximum flow of 16 GPM.*

i **TO ORDER: CHOOSE TRENCHER ASSEMBLY, BOOM & CRUMBER ASSEMBLY, CHAIN & TEETH ASSEMBLY, MOUNT AND HYDRAULIC KIT**

COMPLETE 615 TRENCHER WITH BOOM & CHAIN/TEETH ASSEMBLIES (INCLUDES HOSES)-MUST ORDER COUPLERS	ORDER CODE	SHIP WEIGHT (LBS)
36" digging depth, 6" wide chain, 6-10 gpm, 70/30 tooth every station, fixed MTG	124901	525
36" digging depth, 6" wide chain, 10-16 gpm, tooth every station, fixed MTG	124902	518



TRENCHER ASSEMBLY	ORDER CODE	SHIP WEIGHT (LBS)
615 trencher assembly, 6-10 GPM	18392	274
615 trencher assembly, 10-16 GPM	18393	250

BOOM & CRUMBER ASSEMBLIES	ORDER CODE	SHIP WEIGHT (LBS)
24" digging depth (25 stations)	18401	115
30" digging depth (29 stations)	18402	123
36" digging depth (32 stations)	18403	159
48" digging depth (41 stations)	18404	168

CHAIN & TEETH ASSEMBLIES (MUST MATCH BOOM & CRUMBER SIZE)	ORDER CODE	SHIP WEIGHT (LBS)
38,000# / 1.654 Pitch / Cut-Type Teeth / Tooth Every Station		
for 24" boom 4.5" wide chain	16692	61
for 24" boom 6" wide chain	16691	66
for 24" boom 8" wide chain	16690	76
for 24" boom 10" wide chain	16689	82
for 24" boom 12" wide chain	16688	94
for 30" boom 4.5" wide chain	16687	70
for 30" boom 6" wide chain	16686	76
for 30" boom 8" wide chain	16685	88
for 30" boom 10" wide chain	16684	98
for 36" boom 4.5" wide chain	89822	76
for 36" boom 6" wide chain	89823	84
for 36" boom 8" wide chain	89824	96
for 48" boom 4" wide chain	18772	138
for 48" boom 6" wide chain	18773	154

MINI ATTACHMENTS FOR COMPACT TOOL CARRIERS AND MINI SKID-STEER LOADERS MINI TRENCHER CONT.

CHAIN & TEETH ASSEMBLIES CONT. (MUST MATCH BOOM & CRUMBER SIZE)		ORDER CODE	SHIP WEIGHT (LBS)
38,000# / 1.654 Pitch / 70/30 Combination / Shark-Type / Cup-Type Teeth / Tooth Every Station			
for 24" boom	4.5" wide chain	119509	51
for 24" boom	6" wide chain	18763	65
for 24" boom	8" wide chain	18764	71
for 24" boom	10" wide chain	18765	78
for 24" boom	12" wide chain	18766	89
for 30" boom	6" wide chain	18767	76
for 30" boom	8" wide chain	18768	82
for 30" boom	10" wide chain	18769	90
for 36" boom	4.5" chain	89825	76
for 36" boom	6" wide chain	89826	83
for 36" boom	8" wide chain	89827	92
for 36" boom	10" wide chain	18777	99
for 36" boom	12" wide chain	18778	113
for 48" boom	4.5" wide chain	18770	142
for 48" boom	6" wide chain	18771	153

MOUNTING KITS		ORDER CODE	SHIP WEIGHT (LBS)
mini-loader, universal		89952	46
mini-loader, universal offset		15495	56
John Deere 35D		113988	40
John Deere 50D/50ZTS Coupler		116052	99
Polaris 300/ASV RC30		24305	77

* Includes Hydraulic Kit

HYDRAULIC KITS		ORDER CODE	SHIP WEIGHT (LBS)
Mini Loader			
56" hose, poppet couplers		18559	20
56" hose, flat face couplers		18558	20

REPLACEMENT PARTS		ORDER CODE	SHIP WEIGHT (LBS)
Tooth Left 1.654 - Cup Style		31595	
Tooth Right 1.654 - Cup Style		31596	
Tooth Center 1.654 - Shark Style		31592	
Tooth Left 1.654 - Shark Style		31593	
Tooth Right 1.654 - Shark Style		31594	

MINI ATTACHMENTS

MINI ATTACHMENTS FOR COMPACT TOOL CARRIERS AND MINI SKID-STEER LOADERS

MINI VIBRATORY PLOW



- 12' turning radius
- Rotating coulter wheel frame mounted
- Optional hydraulic steering assembly
- Optional cable chute blades, reel mount, and pulling accessories available



TO ORDER: CHOOSE PLOW ASSEMBLY, HYDRAULIC KIT, MOUNT AND BLADE



MINI VIBRATORY PLOW ASSEMBLY	ORDER CODE	SHIP WEIGHT (LBS)
VP10 Mini Vib Plow 8 to 11 GPM	19733	467
VP10 Mini Vib Plow 10 to 14 GPM	19734	467

MINI VIBRATORY PLOW HYDRAULIC KIT (ONE REQUIRED)	ORDER CODE	SHIP WEIGHT (LBS)
without steering, .50" poppet couplers	19380	10
without steering, .50" flat face couplers	19381	10
with steering, .50" poppet couplers *	19382	25
with steering, .50" flat face couplers*	19383	25

*Skid-Steer must have two sets of auxiliary hydraulics

MINI VIBRATORY PLOW MOUNTING KITS (ONE REQUIRED)	ORDER CODE	SHIP WEIGHT (LBS)
universal mounting	19384	45
3-point category I mounting kit	101827	45
ASV/Polaris mounting kit	19389	45
Bobcat MT50/MT100 mounting	102012	86

MINI VIBRATORY PLOW BLADES (ONE REQUIRED)	ORDER CODE	SHIP WEIGHT (LBS)
.375" (3/8") Wide Blade		
.375" blade 20°, 1" clevis, 6" to 12" depth	19325	25
.375" blade 30°, 1" clevis, 6" to 12" depth	19441	20
.375" blade 20°, 1" clevis, 12" to 18" depth	18690	25
.375" blade 30°, 1" clevis, 12" to 18" depth	2007030	25
.50" (1/2") Wide Chute Blade		
.50" chute blade 20°, 6" to 12" depth	19442	40
.50" chute blade 30°, 6" to 12" depth	19443	40
.50" chute blade 20°, 12" to 18" depth	19444	45
.50" chute blade 30°, 12" to 18" depth	19445	45
.50" chute blade 20°, 20" to 24" depth	109214	31
.50" chute blade 30°, 18" to 24" depth	112256	53

MINI VIBRATORY PLOW CONTINUED NEXT PAGE

MINI ATTACHMENTS FOR COMPACT TOOL CARRIERS AND MINI SKID-STEER LOADERS

MINI VIBRATORY PLOW CONT.

OPTIONS	ORDER CODE	SHIP WEIGHT (LBS)
pull bullet assembly, 2.5" dia	17754	5
cable pull grip, 1" to 1.24" cable	2001171	3
cable pull grip, .75" to .99" dia.	100435	3
cable pull grip, 1.25" to 1.49" dia.	100436	3
pipe bullet assembly, 1" to 1.5" pipe	18740	5
cable reel mount, 24" max. dia. reel	19085	26
steering conversion kit, .50" poppet couplers	19732	20
steering conversion kit, .50" flat face couplers	19735	20

MINI VIBRATORY ROLLER



- 36" smooth drum

Specifications											
Model #	Overall Width	Drum Width	Overall Height	Overall Length	Drum Diameter	Operating Weight (lbs)	Dynamic Force (lbs)	Vibrating Speed (vpm)	Vibrating Weight (lbs)	Drum Oscillation/Tile	Hydraulic Motor Flow (gpm)
109100	41.47"	36"	21.5"	34.4"	20"	840	2488	2000	507	15°	6-9
109101	41.47"	36"	21.5"	34.4"	20"	840	2488	2000	507	15°	10-14

	ORDER CODE	SHIP WEIGHT (LBS)
Smooth Drum		
36" smooth drum (6 to 9 gpm) CII mount	109100	840
36" smooth drum (10 to 14 gpm) CII mount	109101	840



MINI ATTACHMENTS

MINI ATTACHMENTS FOR COMPACT TOOL CARRIERS AND MINI SKID-STEER LOADERS

MINI SKID/SWING HOES



- Fixed or swing configurations available
- Bucket curl feature
- 8", 10", & 12" buckets available



MINI SKID/SWING HOE	ORDER CODE	SHIP WEIGHT (LBS)
Fixed Skid Hoe		
universal mount, poppet couplers	89192	166
universal mount, flat face couplers	89349	165
ASV RC30 / Polaris	111131	150
Bobcat MT50/52	18759	155
Swing Skid Hoe		
universal mount, no hoses	100853	250
Bobcat MT50-52, no hose or valve	118234	325
ASV/Polaris, no hose or valve	122233	338
Bucket widths		
8" standard (2 teeth)	88508	40
10" standard (3 teeth)	88510	43
12" standard (3 teeth)	88512	58
Options for Swing Hoe		
hydraulic kit, dual remote, flat face couplers	102488	10
hydraulic kit, dual remote, poppet couplers	102489	10
hydraulic kit, hydraulic valve, flat face couplers	102490	15
hydraulic kit, hydraulic valve, poppet couplers	102491	15
hydraulic kit, hydraulic/electric valve, flat face couplers	102492	20
hydraulic kit, hydraulic/electric valve, poppet couplers	102493	20

MULCHERS



MULCHERS

MULCHERS, SERIES II



- 36", 42" and 72" cutting widths available
 - 36" and 42" excavators only
 - 60" Skid-steer only and excavator only
 - 72" Skid-steer only
- Shreds up to 12" diameter hardwood trees
- Tree stabilization guide improves handling of tall trees and slender saplings (MM36, MM421, MM422 models only; patent protected by US8316901)
- Reversible carbide teeth and claw teeth can easily be interchanged without the need of rebalancing the rotor
- Synchronous belt drive system eliminates belt and belt drive sprocket slippage
- Heavy duty bent axis variable displacement piston motor



Specifications

Model	Prime Mover	Metric Ton	Weight*	Overall Width	Overall Height	Overall Length	Cutting Width	Operating Pressure	Hydraulic Flow (GPM)	Rec. Hydraulic HP	Number of Teeth
MM36E	Excavator	08-16	1580 lbs	48.5"	24.75"	33.03"	36"	3500-5000	28-41	40-65	26
MM36E	Excavator	08-16	1600 lbs	48.5"	24.75"	33.03"	36"	3500-5000	42-60	65-90	26
MM421E	Excavator	14-21	2505 lbs	58"	31.3"	34.3"	42"	4500-5800	29-39	55-95	30
MM422E	Excavator	20-30	2920 lbs	58.6"	33"	34.9"	42"	4500-5800	40-52	75-115	30
MM60S	Skid Steer	-	2530 lbs	73"	60.42"	49.5"	60"	3000-4000	30-45	60-95	44
MM60E	Excavator	-	2710 lbs	73"	-	-	60"	3000-5800	30-60	60-95	44
MM60C	Comb.**	-	2980 lbs	73"	68.87"	53.33"	60"	3000-5800	30-60	60-95	44
MM60H	Forestry	-	2550 lbs	73"	60.42"	49.5"	60"	4500-5800	35-45	90-130	44
MM601E	Excavator	16-25	2945 lbs	75.5"	31.3"	34.3"	60"	4500-5800	32-44	60-100	44
MM72S	Skid-Steer	-	2860 lbs	85"	60.42"	49.5"	72"	3500-5000	30-45	75-95	54
MM72H	Forestry	-	2880 lbs	85"	60.42"	49.5"	72"	4500-5800	30-45	90-130	54

* Does not include weight of excavator mount for excavator models

** Comb.: Excavator and Skid Steer



Note: We highly recommend the purchase of guarding to protect operator and machine from flying debris in harsh forestry and land clearing environments. Please refer to the SSL Forestry Guarding section on page 190 for more information. For Skid-Steer loaders only.



MULCHERS FOR SKID-STEER LOADERS



TO ORDER: Choose Mulcher Assembly, Hose Kit, and Tooth Set. Universal SSL Mount included unless otherwise specified.

MULCHER ASSEMBLY	ORDER CODE	SHIP WEIGHT (LBS)
60" cutting width (3 line)		
MM60S Series II Mulcher	115622	2605
MM60C Series II Mulcher (requires combination mount from Excavator Mounts section)	115625	3005
MM60S Series II Mulcher Complete (Claw Teeth Included)	124171	2700
MM60S Series II Mulcher Complete (Reversible Claw Hammers Included)	125346	2700
60" cutting width (5 line)		
MM60S Series II Mulcher	115623	2605
MM60H Series II Mulcher	115626	2625

MULCHERS CONTINUED NEXT PAGE



MULCHERS, SERIES II CONT. MULCHERS FOR SKID-STEER LOADERS CONT.

MULCHER ASSEMBLY CONT.	ORDER CODE	SHIP WEIGHT (LBS)
72" cutting width (3 line)		
MM72S Series II Mulcher	115630	2975
MM72S Series II Mulcher Complete (Claw Teeth Included)	124652	3070
MM72S Series II Mulcher Complete (Reversible Claw Hammers Included)	126008	3070
72" cutting width (5 line)		
MM72S Series II Mulcher	115631	2975
MM72H Series II Mulcher	115632	2975
HOSE KITS & COUPLERS	ORDER CODE	SHIP WEIGHT (LBS)
Hose Kits (3 line)		
65" hose kit, 4000 max psi	110914	1
80" hose kit, 4000 max psi	110915	1
96" hose kit, 4000 max psi	110916	1
Hose Kits (5 line)		
65" hose kit, 4000 max psi	114047	16
80" hose kit, 4000 max psi	114048	19
96" hose kit, 4000 max psi	114049	23
65" hose kit, 6000 max psi	116995	27
80" hose kit, 6000 max psi	116996	31
96" hose kit, 6000 max psi	116997	35
Coupler Cross Reference *		
select from individual couplers listed below (note: case drain coupler required)		
Case Drain / Auxiliary Door Function #8 Boss O-Ring		
.25" body male flat face coupler with adapter	111215	1
.25" body female flat face	115232	1
.38" body male	84923	1
.38" body female	84928	1
.50" body female	14175	2
.50" body male	14176	2
Flat Face Quick Disconnect Coupler With No. 12 Boss O-Ring Main Power/Return		
.50 body male	22519	2
.50 body female	22518	2
.625 body male	84922	3
.625 body female	84921	3
.75 body male	22521	3
.75 body female	22520	3
TOOTH SETS	ORDER CODE	SHIP WEIGHT (LBS)
for 60" Mulcher		
reversible carbide hammers (44 pieces)	116091	170
reversible claw teeth (44 pieces)	116092	170
for 72" Mulcher		
reversible carbide hammers (54 pieces)	111794	200
reversible claw teeth (54 pieces)	112578	200

TOOTH SETS CONTINUED NEXT PAGE



Reversible Carbide Tooth



Reversible Claw Tooth

MULCHERS

MULCHERS, SERIES II CONT.

MULCHERS FOR SKID-STEER LOADERS CONT.



MULCHERS

TOOTH SETS CONT.	ORDER CODE	SHIP WEIGHT (LBS)
Replacement Tooth Sets		
reversible carbide hammer (includes 1 hammer)	600-168	4
reversible claw tooth	111588	4
Bolts		
bolt M16X 110	700-111	1
bolt M16X 75	700-114	1
lock washer special	10165	1

REPLACEMENT PARTS	ORDER CODE	SHIP WEIGHT (LBS)
Belt, Synchronous, Gates Poly Chain GT	113762	
Skid Shoe - Right Weldment	115777	
Skid Shoe - Left Weldment	115778	

OPTIONS	ORDER CODE	SHIP WEIGHT (LBS)
Deflector Door Assembly		
For MM60E Series II only	116550	105
Case Drain Relief Valve		
For MM36 Series II only	116930	5
For MM60 Series II only	116931	7
For MM72 Series II only	116932	7
Oil Coolers for Series II Mulchers only		
For MM60 Series II Factory Installed	115851	110
For MM60 Series II Dealer Installed	115852	140
For MM72 Series II Factory Installed	115853	115
For MM72 Series II Dealer Installed	115854	145
Oil Coolers (600 PSI Rated) For Non Series II Mulchers only		
For 60" Mulcher Factory Installed	112960	80
For 60" Mulcher Dealer Installed	114018	80
Convert from 5 line to 3 line coupler system	107651	15
Must choose electrical control box OR adapter harness for in-cab controls to operate door		
Electrical Control Box		
Control box w/ power lead	28-10754	5
Adapter Harness for In-Cab Control		
Wire Harness (multi function in cab controls) for CNH, JCB, Bobcat, Mustang, Kubota, Takeuchi, Volvo 14 Pin-8 Pin	LAF9360-0000	5
Wire Harness Adapter John Deere EH OEM SSL	07-7626	5
Harness Adapter F/CAT XPS D 14 Pin-8 Pin	119740	5
Harness Adapter F/CAT XHP D 14 Pin-8 Pin	119741	5
Wire Harness Adapter CAT B&C Series SSL Hi Flow	07-10170	5
Wire Harness Adapter Komatsu SSL	07-10057	3
Wire Harness Adapter F/JD SSL	LAF9361	5
7-pin for Bobcat	07-9548	5



MULCHERS, SERIES II CONT. MULCHERS FOR SKID-STEER LOADERS CONT.

SSL GUARDING PACKAGES



Note: We highly recommend the purchase of guarding to protect operator and machine from flying debris in harsh forestry and land clearing environments. For Skid-Steer loaders only.

KUBOTA GUARDING PACKAGE

	ORDER CODE	SHIP WEIGHT (LBS)
Model SVL95-2		
Complete Package: Top Guard, Working Light, Rear Grille Guard and Hyd Connection	WF8CFSVL2001	
Top Guard Kit, KU SVL Series	WF8290000	
Working Light Kit (FR/RR)	WF8290020	
Rear Grille Guard. KU SVL95-2	WF8290010	
Hydraulic Connection Guard Kit	WF8290030	
SSL SVL95-2s		
Def Cover, Kit, KU, SVL95-2S	WF8190000	
Kubota Excavator Cab Guarding		
Front Window Guard - Wire, KA KXX080-4, Enclosed Cab	WF1290060	

MULCHERS

MULCHERS, SERIES II CONT. FORESTRY GUARDING PACKAGES CONT.



HYDRAULIC CONNECTION GUARDS

Heavy-duty formed 3/16" steel plate. Easy bolt-on installation – no welding. Complete Connect Under Pressure (CUP) manifold protection. Hinged guards for CUP manifold access.



REAR BUMPER

Heavy-duty formed steel plate construction. Bolt-on design requires no welding. Does not interfere with OEM tie-down hook access or compartment doors. Departure angle of 21°



REAR GRILL GUARD

Attaches to heavy duty rear bumper. Upper mounts weld to frame. Heavy-duty design protects radiator from debris while allowing ample airflow. Swings open to allow unhindered access to engine compartment.



SWEEP

Protects rear of machine from falling debris. Tool-less opening from the inside and out and hinges up for emergency egress.



TOP GUARD WITH LIGHT GUARDS

Supported by cab frame and held in place using existing rivnuts. Maintains top window visibility. Low profile design to avoid tree limbs. Includes light guards.



INTAKE SCREENS

Filters debris from entering air cooler area. Helps prevent overheating issues and prolongs life of coolers. Bolt-on (hole modification required), no welding required. Replaceable steel mesh screen design.



SIDE SCREENS

Heavy duty design to protect cab glass. Replaces OEM side screens for use in harsh environments.

CASE FORESTRY GUARDING PACKAGES

	ORDER CODE	SHIP WEIGHT (LBS)
CaseSV300, SV340 & TV380 Tier 4B		
Hydraulic connection guards, FG	W28190000	
Assembly, rear bumper, SSL, FG	W28190010	
Rear grill guard, CS SSL/CTL T4F, FG	W28190060	
Sweep kit, CS CTL/SSL, 90HP T4F, FG	W28190070	
Top guard w/ light guards, FG	W28190040	
Additional intake screens, SV300, FG	W28190050	
Side screen kit, CS SSL/CTL T4F, FG	W28290000	

MULCHERS, SERIES II CONT. MULCHERS FOR EXCAVATORS



TO ORDER: CHOOSE MULCHER ASSEMBLY, EXCAVATOR MOUNT, AND TOOTH SET.

MULCHER ASSEMBLY	ORDER CODE	SHIP WEIGHT (LBS)
36" cutting width		
MM36E Series II Mulcher 28-41 gpm	115620	1620
MM36E Series II Mulcher 42-60 gpm	115621	1620
42" cutting width		
MM421E Series II Mulcher 29-39 gpm	31442-0000	2605
MM422E Series II Mulcher 40-52 gpm	30742-0000	2920
60" cutting width		
MM601 Series II Mulcher 32-44 gpm	31260-0000	3045
MM60E Series II Mulcher	115624	2785
MM60C Series II Mulcher (combination mount required from Mounts)	115625	3005

TOOTH SETS	ORDER CODE	SHIP WEIGHT (LBS)
for 36" Mulcher		
reversible carbide hammers (26 pieces)	116088	110
reversible claw teeth (26 pieces)	116089	110
For 42" Mulcher		
Reversible carbide hammers (30 pieces)	120051	127
Reversible claw teeth (30 pieces)	120052	127
for 60" Mulcher		
reversible carbide hammers (44 pieces)	116091	170
reversible claw teeth (44 pieces)	116092	170
Replacement Tooth Sets		
reversible carbide hammer (includes 1 hammer)	600-168	4
reversible claw tooth	111588	4
Bolts		
bolt M16X 110	700-111	1
bolt M16X 75	700-114	1
lock washer special	10165	1

REPLACEMENT PARTS	ORDER CODE	SHIP WEIGHT (LBS)
for 36" Mulcher		
Belt, Synchronous, Gates Poly Chain GT	113762	
Skid Shoe - Right Weldment	115649	
Skid Shoe - Left Weldment	115650	



Reversible Carbide Tooth



Reversible Claw Tooth

REPLACEMENT PARTS CONTINUED NEXT PAGE

MULCHERS

MULCHERS, SERIES II CONT.

MULCHERS FOR EXCAVATORS CONT.



REPLACEMENT PARTS	ORDER CODE	SHIP WEIGHT (LBS)
For 42" Mulcher		
Belt, Synchronous, Gates Poly Chain GT - MM421	113762	
Belt, Synchronous, Gates Poly Chain GT - MM422	119595	
Right Skid Shoe WMT - MM421 & MM601	119547	
Left Skid Shoe WMT - MM421 & MM601	119548	
Left Skid Shoe WMT - MM422	119529	
Right Skid Shoe WMT - MM422	119530	
for 60" Mulcher		
Belt, Synchronous, Gates Poly Chain GT	113762	
Right Skid Shoe WMT - MM421 & MM601	119547	
Left Skid Shoe WMT - MM421 & MM601	119548	
Skid Shoe - Right Weldment	115777	
Skid Shoe - Left Weldment	115778	

EXCAVATOR MOUNTS	ORDER CODE	SHIP WEIGHT (LBS)
MM36E Series II Excavator Mounts - Contact Factory for Mounts Not Listed		
Takechi TB175/180FR	113362	140
Takechi TB1140	113997	180
Kubota KX080 Quick Attach	113468	130
Kobelco SK 150CC Mark-IV / SK 160-Mark IV	114483	200
Kobelco SK 60 Mark IV / SK 70SR	115324	140
Bobcat 442	114107	160
CAT 307 /308	114588	130
CAT 311 /312CL /313 /314	114784	185
JCB JS130	114290	180
JCB JS 160	114304	240
JCB JS 70 / JZ 70	114521	145
JCB 214E / 214S / 215E / 215S	115573	180
John Deere 200C LC/225C LC	114129	240
John Deere 110D / 120D / 130 LC / 135 C RTS	113997	180
John Deere 160CLC / 590D / 590E / 595D	116019	240
Komatsu PC200-3,5,6 / PC210 / PC228USLC	115228	285
Case CX80	114521	145
Case CX130/CX135 / 19010 / 9010B	114290	180
Case CX160	114304	240
Case CX160 with thumb	118932	264
Case CX75 SR / CX80 / 9007 / 9007B	114521	145
Case 9030B	114330	295
Cat 318CL / 318CLN / 320 B-Link	116663	245
Hitachi EX 150	116019	240
Hitachi EX 150	116019	240

EXCAVATOR MOUNTS CONTINUED NEXT PAGE

MULCHERS, SERIES II CONT. MULCHERS FOR EXCAVATORS CONT.

EXCAVATOR MOUNTS CONT.	ORDER CODE	SHIP WEIGHT (LBS)
MM36E Series II Excavator Mounts - Contact Factory for Mounts Not Listed		
Hitachi EX200 / EX225	114129	240
Hitachi EX110 / EX110-5 / EX100-2,3,5 / EX120-2,3,5 / EX130 / ZX120	113997	180
John Deere 290D	117856	144
John Deere 200C LC / 225C LC / 200 DL, with thumb	118357	282
Kobelco SK 130-IV / SK135SR	115517	180
Kobelco SK 135 SR	115593	215
Komatsu PC 88MR-8	115091	135
Komatsu PC120-6 / PC128US-2 / PC138USLC-2 / PC158 / PC158US-2,6	115405	180
Komatsu PC150 / PC160LC-7 / PC180	115871	200
Link-Belt 2700Q / 160LX	114304	240
Link-Belt 135MSR / 130LX / 3650Q	114290	180
Link-Belt 75MSR / LS1600 CII / 1600Q / 80 MSR	114521	145
Volvo EC140 / ECR145C	117120	195
Volvo EC 150 with S6 Quick Attach	114567	190
Volvo EC 160 with S6 Quick Attach	118294	197
Yanmar VI075 / SV100 / Komatsu 88m	115091	135
Case CX145D W/TMB	124983	200
Cat M313	239068	198
Doosan DX140LC-5	121293	189
Doosan DX80Z	119889	126
Extreme Forest Machine	113409	240
Hyundai HW 140,(SEE NOTES)	125098	207
John Deere 75D-85D-G, PIN GRAB	120508	132
Takeuchi TB290 / TB370	122933	145
Volvo EC140/150 W/STEELWRIST S6 COUPLER	233086	182
Volvo EC160 S1	120565	424
Volvo EC88/ECR88	120304	151
Volvo EW180D,ROCKLAND PIN GRABBER	121344	200
Case CX210/220,MM36	121560	263
MM60E Series II Excavator Mounts - Contact Factory for Mounts Not Listed		
Case 9010B / CX130 / CX135	116006	220
Case 90301 / 9030B / CX210 / CX225	114330	295
Cat 322 (S-Link)	110405	300
Cat 311 / 312 / 313 /314	110597	250
Cat 315D	116986	231
Cat 320 CL	118472	355
Cat 325 / (C-Link) / 320 / 321 / CRL 330	111607	300
CWS HE250 with Quick Attach	117798	350
Doosan DX225	117662	295
Hill Eng Coupler R210 AL3	119338	335
Hitachi EX200 / EX225USR / ZX200 / ZX225	114778	295
Hyundai 200W-7 / R21066-7	111498	300

EXCAVATOR MOUNTS CONTINUED NEXT PAGE

MULCHERS

MULCHERS FOR EXCAVATORS CONT.

EXCAVATOR MOUNTS CONT.	ORDER CODE	SHIP WEIGHT (LBS)
MM60E Series II Excavator Mounts - Contact Factory for Mounts Not Listed		
JCB JS200 / JS220	114330	295
John Deere 200CLC /225 C RTS	114778	295
Kobelco SK 220 / LC Mark IV / SK 250LC	112526	320
Kobelco SK 150 / 160-IV	112613	252
Kobelco Sk 200LC IV / Sk 210 / SK 235SR	115319	280
Tigercaat 822	118897	395
Volvo S1 Coupler	118690	542
Volvo ECR235C	117675	295
Case CX210C/235C	123112	323
Cat 315D W/THUMB	124993	272
Doosan DX140LC-5	125000	225
John Deere 130G	120007	194
John Deere 270DLC	112755	335
Komatsu PC 138 USLC-8	112028	230
Sany SY235 W/THUMB	123585	373
Takeuchi TB2150	124987	220
Volvo ECR140 / ECR145	120227	200
Volvo EW180D PIN ON	123822	230
MM421 Series II Excavator Mounts - Contact Factory for Mounts Not Listed		
Case CX 135 MSR, P-P 385mm	121794-9010	259
Case CX 135C SR, P-P 355mm	121794-9011	255
Case CX 145C SR, P-P 385mm	121794-9010	259
Case CX 160/CX 160B/CX 160C/CX 160D, P-P 435mm	121794-9020	324
Case CX 210/CX 210B/CX 210C/CX 210D, P-P 450mm	121794-9030	327
Caterpillar 314C/314D/314E, P-P 407mm	121794-0311	262
Caterpillar 315B/315C/315D/315F, P-P 463mm	121794-0315	283
Caterpillar M315D, P-P 463mm	121794-0315	283
Caterpillar 316E/316F, P-P 463mm	121794-0315	283
Caterpillar M316D/M316F, P-P 463mm	121794-0315	283
Caterpillar 318B/318C, P-P 445mm	121794-0320	327
Caterpillar 318B/318C, P-P 485mm	121794-0322	332
Caterpillar 318E/318FC, P-P 463mm	121794-0315	283
Caterpillar M318C/M318D, P-P 445mm	121794-0320	327
Caterpillar M318C/M318D, P-P 485mm	121794-0322	332
Caterpillar M318F, P-P 463mm	121794-0315	283
Caterpillar 319D, P-P 445mm	121794-0320	327
Caterpillar 319D, P-P 485mm	121794-0322	332
Caterpillar 320/320B/320C/320D/320E/320F, P-P 445mm	121794-0320	327
Caterpillar 320/320B/320C/320D/320E/320F, P-P 485mm	121794-0322	332
Caterpillar M320F, P-P 445mm	121794-0320	327
Caterpillar M320F, P-P 485mm	121794-0322	332

EXCAVATOR MOUNTS CONTINUED NEXT PAGE

MULCHERS FOR EXCAVATORS CONT.

EXCAVATOR MOUNTS CONT.	ORDER CODE	SHIP WEIGHT (LBS)
MM421 Series II Excavator Mounts - Contact Factory for Mounts Not Listed		
Doosan DX 140LC-3/DX 140LCR-3/DX 140LC-5/DX 140LCR-5, P-P 408mm	121794-3140	263
Doosan DX 140W-5, P-P 408mm	121794-3140	263
Doosan DX 180LC/DX 180LC-3/DX 180LC-5, P-P 464mm	121794-4220	338
Doosan DX 190W-3/DX 190W-5, P-P 464mm	121794-4220	338
Doosan DX 210W/DX 210W-5, P-P 464mm	121794-4220	338
Hitachi ZX 135US/ZX 135US-3/ZX 135US-5, P-P 362mm	121794-7120	256
Hitachi EX 160LC-5, P-P 391mm	121794-7150	316
Hitachi ZX 160LC/ZX 160LC-3/ZX 160LC-5, P-P 391mm	121794-7150	316
Hitachi ZX 180LC-5, P-P 472mm	121794-7201	331
Hitachi ZX 180W, P-P 472mm	121794-7201	331
Hitachi ZX 190W-3, P-P 472mm	121794-7201	331
Hitachi EX 200LC/EX 200LC-2/EX 200LC-3/EX 200LC-5, P-P 472mm	121794-7201	331
Hitachi ZX 200LC/ZX 200LC-3, P-P 472mm	121794-7201	331
Hitachi ZX 210LC-5, P-P 472mm	121794-7201	331
Hitachi ZX 210W, P-P 472mm	121794-7201	331
Hyundai HW 140, P-P 390mm	121794-1130	260
Hyundai HX 140L, P-P 390mm	121794-1130	260
Hyundai R 140LC-7/R 140LC-7A/R 140LC-9/R 140LC-9A, P-P 390mm	121794-1130	260
Hyundai R 140W-7/R 140W-7A/R 140W-9/R 140W-9A, P-P 390mm	121794-1130	260
Hyundai HX 145LCR, P-P 390mm	121794-1130	260
Hyundai R 145LCR-9/R 145LCR-9A, P-P 390mm	121794-1130	260
Hyundai HX 160L, P-P 410mm	121794-2180	275
Hyundai R 160LC-7/R 160LC-7A/R 160LC-9/R 160LC-9A, P-P 410mm	121794-2180	275
Hyundai R 170W-7/R 170W-7A/R 170W-9, P-P 410mm	121794-2180	275
Hyundai HW 180, P-P 410mm	121794-2180	275
Hyundai HX 180L, P-P 410mm	121794-2180	275
Hyundai R 180LC-7/R 180LC-7A/R 180LC-9/R 180LC-9A, P-P 410mm	121794-2180	275
Hyundai R 200W-7/R 200W-7A, P-P 460mm	121794-4201	337
Hyundai HW 210, P-P 460mm	121794-4201	337
Hyundai R 210LC-7/R 210LC-7A/R 210LC-9, P-P 460mm	121794-4201	337
Hyundai R 210W-9/R 210W-9A, P-P 460mm	121794-4201	337
JCB JZ 140, P-P 385mm	121794-9010	259
JCB JS 145, P-P 385mm	121794-9010	259
JCB JS 145W, P-P 385mm	121794-9010	259
JCB JS 160, P-P 435mm	121794-9020	324
JCB JS 160W, P-P 435mm	121794-9020	324
JCB JS 175W, P-P 435mm	121794-9020	324
JCB JS 180, P-P 435mm	121794-9020	324
JCB JS 190, P-P 435mm	121794-9020	324
JCB JS 200, P-P 450mm	121794-9030	327
JCB JS 210, P-P 450mm	121794-9030	327

EXCAVATOR MOUNTS CONTINUED NEXT PAGE

MULCHERS

MULCHERS FOR EXCAVATORS CONT.

EXCAVATOR MOUNTS CONT.	ORDER CODE	SHIP WEIGHT (LBS)
MM421 Series II Excavator Mounts - Contact Factory for Mounts Not Listed		
John Deere 135C/135D/135G, P-P 362mm	121794-7120	256
John Deere 160 LC/160C LC/160D LC/160G LC, P-P 391mm	121794-7150	316
John Deere 180G LC, P-P 472mm	121794-7201	331
John Deere 180C W, P-P 472mm	121794-7201	331
John Deere 190D W/190G W, P-P 472mm	121794-7201	331
John Deere 200 LC/200C LC/200D LC, P-P 472mm	121794-7201	331
John Deere 210C W, P-P 472mm	121794-7201	331
Kobelco SK 135SR, P-P 420mm	121794-2131	265
Kobelco SK 140SRLC/SK 140SRLC-3/SK 140SRLC-5, P-P 420mm	121794-2131	265
Kobelco ED 150, P-P 420mm	121794-2131	265
Kobelco SK 150LC MARK III, P-P 400mm	121794-2150	273
Kobelco SK 150LC MARK IV, P-P 411mm	121794-2151	275
Kobelco ED 160-3/ED 160-5, P-P 420mm	121794-2131	265
Kobelco SK 160LC-6, P-P 411mm	121794-2151	275
Kobelco SK 170LC-8/SK 170LC-9/SK 170LC-10, P-P 411mm	121794-2151	275
Kobelco ED 190-6, P-P 411mm	121794-2151	275
Kobelco ED 195-8, P-P 411mm	121794-2151	275
Kobelco SK 200LC-MARK III/SK 200-3, P-P 430mm	121794-2200	323
Kobelco SK 200LC MARK IV, P-P 442mm	121794-2201	325
Kobelco SK 200SRLC, P-P 442mm	121794-2201	325
Kobelco SK 210LC-6/SK 210LC-8/SK 210LC-9/SK 210LC-10, P-P 442mm	121794-2201	325
Komatsu PC 138USLC-2/PC 138USLC-8/PC 138USLC-10, P-P 374.9mm	121794-0158	250
Komatsu PC 150LC-5/PC 150LC-6, P-P 400.8mm	121794-0150	274
Komatsu PC 158USLC-2/PC 158USLC-6, P-P 374.9mm	121794-0158	250
Komatsu PC 160LC-7/PC 160LC-8, P-P 400.8mm	121794-0150	274
Komatsu PC 170LC-10, P-P 400.8mm	121794-0150	274
Komatsu PW 170ES-6, P-P 400.8mm	121794-0150	274
Komatsu PC 180LC-7, P-P 400.8mm	121794-0150	274
Komatsu PC 200LC-5/PC 200LC-6/PC 200LC-7/PC 200LC-8, P-P 458.1mm	121794-0200	329
Link-Belt 135 SPIN ACE, P-P 385mm	121794-9010	259
Link-Belt 145 X3 SPIN ACE, P-P 385mm	121794-9010	259
Link-Belt 160 LX/160 X2/160 X3/160 X4, P-P 435mm	121794-9020	324
Link-Belt 210 LX/210 X2/210 X3/210 X4, P-P 440mm	121794-2802	324
Takeuchi TB 1140-S2, P-P 362mm	121794-7120	362
Volvo EC 140B/EC 140C/EC 140D, P-P 380mm	121794-5130	259
Volvo ECR 145C/ECR 145D/ECR 145E, P-P 380mm	121794-5130	259
Volvo EC 150, P-P 423mm	121794-5150	277
Volvo EC 160B/EC 160C, P-P 440mm	121794-5160	280
Volvo EC 160D, P-P 423mm	121794-5150	277
Volvo EW 160C/EW 160D, P-P 440mm	121794-5160	280
Volvo EW 170, P-P 423mm	121794-2170	278

EXCAVATOR MOUNTS CONTINUED NEXT PAGE

MULCHERS FOR EXCAVATORS CONT.

EXCAVATOR MOUNTS CONT.	ORDER CODE	SHIP WEIGHT (LBS)
MM421 Series II Excavator Mounts - Contact Factory for Mounts Not Listed		
Volvo EC 180C, P-P 440mm	121794-5160	280
Volvo EC 180D, P-P 423mm	121794-5150	277
Volvo EW 180/EW 180C/EW 180D, P-P 423mm	121794-2170	278
Volvo EC 210/EC 210B/EC 210C, P-P 467mm	121794-4210	331
Volvo EW 210C/EW 210D, P-P 423mm	121794-2170	278
Volvo S1 Mounting	121794-2141	382
Volvo S6 Mounting, P-P 480mm	121794-2140	243
CWS HE120 WBM Manual Wedge Coupler, P-P 355mm	121794-2154	245
MM422 Series II Excavator Mounts - Contact Factory for Mounts Not Listed		
Case CX 210/CX 210B/CX 210C/CX 210D, P-P 450mm	121795-9030	320
Case CX 225 MSR, P-P 450mm	121795-9030	320
Case CX 235C SR, P-P 450mm	121795-9030	320
Case CX 240/CX 240B, P-P 490mm	121795-9040	354
Case CX 250C/CX 250D, P-P 490mm	121795-9040	354
Case CX 290/CX 290B, P-P 490mm	121795-9040	354
Case CX 300D, P-P 490mm	121795-9040	354
Caterpillar 320/320B/320C/320D/320E/320F, P-P 445mm	121795-0320	319
Caterpillar 320/320B/320C/320D/320E/320F, P-P 485mm	121795-0322	325
Caterpillar M320F, P-P 445mm	121795-0320	319
Caterpillar M320F, P-P 485mm	121795-0322	325
Caterpillar 321C/321D, P-P 445mm	121795-0320	319
Caterpillar 321C/321D, P-P 485mm	121795-0322	325
Caterpillar 322/322B/322C, P-P 485mm	121795-0322	325
Caterpillar 322/322B/322C, P-P 512mm	121795-2322	328
Caterpillar M322C/M322D, P-P 445mm	121795-0320	319
Caterpillar M322C/M322D, P-P 485mm	121795-0322	325
Caterpillar 323D/323E/323F, P-P 445mm	121795-0320	319
Caterpillar 323D/323E/323F, P-P 485mm	121795-0322	325
Caterpillar 324D/324E, P-P 485mm	121795-0324	355
Caterpillar 324D/324E, P-P 512mm	121795-1324	358
Caterpillar 325/325B/325C, P-P 485mm	121795-0325	333
Caterpillar 325/325B/325C, P-P 512mm	121795-2325	337
Caterpillar 325D/325F, P-P 485mm	121795-0324	355
Caterpillar 325D/325F, P-P 512mm	121795-1324	358
Caterpillar 326F, P-P 485mm	121795-0324	355
Caterpillar 326F, P-P 512mm	121795-1324	358
Caterpillar 329D/329E/329F, P-P 485mm	121795-0324	355
Caterpillar 329D/329E/329F, P-P 512mm	121795-1324	358
Doosan DX 210W/DX 210W-5, P-P 464mm	121795-4220	330
Doosan DX 225LC/DX 225LC-3/DX 225LC-5, P-P 464mm	121795-4220	330
Doosan DX 235LCR, P-P 464mm	121795-4220	330
Doosan DX 255LC/DX 255LC-5, P-P 488mm	121795-4221	333

EXCAVATOR MOUNTS CONTINUED NEXT PAGE

MULCHERS

MULCHERS FOR EXCAVATORS CONT.

EXCAVATOR MOUNTS CONT.	ORDER CODE	SHIP WEIGHT (LBS)
MM422 Series II Excavator Mounts - Contact Factory for Mounts Not Listed		
Doosan DX 300, P-P 508mm	121795-3290	373
Hitachi ZX 190W-3, P-P 472mm	121795-7201	323
Hitachi EX 200LC/EX 200LC-2/EX 200LC-3/EX 200LC-5, P-P 472mm	121795-7201	323
Hitachi ZX 200LC/ZX 200LC-3, P-P 472mm	121795-7201	323
Hitachi ZX 210LC-5, P-P 472mm	121795-7201	323
Hitachi ZX 210W, P-P 472mm	121795-7201	323
Hitachi EX 220LC-3, P-P 475mm	121795-7230	372
Hitachi ZX 220W-3, P-P 472mm	121795-7201	323
Hitachi ZX 225USLC/ZX 225USLC-3, P-P 472mm	121795-7201	323
Hitachi EX 230LC-5, P-P 475mm	121795-7230	372
Hitachi ZX 230LC, P-P 475mm	121795-7230	372
Hitachi ZX 240LC-3, P-P 475mm	121795-7230	372
Hitachi ZX 245USLC-5, P-P 472mm	121795-7201	323
Hitachi ZX 250LC-5, P-P 475mm	121795-7230	372
Hitachi EX 270LC-5, P-P 475mm	121795-7230	372
Hitachi ZX 270LC/ZX 270LC-3, P-P 475mm	121795-7230	372
Hitachi ZX 290LC-5, P-P 475mm	121795-7230	372
Hyundai R 200W-7/R 200W-7A, P-P 460mm	121795-4201	330
Hyundai HW 210, P-P 460mm	121795-4201	330
Hyundai R 210LC-7/R 210LC-7A/R 210LC-9, P-P 460mm	121795-4201	330
Hyundai R 210W-9/R 210W-9A, P-P 460mm	121795-4201	330
Hyundai HX 220L, P-P 460mm	121795-4201	330
Hyundai R 220LC-9A, P-P 460mm	121795-4201	330
Hyundai HX 235LCR, P-P 460mm	121795-4201	330
Hyundai R 235LCR-9/R 235LCR-9A, P-P 460mm	121795-4201	330
Hyundai R 250LC-7/R 250LC-7A/R 250LC-9, P-P 510mm	121795-1291	376
Hyundai HX 260L, P-P 510mm	121795-1291	376
Hyundai R 260LC-9A, P-P 510mm	121795-1291	376
Hyundai R 290LC-7/R 290LC-7A/R 290LC-9, P-P 510mm	121795-1291	376
Hyundai HX 300L, P-P 510mm	121795-1291	376
Hyundai R 300LC-9A, P-P 510mm	121795-1291	376
JCB JS 190, P-P 435mm	121795-9020	316
JCB JS 200, P-P 450mm	121795-9030	320
JCB JS 200W, P-P 450mm	121795-9030	320
JCB JS 210, P-P 450mm	121795-9030	320
JCB JS 220, P-P 450mm	121795-9030	320
JCB JS 235, P-P 450mm	121795-9030	320
JCB JZ 235, P-P 450mm	121795-9030	320
JCB JS 240, P-P 460mm	121795-9240	351
JCB JZ 255, P-P 450mm	121795-9030	320
JCB JS 260, P-P 460mm	121795-9240	351

EXCAVATOR MOUNTS CONTINUED NEXT PAGE

MULCHERS FOR EXCAVATORS CONT.

EXCAVATOR MOUNTS CONT.	ORDER CODE	SHIP WEIGHT (LBS)
MM422 Series II Excavator Mounts - Contact Factory for Mounts Not Listed		
John Deere 200 LC/200C LC/200D LC, P-P 472mm	121795-7201	323
John Deere 210G LC, P-P 472mm	121795-7201	323
John Deere 210C W, P-P 472mm	121795-7201	323
John Deere 220D W, P-P 472mm	121795-7201	323
John Deere 225C LC/225D LC, P-P 472mm	121795-7201	323
John Deere 230 LC/230C LC, P-P 475mm	121795-7230	372
John Deere 240D LC, P-P 475mm	121795-7230	372
John Deere 245G LC, P-P 472mm	121795-7201	323
John Deere 250G LC, P-P 475mm	121795-7230	372
John Deere 270 LC/270C LC/270D LC, P-P 475mm	121795-7230	372
John Deere 290G LC, P-P 475mm	121795-7230	372
John Deere 300G LC, P-P 475mm	121795-7230	372
John Deere 350D, P-P 585mm	121795-7330	434
Kobelco SK 200LC-MARK III/SK 200-3, P-P 430mm	121795-2200	316
Kobelco SK 210LC-6/SK 210LC-8/SK 210LC-9/SK 210LC-10, P-P 442mm	121795-2201	318
Kobelco SK 215SRLC, P-P 442mm	121795-2201	318
Kobelco SK 220LC MARK III, P-P 500mm	121795-2220	355
Kobelco SK 220LC MARK IV, P-P 514mm	121795-2221	358
Kobelco SK 230SRLC-3/SK 230SRLC-5, P-P 442mm	121795-2201	318
Kobelco SK 235SRLC, P-P 442mm	121795-2201	318
Kobelco SK 250LC-6, P-P 514mm	121795-2221	358
Kobelco SK 260LC-8/SK 260LC-9/SK 260LC-10, P-P 514mm	121795-2221	358
Kobelco SK 260SRLC-3, P-P 442mm	121795-2201	318
Kobelco SK 270LC MARK IV, P-P 514mm	121795-2221	358
Kobelco SK 270SRLC-5, P-P 442mm	121795-2201	318
Kobelco SK 290LC-6, P-P 527mm	121795-2290	375
Kobelco SK 295LC-8/SK 295LC-9, P-P 527mm	121795-2290	375
Kobelco SK 300LC-10, P-P 527mm	121795-2290	375
Komatsu PC 200LC-5/PC 200LC-6/PC 200LC-7/PC 200LC-8, P-P 458mm	121795-0200	322
Komatsu PC 210LC-10/PC 210LC-11, P-P 458mm	121795-0200	322
Komatsu HB 215LC-1, P-P 458mm	121795-0200	322
Komatsu PC 220LC-5/PC 220LC-6/PC 220LC-7/PC 220LC-8, P-P 446mm	121795-0220	320
Komatsu PC 228USLC-3/PC 228USLC-8/PC 228USLC-10, P-P 458mm	121795-0200	322
Komatsu PC 240LC-10/PC 240LC-11, P-P 446mm	121795-0220	320
Komatsu PC 250LC-6, P-P 446mm	121795-0220	320
Komatsu PC 270LC-6/PC 270LC-7/PC 270LC-8, P-P 446mm	121795-0220	320
Komatsu PC 290LC-10/PC 290LC-11, P-P 446mm	121795-0220	320
Komatsu PC 300 / PC 360, P-P 514mm	121795-0300	358

EXCAVATOR MOUNTS CONTINUED NEXT PAGE

MULCHERS

MULCHERS FOR EXCAVATORS CONT.

EXCAVATOR MOUNTS CONT.	ORDER CODE	SHIP WEIGHT (LBS)
MM422 Series II Excavator Mounts - Contact Factory for Mounts Not Listed		
Link-Belt 210 LX/210 X2/210 X3/210 X4, P-P 440mm	121795-2802	317
Link-Belt 225 SPIN ACE, P-P 440mm	121795-2802	317
Link-Belt 235 X3 SPIN ACE, P-P 440mm	121795-2802	317
Link-Belt 240 LX/240 X2, P-P 460mm	121795-9240	351
Link-Belt 250 X3/250 X4, P-P 460mm	121795-9240	351
Link-Belt 290 LX/290 X2, P-P 460mm	121795-9240	351
Link-Belt 300 X3/300 X4, P-P 460mm	121795-9240	351
Volvo EC 210/EC 210B/EC 210C, P-P 467mm	121795-4210	323
Volvo EC 220D/EC 220E, P-P 467mm	121795-4210	323
Volvo EW 230C, P-P 467mm	121795-4210	323
Volvo ECR 235C/ECR 235D/ECR 235E, P-P 467mm	121795-4210	323
Volvo EC 240B/EC 240C, P-P 506mm	121795-4240	373
Volvo EC 250D, P-P 506mm	121795-4240	373
Volvo EC 290/EC 290B/EC 290C, P-P 495mm	121795-5280	374
Volvo EC 300D, P-P 495mm	121795-5280	374
Volvo S1 MOUNTING	121795-2141	371
MM601 Series II Excavator Mounts - Contact Factory for Mounts Not Listed		
Case CX 210/CX 210B/CX 210C/CX 210D, P-P 450mm	121794-9030	327
Case CX 225 MSR, P-P 450mm	121794-9030	327
Case CX 235C SR, P-P 450mm	121794-9030	327
Case CX 240/CX 240B, P-P 490mm	121794-9040	362
Case CX 250C/CX 250D, P-P 490mm	121794-9040	362
Caterpillar 316E/316F, P-P 463mm	121794-0315	283
Caterpillar M316D/M316F, P-P 463mm	121794-0315	283
Caterpillar 318B/318C, P-P 445mm	121794-0320	327
Caterpillar 318B/318C, P-P 485mm	121794-0322	332
Caterpillar 318E/318F, P-P 463mm	121794-0315	283
Caterpillar M318C/M318D, P-P 445mm	121794-0320	327
Caterpillar M318C/M318D, P-P 485mm	121794-0322	332
Caterpillar M318F, P-P 463mm	121794-0315	283
Caterpillar 319D, P-P 445mm	121794-0320	327
Caterpillar 319D, P-P 485mm	121794-0322	332
Caterpillar 320/320B/320C/320D/320E/320F, P-P 445mm	121794-0320	327
Caterpillar 320/320B/320C/320D/320E/320F, P-P 485mm	121794-0322	332
Caterpillar M320F, P-P 445mm	121794-0320	327
Caterpillar M320F, P-P 485mm	121794-0322	332
Caterpillar 321C/321D, P-P 445mm	121794-0320	327
Caterpillar 321C/321D, P-P 485mm	121794-0322	332
Caterpillar 322/322B/322C, P-P 485mm	121794-0322	332
Caterpillar 322/322B/322C, P-P 512mm	121794-2322	336
Caterpillar M322C/M322D, P-P 445mm	121794-0320	327
Caterpillar M322C/M322D, P-P 485mm	121794-0322	332
Caterpillar 323D/323E/323F, P-P 445mm	121794-0320	327
Caterpillar 323D/323E/323F, P-P 485mm	121794-0322	332
Caterpillar 324D/324E, P-P 485mm	121794-0324	362
Caterpillar 324D/324E, P-P 512mm	121794-0324	362

EXCAVATOR MOUNTS CONTINUED NEXT PAGE

MULCHERS FOR EXCAVATORS CONT.

EXCAVATOR MOUNTS CONT.	ORDER CODE	SHIP WEIGHT (LBS)
MM601 Series II Excavator Mounts - Contact Factory for Mounts Not Listed		
Doosan DX 180LC/DX 180LC-3/DX 180LC-5, P-P 464mm	121794-4220	338
Doosan DX 190W-3/DX 190W-5, P-P 464mm	121794-4220	338
Doosan DX 210W/DX 210W-5, P-P 464mm	121794-4220	338
Doosan DX 225LC/DX 225LC-3/DX 225LC-5, P-P 464mm	121794-4220	338
Doosan DX 235LCR, P-P 464mm	121794-4220	338
Hitachi EX 160LC-5, P-P 391mm	121794-7150	316
Hitachi ZX 160LC/ZX 160LC-3/ZX 160LC-5, P-P 391mm	121794-7150	316
Hitachi ZX 180LC-5, P-P 472mm	121794-7201	331
Hitachi ZX 180W, P-P 472mm	121794-7201	331
Hitachi ZX 190W-3, P-P 472mm	121794-7201	331
Hitachi EX 200LC/EX 200LC-2/EX 200LC-3/EX 200LC-5, P-P 472mm	121794-7201	331
Hitachi ZX 200LC/ZX 200LC-3, P-P 472mm	121794-7201	331
Hitachi ZX 210LC-5, P-P 472mm	121794-7201	331
Hitachi ZX 210W, P-P 472mm	121794-7201	331
Hitachi EX 220LC-3, P-P 475mm	121794-7230	385
Hitachi ZX 220W-3, P-P 472mm	121794-7201	331
Hitachi ZX 225USLC/ZX 225USLC-3, P-P 472mm	121794-7201	331
Hitachi EX 230LC-5, P-P 475mm	121794-7230	385
Hitachi ZX 230LC, P-P 475mm	121794-7230	385
Hitachi ZX 240LC-3, P-P 475mm	121794-7230	385
Hitachi ZX 245USLC-5, P-P 472mm	121794-7201	331
Hitachi ZX 250LC-5, P-P 475mm	121794-7230	385
Hyundai HX 160L, P-P 410mm	121794-2180	275
Hyundai R 160LC-7/R 160LC-7A/R 160LC-9/R 160LC-9A, P-P 410mm	121794-2180	275
Hyundai R 170W-7/R 170W-7A/R 170W-9, P-P 410mm	121794-2180	275
Hyundai HW 180, P-P 410mm	121794-2180	275
Hyundai HX 180L, P-P 410mm	121794-2180	275
Hyundai R 180LC-7/R 180LC-7A/R 180LC-9/R 180LC-9A, P-P 410mm	121794-2180	275
Hyundai R 200W-7/R 200W-7A, P-P 460mm	121794-4201	337
Hyundai HW 210, P-P 460mm	121794-4201	337
Hyundai R 210LC-7/R 210LC-7A/R 210LC-9, P-P 460mm	121794-4201	337
Hyundai R 210W-9/R 210W-9A, P-P 460mm	121794-4201	337
Hyundai HX 220L, P-P 460mm	121794-4201	337
Hyundai R 220LC-9A, P-P 460mm	121794-4201	337
Hyundai HX 235LCR, P-P 460mm	121794-4201	337
Hyundai R 235LCR-9/R 235LCR-9A, P-P 460mm	121794-4201	337
JCB JS 160, P-P 435mm	121794-9020	324
JCB JS 160W, P-P 435mm	121794-9020	324
JCB JS 175W, P-P 435mm	121794-9020	324
JCB JS 180, P-P 435mm	121794-9020	324
JCB JS 190, P-P 435mm	121794-9020	324
JCB JS 200, P-P 450mm	121794-9030	327
JCB JS 200W, P-P 450mm	121794-9030	327
JCB JS 210, P-P 450mm	121794-9030	327
JCB JS 220, P-P 450mm	121794-9030	327

EXCAVATOR MOUNTS CONTINUED NEXT PAGE

MULCHERS

MULCHERS FOR EXCAVATORS CONT.

EXCAVATOR MOUNTS CONT.	ORDER CODE	SHIP WEIGHT (LBS)
MM601 Series II Excavator Mounts - Contact Factory for Mounts Not Listed		
JCB JS 235, P-P 450mm	121794-9030	327
JCB JZ 235, P-P 450mm	121794-9030	327
JCB JS 240, P-P 460mm	121794-9240	358
JCB JZ 255, P-P 460mm	121794-9030	327
John Deere 160 LC/160C LC/160D LC/160G LC, P-P 391mm	121794-7150	316
John Deere 180G LC, P-P 472mm	121794-7201	331
John Deere 180C W, P-P 472mm	121794-7201	331
John Deere 190D W/190G W, P-P 472mm	121794-7201	331
John Deere 200 LC/200C LC/200D LC, P-P 472mm	121794-7201	331
John Deere 210G LC, P-P 472mm	121794-7201	331
John Deere 210C W, P-P 472mm	121794-7201	331
John Deere 220D W, P-P 472mm	121794-7201	331
John Deere 225C LC/225D LC, P-P 472mm	121794-7201	331
John Deere 230 LC/230C LC, P-P 475mm	121794-7230	385
John Deere 240D LC, P-P 475mm	121794-7230	385
John Deere 245G LC, P-P 472mm	121794-7201	331
John Deere 250G LC, P-P 475mm	121794-7230	385
Kobelco SK 160LC-6, P-P 411mm	121794-2151	275
Kobelco SK 170LC-8/SK 170LC-9/SK 170LC-10, P-P 411mm	121794-2151	275
Kobelco ED 190-6, P-P 411mm	121794-2151	275
Kobelco ED 195-8, P-P 411mm	121794-2151	275
Kobelco SK 200LC-MARK III/SK 200-3, P-P 430mm	121794-2200	323
Kobelco SK 200LC MARK IV, P-P 442mm	121794-2201	325
Kobelco SK 200SRLC, P-P 442mm	121794-2201	325
Kobelco SK 210LC-6/SK 210LC-8/SK 210LC-9/SK 210LC-10, P-P 442mm	121794-2201	325
Kobelco SK 215SRLC, P-P 442mm	121794-2201	325
Kobelco SK 220LC MARK III, P-P 500mm	121794-2220	363
Kobelco SK 220LC MARK IV, P-P 514mm	121794-2221	365
Kobelco SK 230SRLC-3/SK 230SRLC-5, P-P 442mm	121794-2201	325
Kobelco SK 235SRLC, P-P 442mm	121794-2201	325
Kobelco SK 250LC-6, P-P 514mm	121794-2221	365
Komatsu PC 160LC-7/PC 160LC-8, P-P 401mm	121794-0150	274
Komatsu PC 170LC-10, P-P 401mm	121794-0150	274
Komatsu PW 170ES-6, P-P 401mm	121794-0150	274
Komatsu PC 180LC-7, P-P 401mm	121794-0150	274
Komatsu PC 200LC-5/PC 200LC-6/PC 200LC-7/PC 200LC-8, P-P 458mm	121794-0200	328
Komatsu PC 210LC-10/PC 210LC-11, P-P 458mm	121794-0200	328
Komatsu HB 215LC-1, P-P 458mm	121794-0200	328
Komatsu PC 220LC-5/PC 220LC-6/PC 220LC-7/PC 220LC-8, P-P 446mm	121794-0220	329
Komatsu PC 228USLC-3/PC 228USLC-8/PC 228USLC-10, P-P 458mm	121794-0200	328
Komatsu PC 240LC-10/PC 240LC-11, P-P 446mm	121794-0220	329

EXCAVATOR MOUNTS CONTINUED NEXT PAGE

MULCHERS FOR EXCAVATORS CONT.

EXCAVATOR MOUNTS CONT.	ORDER CODE	SHIP WEIGHT (LBS)
MM601 Series II Excavator Mounts - Contact Factory for Mounts Not Listed		
Link-Belt 160 LX/160 X2/160 X3/160 X4, P-P 435mm	121794-9020	324
Link-Belt 210 LX/210 X2/210 X3/210 X4, P-P 440mm	121794-2802	324
Link-Belt 225 SPIN ACE, P-P 440mm	121794-2802	324
Link-Belt 235 X3 SPIN ACE, P-P 440mm	121794-2802	324
Link-Belt 240 LX/240 X2, P-P 460mm	121794-9240	358
Link-Belt 250 X3/250 X4, P-P 460mm	121794-9240	358
Volvo EC 160B/EC 160C, P-P 440mm	121794-5160	280
Volvo EC 160D, P-P 423mm	121794-5150	277
Volvo EW 160C/EW 160D, P-P 440mm	121794-5160	280
Volvo EW 170, P-P 423mm	121794-2170	278
Volvo EC 180C, P-P 440mm	121794-5160	280
Volvo EC 180D, P-P 423mm	121794-5150	277
Volvo EW 180/EW 180C/EW 180D, P-P 423mm	121794-2170	278
Volvo EC 210/EC 210B/EC 210C, P-P 467mm	121794-4210	331
Volvo EW 210C/EW 210D, P-P 423mm	121794-2170	278
Volvo EC 220D/EC 220E, P-P 467mm	121794-4210	331
Volvo EW 230C, P-P 467mm	121794-4210	331
Volvo ECR 235C/ECR 235D/ECR 235E, P-P 467mm	121794-4210	331
Volvo EC 240B/EC 240C, P-P 506mm	121794-4240	383
Volvo EC 250D, P-P 506mm	121794-4240	383
Volvo S1 MOUNTING	121794-2141	382

MULCHERS

FD60 FORESTRY DISK MULCHER



- Designed to reduce jamming
- Ultra-efficient drive system with fast start
- MulchPower™ Gauge for maximum energy
- Bearing housing never needs to be greased
- Debris shovel keeps teeth out of the dirt and guides material for processing
- High-quality QUADCO teeth are interchangeable, allowing for simple service and rotation
- Fells trees up to 14"
- Processes up to 8"
- Stump grinds to grade

Specifications				
FLOW RANGE	OPERATING PRESSURE	HEIGHT	OVERALL WIDTH	LENGTH
30 - 45 GPM	3,300 minimum	39.5"	75.75"	75.5"

FORESTRY DISK MULCHER FOR SKID-STEER LOADERS



MULCHER ASSEMBLY	ORDER CODE	SHIP WEIGHT (LBS)
FD60 60" Forestry Disk Mulcher, 1/2" QD, Case Drain	125260-0022	2217
FD60 60" Forestry Disk Mulcher, 5/8" QD, Case Drain	125260-9903	2217
FD60 60" Forestry Disk Mulcher, 3/4" QD, Case Drain	125260-9925	2217

REPLACEMENT PARTS	ORDER CODE	SHIP WEIGHT (LBS)
Partial Tooth Replacement Kit (20 Teeth and Hardware)	125288	30.5
Tooth - Individual	124861	1
Tooth Bolt 3.50" - Individual	10322	1
Tooth Bolt 4.00" - Individual	10323	1
Skid Shoe Replacement Kit - Right Side	125984	15
Skid Shoe Replacement Kit - Left Side	125985	15
Debris Shovel Replacement Kit	125986	85
Swinging Debris Door Replacement Kit	125959	40
Hose w/Sock .38x112 6FJ-8MB 100R2AT HS	38162	4
Hose w/Sock .75x108 12FJ-12MB 4K HS	37769	2
Hose Coupler .38" body female QD 6 FF F 8FB	84928	1
Hose Coupler .38" body male QD 6 FF M 8FB	84923	1
Hose Coupler .50" body female QD 8 FF F 12FB	22518	2
Hose Coupler .50" body female QD 8 FF M 12FB	22519	2
Hose Coupler .625" body female QD 10 FF F 12FB	84921	3
Hose Coupler .625" body male QD 10 FF M 12FB	84922	3
Hose Coupler .75" body female QD 12 FF F 12FB	22520	2
Hose Coupler .75" body male QD 12 FF M 12FB	22521	3

POST DRIVER



- Manual side shift
- Operates off skid-steer hydraulics
- Does not mushroom posts
- No shock load back to skid steer
- Optional striker plates to match post shape

Specifications				
Model	Weight (approx)	Width	Height	Hydraulic Flow
PD4800	1360 lbs	54.25"	91.48"	24 gpm

POST DRIVER FOR SKID-STEER LOADERS



TO ORDER: CHOOSE POST DRIVER, COLLAR ASSEMBLY AND HOSE KIT TO MATCH YOUR SKID-STEER.

POST DRIVER (NO HOSES)	ORDER CODE	SHIP WEIGHT (LBS)
PD4800 post driver	111487	1360

COLLAR ASSEMBLY WITH STRIKER PLATES (ONE REQUIRED)	ORDER CODE	SHIP WEIGHT (LBS)
3.5" square collar with striker plate assembly	112493	63
6.0" square collar with striker plate assembly	112492	65
8.0" square collar with striker plate assembly	112491	66
6" x 8" square collar with striker plate assembly	112494	64

HOSE KITS	ORDER CODE	SHIP WEIGHT (LBS)
80" with .50" body flat face couplers	112919	25
108" with .50" body flat face couplers	112920	30
tilt attach hose kit complete with valve package (requires BRADCO TILT-A-TACH)	112921	25

OPTIONS	ORDER CODE	SHIP WEIGHT (LBS)
Collars		
3" round collar	19964	15
3.5" square collar	88812	15
4" round collar	19965	15
4" x 6" "H" beam	88815	15
6" round collar	88813	15
8" square collar	32712	15
6" x 8" collar	89147	15
6" square collar	89413	15
T post Adapter	87122	15
Tilt Attach Assy, HD	17446	386
universal valve package (required for Tilt Attach)	88725	23
Control box w/ power lead (required for Tilt Attach)	28-10754	5

POST DRIVER CONTROLS CONTINUED NEXT PAGE

POST DRIVER

POST DRIVER FOR SKID-STEER LOADERS CONT.

HYDRAULIC CONTROL AND WIRE HARNESS OPTIONS	ORDER CODE	SHIP WEIGHT (LBS)
universal valve package (required for Tilt Attach)	88725	23
Control box w/ power lead (required for Tilt Attach)	28-10754	5
Control box w/ power lead	28-10754	5
Wire harness for CAT pre-B (8-pin Deutsch)	07-10021	5
Wire harness for CAT (14-pin "D" series)	07-8344	5
Wire harness for standard flow attachments on CAT B and C (8-pin Deutsch)	07-10122	5
Wire Harness (multi function in cab controls) for CNH, JCB, Bobcat, Mustang, Kubota, Takeuchi, Volvo 14 Pin-8 Pin	LAF9360-0000	5
Wire harness for CNH (8-pin rectangular)	LAF9393	5
Wire harness for John Deere (3-pin Deutsch)	07-7338	5
Wire harness for John Deere-8 button (14-pin Deutsch)	LAF9361	5
Wire harness for John Deere EH control (14-pin Deutsch)	07-7626	5
Wire harness for Komatsu (14-pin Deutsch)	07-10194	5
Wire harness for Komatsu (8-pin Deutsch)	07-10057	5
Extension		
60" extension	07-7887	2

RAKES



RAKES

AUTORAKE



- Grooms and finishes soil for seeding and sodding
- Picks up rocks from .75" to 6" in diameter and collects them in the hopper
- Breaks up clods and levels soils
- Easy to dump collected debris, simply raise the loader arms and open shroud hydraulically

Carrier Specifications	
Lift Capacity	Operating Weight
<9,000 lbs.	<11,000 lbs.

Specifications					
Model #	Approx. Weight	Working Width	Hopper Capacity	PSI Range	GPM Range
LAF6864	1350 lbs	62"	.48 yd ³	1000-3500	10-25
LAF6874	1455 lbs	72"	.56 yd ³	1000-3500	10-25

AUTORAKE FOR SKID-STEER LOADERS



**INCLUDES: AUTORAKE AND UNIVERSAL SSL MOUNTING
TO ORDER: CHOOSE AUTORAKE AND MOUNTING**

AUTORAKE CHECK LOADER CAPACITY BEFORE ORDERING		ORDER CODE	SHIP WEIGHT (LBS)
62" AutoRake		LAF6864	1495
72" AutoRake		LAF6874	1695

MOUNTING ADDITIONAL COST MAY APPLY		ORDER CODE	SHIP WEIGHT (LBS)
Universal SSL Mount		0022	N/A

PREPARATOR



- Efficiently handles clean-up, rock removal and soil preparation
- Follows ground contour while picking up rocks and debris
- Picks up rocks 1" to 20" in diameter
- Bi-directional drum tills up to 2.5" deep

Specifications						
Model	Weight (approx)	Working Width	Overall Width	Capacity Struck	PSI Range	GPM Range
LAF3566	1445 lbs	66"	74"	.38 yd ³	2000-3500	10-25
LAF3576	1565 lbs	76"	84"	.46 yd ³	2000-3500	10-25

Tooth Chart - Quantity needed		
Type	Inside Teeth	Outside Teeth
LAF3554	240	10
LAF3566	300	10
LAF3576	350	10

IMPORTANT: All replacement hydraulic hoses and fittings must have a minimum rated working pressure of 4000 psi.

Carrier Specifications	
Lift Capacity	Operating Weight
<9,000 lbs.	<11,000 lbs.

PREPARATOR FOR SKID-STEER LOADERS



INCLUDES: PREPARATOR AND UNIVERSAL SSL MOUNTING TO ORDER: CHOOSE PREPARATOR AND MOUNTING

PREPARATOR	ORDER CODE	SHIP WEIGHT (LBS)
CHECK LOADER CAPACITY BEFORE ORDERING		
66" Working Width Preparator	LAF3566-0022	1500
76" Working Width Preparator	LAF3576-0022	1650

MOUNTING	ORDER CODE	SHIP WEIGHT (LBS)
ADDITIONAL COST MAY APPLY		
Contact Customer Service at (833) 723-1843		

REPLACEMENT PARTS	ORDER CODE	SHIP WEIGHT (LBS)
Inside Tooth for Preparator - See chart for quantity needed	ILA9907-0000	1
Outside Tooth for Preparator- See chart for quantity needed	ILA9906-0000	1
FFC Preparator Decal Kit	28-10572	1
Replaceable Drum		
Replaceable Drum for LAF3554	LAF3591-0000	236
Replaceable Drum for LAF3566	LAF3505-0000	278
Replaceable Drum for LAF3576	LAF3506-0000	313

RAKES

POWER BOX RAKE

NEW PRODUCT



- Solid tires eliminate flats to maximize uptime and productivity on debris-heavy jobsites
- Bi-directional motor allows the drum to rotate in either direction maximizing flexibility
- Pure carbide teeth design - specially shaped to ensure the best possible seedbed sub-base fracture pattern and superior moisture retention and release
- The box-end plates are engineered for quick and easy removal, enabling windrowing and reverse box raking without the need for bolts. Simply pull the pins to detach them
- Dual independently adjustable gauge wheels allow for skim passes for seeding - or - adjust to grade and contour

Specifications	MX5	MX6	MX7	MX8
OVERALL HEIGHT	32.9 IN.	33.2 IN.	33.2 IN.	37.3 IN.
OVERALL WIDTH	71.7 IN.	81.7 IN.	93.6 IN.	100.7 IN.
OVERALL LENGTH	60.8 IN.	60.8 IN.	60.8 IN.	67.8 IN.
RAKING WIDTH	62 IN.	72 IN.	84 IN.	90 IN.
OVERALL LENGTH @ 20°	67.1 IN.	68.6 IN.	70.8 IN.	77.8 IN.
OVERALL WIDTH @ 20°	71.1 IN.	80.4 IN.	91.7 IN.	97.8 IN.
RAKING WIDTH @ 20°	60.4 IN.	69.8 IN.	81.1 IN.	86.9 IN.
CENTER OF GRAVITY - MANUAL ANGLE	21.8 IN.	21.9 IN.	21.9 IN.	23.7 IN.
CENTER OF GRAVITY - HYDRAULIC ANGLE	21.4 IN.	21.6 IN.	21.6 IN.	23.3 IN.
WEIGHT - MANUAL ANGLE	900 LBS	954 LBS	1000 LBS	1120 LBS
WEIGHT - HYDRAULIC ANGLE	937 LBS	993 LBS	1037 LBS	1150 LBS
FLOW RANGE	13 - 20 GPM	13 - 25 GPM	15 - 25 GPM	17 - 40 GPM
HYD. MOTOR DISP. (C.I.)	12.3	12.5	15	15
# OF MOTORS	1	1	1	1
MAX PRESSURE (PSI)	3000 PSI	3000 PSI	3000 PSI	3000 PSI
MAX ARTICULATION	20°	20°	20°	20°
RAKE TOOTH TIP DIAMETER	9 IN.	9 IN.	9 IN.	9 IN.

HARLEY MX SERIES POWER RAKES FOR SKID-STEER LOADERS



SKID-STEER WITH A RATED OPERATING CAPACITY >1,500 LBS	ORDER CODE	SHIP WEIGHT (LBS)
MX5 (manual)	25260M-0022	1000
MX5 (hydraulic)	25260H-0022	1037
MX6 (manual)	25272M-0022	1054
MX6 (hydraulic)	25272H-0022	1093
MX7 (manual)	25284M-0022	1100
MX7 (hydraulic)	25284H-0022	1137
MX8 (manual)	25296M-0022	1220
MX8 (hydraulic)	25296H-0022	1250

CONTROLS AND REPLACEMENT PARTS CONTINUED NEXT PAGE

POWER BOX RAKE CONT.

HARLEY POWER BOX RAKE FOR SKID-STEER LOADERS

HYDRAULIC CONTROL AND WIRE HARNESS OPTIONS (MUST CHOOSE ONE)	ORDER CODE	SHIP WEIGHT (LBS)
Control box w/ power lead	28-10754	5
7-pin for Bobcat, fits Rakes with Hydraulic Angle*	07-9548	5
Wire harness for CAT (14-pin "D" series)	07-8344	5
Wire harness for CAT pre-B (8-pin Deutsch)	07-10021	5
Wire harness for standard flow attachments on CAT B and C (8-pin Deutsch)	07-10122	5
Wire harness for John Deere-8 button (14-pin Deutsch)	LAF9361	5
Wire harness for John Deere EH control (14-pin Deutsch)	07-7626	5
Wire harness for John Deere (3-pin Deutsch)	07-7338	5
Wire harness for Komatsu (14-pin Deutsch)	07-10194	5
Wire harness for Komatsu (8-pin Deutsch)	07-10057	5
Wire Harness (multi function in cab controls) for CNH, JCB, Bobcat, Mustang, Kubota, Takeuchi, Volvo 14 Pin-8 Pin	LAF9360-0000	5
Wire harness for CNH (8-pin rectangular)	LAF9393	5
Extension		
60" extension	07-7887	2

*7 Pin Bobcat harness will not work with the Bobcat Toolcat, Versahandler or hand/foot control machines. There is no current harness offering for these machines.

REPLACEMENT PARTS	ORDER CODE	SHIP WEIGHT (LBS)
Carbide Tooth - All Models - Qty 1	M6774C	
Carbide Tooth - All Models - Qty 3	M6774-3	
Carbide Tooth - All Models - Qty 10	M3774-10	
ASSY TIRE/WHL/HUB 13 X 500-6 2PLY - Model MX4	P752100	
ASSY TIRE/WHL/HUB/BRG/AXLE BOLT/SPACERS - Models MX5, MX6, MX7 & MX8	M16114	
ASSY CASTER HUB - Models MX5, MX6, MX7 & MX8	M16120	
Hydraulic Cylinder Swing Angle - M4H	03-5727	
Hydraulic Cylinder Swing Angle - MX5H, MX6H, MX7H & MX8H	03-5728	
Quick Disconnect Kit	28-9570	
Supply or Return Hose - Manual Angle - Model M4	03-6744	
Supply Hose - Hydraulic Angle - Model M4H	03-6744	
Return Hose - Hydraulic Angle - Model M4H	03-6742	
Supply and Return Hose - Manual Angle - Models MX5, MX6, MX7 & MX8	28-11453-X*	
Supply and Return Hose - Hydraulic Angle - Models MX5, MX6, MX7 & MX8	28-11454-X*	
Return Hose - Hydraulic Angle - Models MX5, MX6, MX7 & MX8	P255716	

**"X" being the model width, such as 5, 6, 7, or 8

RAKES

HARLEY POWER BOX RAKE FOR TRACTORS - 3 POINT



RAKES

Specifications

Model	Weight (lbs)	HP Range	Working Width - Straight	Working Width @ 15°	3-pt Category
TM4	550	15-22	48"	46"	1
TM5	575	18-32	60"	58"	1
T6	830	30-40	72"	69"	1
TM7	1260	42-80	84"	79"	1.2
TM8	1290	42-80	90"	85"	1.2

US PATENT NO. 6,578,295	ORDER CODE	SHIP WEIGHT (LBS)
TM-4 (manual)	TM4M-0052	537
TM-4 (hydraulic)	TM4H-0052	537
TM-5 (manual)	TM5M-0052	564
TM-5 (hydraulic)	TM5H-0052	564
T6 (manual)	T6M-0052	871
T6 (hydraulic)	T6H-0052	871
TM-7 (hydraulic)	TM7H-0052	1323
TM-8 (hydraulic)	TM8H-0052	1380

REPLACEMENT PARTS	ORDER CODE	SHIP WEIGHT (LBS)
Carbide Tooth - All Models - Qty 1	M6774C	
Carbide Tooth - All Models - Qty 3	M6774-3	
Carbide Tooth - All Models - Qty 10	M3774-10	
ASSY TIRE/WHL/HUB 13 X 500-6 2PLY - Model TM4 & TM5	P752100	
ASSY TIRE/WHL/HUB/BRG/AXLE BOLT/SPACERS - Models TM6, TM7 & TM8	M16114	
ASSY CASTER HUB - Models M5, M6 & MX7	M16120	
Hydraulic Cylinder, Swing Angle - TM6	03-5726	
Hydraulic Cylinder, Swing Angle - TM4 & TM5	03-5727	
Hydraulic Cylinder, Swing Angle - TM7 & TM8	03-5728	
QD Coupler 8010-4P, Models TM4, TM5 & TM6 - Qty 1	P272600	
Hose, Cylinder Models TM4, TM5, & TM6 - Qty 1	P246472	
QD Coupler 6610-10-10, Models TM7 & TM8 - Qty 1	P272661	
Hose, Cylinder, Models TM7 & TM8 - Qty 1	P248072	

POWER BOX RAKE - DIRECT DRIVE



- Pulverizes soil, removes debris, finish-grades, spreads fill or soil and dethatches
- Direct-drive motor eliminates chains and sprockets, reducing maintenance
- Heavy-duty frame and carbide teeth increases durability
- 8.6" bi-directional drum works soil forward and backward
- Wheel arms pivot and store in a vertical position

Specifications							
Model #	Approx. Weight	Width OD	Working Width	Height	Drum Torque @2500 PSI	PSI Range	GPM Range
LAF5672 & LAF5672H	1050 lbs	83.0"	72"	30.3"	605 ft-lb	2000-3500	12-40
LAF5690 & LAF5690H	1110 lbs	101.0"	90"	30.3"	605 ft-lb	2000-3500	12-40

Carrier Specifications	
Lift Capacity	Operating Weight
<9,000 lbs.	<11,000 lbs.



IMPORTANT: All replacement hydraulic hoses and fittings must have a minimum rated working pressure of 4000 psi.

DIRECT DRIVE POWER BOX RAKE FOR SKID-STEER LOADERS



INCLUDES: POWER BOX RAKE AND UNIVERSAL SSL MOUNTING (HOSES AND COUPLERS INCLUDED FOR SKID-STEERS ONLY. TO ORDER: CHOOSE POWER BOX RAKE, MOUNTING, AND HYDRAULIC CONTROL AND WIRE HARNESS

POWER BOX RAKE - DIRECT DRIVE SKID STEERS WITH A RATED OPERATING CAPACITY <5,000 LBS		ORDER CODE	SHIP WEIGHT (LBS)
Power Box Rake - Direct Drive with Manual Angle			
72" working width PowerRake		LAF5672-0022	1071
90" working width PowerRake		LAF5690-0022	1153
Power Box Rake - Direct Drive with Hydraulic Angle Kit (factory installed)			
72" working width PowerRake		LAF5672H-0022	1071
90" working width PowerRake		LAF5690H-0022	1153
MOUNTING - ADDITIONAL COST MAY APPLY		ORDER CODE	SHIP WEIGHT (LBS)
Contact Customer Service at (833) 723-1843			
HYDRAULIC CONTROL AND WIRE HARNESS OPTIONS		ORDER CODE	SHIP WEIGHT (LBS)
Control box w/ power lead		28-10754	5
Wire harness for CAT pre-B (8-pin Deutsch)		07-10021	5
Wire harness for CAT (14-pin "D" series)		07-8344	5
Wire harness for standard flow attachments on CAT B and C (8-pin Deutsch)		07-10122	5
Wire Harness (multi function in cab controls) for CNH, JCB, Bobcat, Mustang, Kubota, Takeuchi, Volvo 14 Pin-8 Pin		LAF9360-0000	5
Wire harness for CNH (8-pin rectangular)		LAF9393	5
Wire harness for John Deere (3-pin Deutsch)		07-7338	5
Wire harness for John Deere-8 button (14-pin Deutsch)		LAF9361	5
Wire harness for John Deere EH control (14-pin Deutsch)		07-7626	5
Wire harness for Komatsu (14-pin Deutsch)		07-10194	5
Wire harness for Komatsu (8-pin Deutsch)		07-10057	5
Extension			
60" extension		07-7887	2
OPTIONAL - ADDITIONAL PARTS		ORDER CODE	SHIP WEIGHT (LBS)
Hydraulic angle kit f/72" & 90"		LAF5650-0000	35

RAKES

POWER BOX RAKE - DIRECT DRIVE CONT.

DIRECT DRIVE POWER BOX RAKE FOR SKID-STEER LOADERS

REPLACEMENT PARTS	ORDER CODE	SHIP WEIGHT (LBS)
Carbide Tooth - All Models - Qty 1	M6774C	
Carbide Tooth - All Models - Qty 3	M6774-3	
Carbide Tooth - All Models - Qty 10	M3774-10	
ASSY TIRE/WHL/HUB/BRG/AXLE BOLT/SPACERS - Direct Drive Models	M16114	
ASSY CASTER HUB - Direct Drive Models	M16120	
Hydraulic Cylinder Swing Angle - Direct Drive Models	03-5724	
Hydraulic Hose Supply & Return - Direct Drive M Models - Qty 1	LAF4680-0000	
Hydraulic Hose Supply - Direct Drive H Models - Qty 1	LAF4680-0000	
Hydraulic Hose Return - Direct Drive H Models - Qty 1	LAF4658-0000	

RAKES

ROOT RAKE

NEW PRODUCT



- Remove the toil and leave the soil
- Replaceable pin-on H&L-230 style teeth for durability and extended life
- Zinc plated, greaseable, pivot pins with protected grease zerks, and replaceable hardened steel bushings
- Comes standard with 85" hoses and 1/2" quick couplers

Specifications							
Rake Width	Width (overall Grapple)	Height (overall)	Grapple Opening	Tooth Position	Length (overall)	Weight (lbs) varies depending on mount	Tine Spacing
72"	70"	38.76"	51"	27"	31.72"	1110	10.13"
78"	70"	38.76"	51"	27"	31.72"	1130	10.13"
84"	70"	38.76"	51"	27"	31.72"	1225	10.13"

ROOT RAKES FOR SKID-STEER LOADERS



ROOT RAKE	ORDER CODE	SHIP WEIGHT (LBS)
72" Root Rake Assembly	31972-0022	1110
78" Root Rake Assembly	31978-0022	1130
84" Root Rake Assembly	31984-0022	1225

REPLACEMENT PARTS	ORDER CODE	SHIP WEIGHT (LBS)
Bucket Tooth - HL23 Series, Cast	88893	3.2
Flex Pin	88894	0.1

ROOT RAKES CONTINUED NEXT PAGE

RAKES

ROOT RAKE CONT.

ROOT RAKES FOR COMPACT TRACTORS



INCLUDES: ROOT RAKE AND MOUNT AS INDICATED

ROOT RAKE	ORDER CODE	SHIP WEIGHT (LBS)
60" Root Rake - Universal SSL Mount	109982	413
66" Root Rake - Universal SSL Mount	109983	439
72" Root Rake - JD400 Mount	113088	446
72" Root Rake - Pin-on Mount	112606	446
72" Root Rake - Universal SSL Mount	109984	448

HOSE KITS	ORDER CODE	SHIP WEIGHT (LBS)
76" hoses w/ .50" Flat Face Couplers	121151	15
84" hoses w/ .50" Flat Face Couplers	121152	18
96" hoses w/ .50" Flat Face Couplers and 90° fittings	121084	20

ROOT RAKES FOR COMPACT WHEEL LOADERS



INCLUDES: ROOT RAKE AND COMPACT WHEEL LOADER MOUNT

ROOT RAKE	ORDER CODE	SHIP WEIGHT (LBS)
72" Root Rake Assembly for Takeuchi TW50-TW65-TW80 Combo Mount	107332	1200
72" Root Rake Assembly for JCB 406, 407 / CASE 321F / NH W50C / ZTL-Meyer 402 Mount	117036	1130
72" Root Rake Assembly for Case 221D / NH LW80	12843	1150
72" Root Rake Assembly for Volvo L30-35	124703	1150
78" Root Rake Assembly for Volvo L30	13179	1140
78" Root Rake Assembly for Kawasaki 45ZV-2	13391	1250
84" Root Rake Assembly for Takeuchi TW65 - TW80	108125	1250
84" Root Rake Assembly for CAT IT / TH	120300	1250
84" Root Rake Assembly for JD244J / VOLVO L35	13269	1350

REPLACEMENT PARTS	ORDER CODE	SHIP WEIGHT (LBS)
Bucket Tooth - HL23 Series, Cast	88893	3.2
Flex Pin	88894	0.1

ROOT RAKE CONT.

ROOT RAKES FOR EURO/GLOBAL MOUNTS



INCLUDES: ROOT RAKE AND MOUNT AS INDICATED

ROOT RAKE	ORDER CODE	SHIP WEIGHT (LBS)
72" Root Rake Assembly - Euro Global Mount	114061	1100
84" Root Rake Assembly - Euro Global Mount	111410	1225

REPLACEMENT PARTS	ORDER CODE	SHIP WEIGHT (LBS)
Bucket Tooth - HL23 Series, Cast	88893	3.2
Flex Pin	88894	0.1

ROOT RAKES FOR TRACTOR LOADERS/BACKHOES



INCLUDES: ROOT RAKE AND UNIVERSAL SSL MOUNTING TO ORDER: CHOOSE ROOT RAKE AND HOSE KIT



IMPORTANT: Due to the variances between different makes and models, Root Rakes for SSL do not include hoses and couplers. They must be ordered separately.

ROOT RAKE	ORDER CODE	SHIP WEIGHT (LBS)
84" Root Rake Assembly, QCP 7000/NH LB75B	12846	1475

HOSE KITS	ORDER CODE	SHIP WEIGHT (LBS)
76" hoses w/ .50" Flat Face Couplers	121151	15
84" hoses w/ .50" Flat Face Couplers	121152	18
96" hoses w/ .50" Flat Face Couplers and 90° fittings	121084	20

REPLACEMENT PARTS	ORDER CODE	SHIP WEIGHT (LBS)
Bucket Tooth - HL23 Series, Cast	88893	3.2
Flex Pin	88894	0.1

ROCK SAWS

ROCK SAW

ROCK SAWS



- Steel planetary drive delivers high torque
- Standard electro-hydraulic controls, depth controls, and side-shift
- Protective shields for hydraulic & electrical components
- Solid hardened steel wheels with greasable manifold pins and secluded greased zerks

Specifications

Model	Overall Width	Overall Length	Max Cut Depth	Wheel Dia.	Picks	Flow GPM	Weight w/o picks
RS18	67"	76"	18"	48"	42	22 to 44	1775 lbs
RS24	67"	86"	24"	60"	56	30 to 44	2095 lbs

ROCK SAW FOR SKID-STEER LOADERS



TO ORDER CHOOSE: ROCK SAW, HYDRAULIC MOTOR, PICK & HOLDERS, HYDRAULIC KIT AND CONTROLS

HIGH FLOW WITH HYDRAULIC SIDE SHIFT

	ORDER CODE	SHIP WEIGHT (LBS)
18" depth 22-44 GPM	106874	1775
24" depth minimum 30 GPM (24" requires a minimum of 2,500 lbs rated operating capacity)	106875	2095

HYDRAULIC MOTOR

	ORDER CODE	SHIP WEIGHT (LBS)
22 to 28 GPM hydraulic motor not compatible with 106875	17776	25
29 to 35 GPM hydraulic motor	17777	21
36 to 44 GPM hydraulic motor	17778	25

PICK & HOLDERS

	ORDER CODE	SHIP WEIGHT (LBS)
18" x 2.5" wide general purpose pick	106681	220
18" x 4.0" wide general purpose pick	106682	245
24" x 2.5" wide general purpose pick	106684	290
24" x 4.0" wide general purpose pick	106685	325

HYDRAULIC KIT

	ORDER CODE	SHIP WEIGHT (LBS)
88" hoses .50" flat face couplers	106876	28
106" hoses .50" flat face couplers	106877	32
88" hoses .625" flat face couplers	106878	28
106" hoses .625" flat face couplers	106879	32
88" hoses .75" flat face couplers	106880	28
106" hoses .75" flat face couplers	106881	32
Hose extension kit	119419	15

ROCK SAW CONTINUED NEXT PAGE

ROCK SAW

ROCK SAW FOR SKID-STEER LOADERS CONT.



HYDRAULIC CONTROL AND WIRE HARNESS OPTIONS (MUST CHOOSE ONE)	ORDER CODE	SHIP WEIGHT (LBS)
Control box w/ power lead	28-10754	5
Wire harness for CAT (14-pin "D" series)	07-8344	5
Wire harness for CAT pre-B (8-pin Deutsch)	07-10021	5
Wire harness for standard flow attachments on CAT B and C (8-pin Deutsch)	07-10122	5
Wire harness for John Deere-8 button (14-pin Deutsch)	LAF9361	5
Wire harness for John Deere EH control (14-pin Deutsch)	07-7626	5
Wire harness for John Deere (3-pin Deutsch)	07-7338	5
Wire harness for Komatsu (14-pin Deutsch)	07-10194	5
Wire harness for Komatsu (8-pin Deutsch)	07-10057	5
Wire Harness (multi function in cab controls) for CNH, JCB, Bobcat, Mustang, Kubota, Takeuchi, Volvo 14 Pin-8 Pin	LAF9360-0000	5
Wire harness for CNH (8-pin rectangular)	LAF9393	5

OPTIONAL - WATER KIT	ORDER CODE	SHIP WEIGHT (LBS)
Water nozzle kit for rock saw	112620	8
30gal Universal mount tank, 12v pump, with electrical control box	104444	65
30gal Universal mount tank, 12v pump, without electrical control box	105720	60

REPLACEMENT PARTS	ORDER CODE	SHIP WEIGHT (LBS)
Replacement Picks		
50 concrete picks	102059	30
50 general purpose picks	102058	30

SILAGE DEFACER

SILAGE DEFACER



- Designed to remove hay & corn silage from tightly compacted bunkers
- 96" cutting width to cut next to walls and straight through to back of bunker
- Adjustable guides for depth of cut
- 0 to 19 ft. working height

Specifications

Overall Length	Reach	Fixed Depth
8'	10'	0" to 3"

SILAGE DEFACER FOR SKID-STEER LOADERS



	ORDER CODE	SHIP WEIGHT (LBS)
silage defacer 18 to 22 GPM	16980	940
silage defacer short mount for skid steer loaders	103791	790

SILAGE DEFACER FOR EURO-GLOBAL MOUNTS



	ORDER CODE	SHIP WEIGHT (LBS)
silage defacer with euro / global mount	108343	870

SILAGE DEFACER FOR TELEHANDLERS



	ORDER CODE	SHIP WEIGHT (LBS)
Bobcat	12894	1130
Cat IT/TH	12425	1130
JCB Q-fit & New Holland Q-fit	12364	1130
K-D Manitou	12686	1130
JCB G Series (with serial #<0160037670)	13253	1130

SKID HOE/SWING HOE



- Fixed or swing configurations available
- Bucket curl feature
- 12", 16", 18" & 24" buckets available

Specifications					
Model	Weight (approx)	Width	Overall Reach	Digging Depth	Digging Force
111637 (fixed)	395 lbs	47.5"	75"	73"	3,895 lbs
112140 (swing)	535 lbs	47.5"	78"	76"	3,800 lbs



IMPORTANT: Some skid steer models require a tilt circuit hydraulic relief valve. This cartridge is **IN ADDITION TO THE EXISTING RELIEF CARTRIDGE** and is required to protect the circuit of the skid steer. Failure to install the cartridge when required can result in damage to the skid steer and will **VOID** all Bradco warranties. **CASE:** Models 1845C and XT units require no additional relief. **DEERE:** Models 4475, 5575, 6675, 7775 and 8875 require JD cartridge (JD part# MG86529091). Models 240, 250, 260, and 270 control valve **EXCEPT** for models with serial numbers greater than 440001 (JD240), 450001 (JD250), 460001 (JD260), 470001 (JD270) and 480001 (JD280), which require no additional relief. **BOBCAT:** Units with BICS do not require relief. Units without BICS but with a plug and relief on the tilt spool, require Bobcat part #6599161 to replace the plug. **GEHL:** Models 7600 and 7800 and **MUSTANG 2095 and 2105** install Gehl part #138703. **NEW HOLLAND:** Install relief cartridge (NH part #86529091).

SKID HOE/SWING HOE FOR SKID-STEER LOADERS



TO ORDER: CHOOSE ATTACHMENT AND BUCKET

FIXED SKID BACKHOE ASSEMBLY		ORDER CODE	SHIP WEIGHT (LBS)
skid hoe assembly (fixed)		111637	305
swing hoe		112140	550
BUCKETS (ONE REQUIRED)		ORDER CODE	SHIP WEIGHT (LBS)
Bucket Width			
12" standard (3 teeth)		81712	76
16" standard (4 teeth)		81716	89
18" standard (4 teeth)		81718	95
24" standard (5 teeth)		81724	115
OPTIONS		ORDER CODE	SHIP WEIGHT (LBS)
adjustable thumb kit (factory installed)		110680	67
adjustable thumb kit (dealer installed)		108571	67
In Cab Controls (required for control of swing hoe (second function))			
electrical control box required if skid steer is NOT equipped with attachment electrical controls		15756	10
14 pin Case, New Holland, Volvo, Ditch Witch		25887	5
3 pin John Deere		25885	5
14 pin John Deere Standard		25904	5
8 pin ASV, CAT, Komatsu		25886	5
14 pin Bobcat		110627	5

SNOW REMOVAL



SNOW REMOVAL

ICESHARK SNOW BLOWERS



- The new patented backdrag options allows operators to remove snow as close as 6" from a garage or wall to minimize the amount of shoveling required
- The built in yellow indicators guide users as they get close to a structure and give the operator guidance before engaging the backdrag functionality
- The new 3D floating hitch offers side to side, up and down, and front to back motion to allow the snow blower to have the smoothest operating experience when working on uneven surfaces
- The 3D floating hitch also allows for an uninterrupted scrape offering a cleaner surface which means less salt is required
- The dual articulating shoot offering unprecedented user control on where to place the snow with the 270 degrees of motion and ability to blow snow from as close as 3 feet or up to 45 feet
- The skid skis offer toolless adjustment which enable users to quickly and easily transition from gravel to pavement

SPECIFICATIONS	Compact & Standard Flow				High Flow	
	48"	60"	72"	84"	72"	84"
Overall Length without Backdrag	46"	46"	46"	46"	49.3"	49.3"
Overall Length with Backdrag*	-	57.8"	57.8"	57.8"	61.3"	61.3"
Overall Width	53"	65"	77"	89"	77"	89"
Maximum Overall Height	71"	71"	71"	71"	78"	78"
Minimum Overall Height	60"	60"	60"	60"	65.75"	65.75"
Cutting Width	48"	60"	72"	84"	72"	84"
Cutting Height	27.5"	27.5"	27.5"	27.5"	34"	34"
Hydraulic Pressure	3500 PSI				4200 PSI	

*Backdrag not available in 48" models

SNOW BLOWERS FOR SKID-STEER LOADERS



SNOW BLOWER	ORDER CODE	SHIP WEIGHT (LBS)
CHECK LOADER CAPACITY BEFORE ORDERING		
CONTROL BOX/HARNESS NOT INCLUDED - MUST ORDER SEPARATELY		
Compact Flow		
48" Compact-Flow Snow Blower w/ GPM Range 8-15, No Backdrag	25048B-0022	820
Standard Flow		
60" Standard-Flow Snow Blower w/GPM Range 15-27, No Backdrag	25060D-0022	860
60" Standard-Flow Snow Blower w/GPM Range 15-27, Backdrag Included	25060DBD-0022	1020
72" Standard-Flow Snow Blower w/GPM Range 15-27, No Backdrag	25072D-0022	905
72" Standard-Flow Snow Blower w/GPM Range 15-27, Backdrag Included	25072DBD-0022	1070
84" Standard-Flow Snow Blower w/GPM Range 15-27, No Backdrag	25084D-0022	945
84" Standard-Flow Snow Blower w/GPM Range 15-27, Backdrag Included	25084DBD-0022	1120

SNOW BLOWERS CONTINUED NEXT PAGE

ICESHARK SNOW BLOWERS

SNOW BLOWERS FOR SKID-STEER LOADERS CONT.

SNOW BLOWER CONT.	ORDER CODE	SHIP WEIGHT (LBS)
High-Flow Snow Blower		
72" High-Flow Snow Blower w/GPM Range 27-35, No Backdrag	25072F-0022	1030
72" High-Flow Snow Blower w/GPM Range 27-35, Backdrag Included	25072FBD-0022	1200
84" High-Flow Snow Blower w/GPM Range 27-35, No Backdrag	25084F-0022	1080
84" High-Flow Snow Blower w/GPM Range 27-35, Backdrag Included	25084FBD-0022	1260
Extra High-Flow Snow Blower		
72" Extra High-Flow Snow Blower w/GPM Range 35-45, No Backdrag	25072H-0022	1045
72" Extra High-Flow Snow Blower w/GPM Range 35-45, Backdrag Included	25072HBD-0022	1220
84" Extra High-Flow Snow Blower w/GPM Range 35-45, No Backdrag	25084H-0022	1090
84" Extra High-Flow Snow Blower w/GPM Range 35-45, Backdrag Included	25084HBD-0022	1280
HYDRAULIC CONTROL AND WIRE HARNESS OPTIONS (MUST CHOOSE ONE)		
Standard Control Box - 3-function in 2 direction (3 switch)	07-10013	1
Control box with power lead - 2-function in 2 direction (2 switch)	LAF9394-0000	5
Wire harness for CAT pre-B (8-pin Deutsch)	07-10021	5
Wire harness for standard flow attachments on CAT B and C (8-pin Deutsch)	07-10122	5
Control box with wire harness for high flow attachments on CAT B and C (8-pin Deutsch)	07-10170	5
Wire harness for selectable joystick controls (7-pin for Bobcat)	07-9548	1
Wire harness for CAT (14-pin "D" series)	07-8344	1
Wire Harness (multi function in cab controls) for CNH, JCB, Bobcat, Mustang, Kubota, Takeuchi, Volvo 14 Pin-8 Pin	LAF9360-0000	5
Wire harness for CNH (8-pin rectangular)	LAF9393	5
Wire harness for John Deere (3-pin Deutsch)	07-7338	5
Wire harness for John Deere EH control (14-pin Deutsch)	07-7626	5
Wire harness for Komatsu (14-pin Deutsch)	07-10194	5
Wire harness for Komatsu (8-pin Deutsch)	07-10057	5
REPLACEMENT PARTS (INCLUDE HARDWARE)		
48" Steel Edge Kit	28-11300-48	
60" Steel Edge Kit	28-1130-60	
72" Steel Edge Kit	28-11300-72	
84" Steel Edge Kit	28-11300-84	
48" Polyurethane Edge Kit	28-11301-48	
60" Polyurethane Edge Kit	28-11301-60	
72" Polyurethane Edge Kit	28-11301-72	
84" Polyurethane Edge Kit	28-11301-84	
Steel Wear Shoe Kit	28-11312	
Soft Wear Shoe Kit	28-11313	
Kit Service Supply/Return Hoses/Ftgs HF/XHF	28-11341	
Kit Service Supply/Return Hoses/Ftgs SF/LF	28-11342	
Kit Service QD 1/2" ISO 16028 (1 M & 1 F)	28-9570	
Kit Service Chute Rotation Motor	28-11302	
Kit Service Impeller LF Motor (Motor & Hardware)	28-11305	
Kit Service Impeller SF Motor (Motor & Hardware)	28-11306	
Kit Service Impeller HF Motor (Motor & Hardware)	28-11303	
Kit Service Impeller XHF Motor (Motor & Hardware)	28-11304	
Kit Service Auger LF Motor (Motor & Hardware)	28-11308	
Kit Service Auger SF Motor (Motor & Hardware)	28-11309	
Kit Service Auger XHF/HF Motor (Motor & Hardware)	28-11307	
Kit Seal Impeller/Auger Motor (Motor & Hardware)	LAF4572-0000	

SNOW BLOWER OPTIONS CONTINUED NEXT PAGE

SNOW REMOVAL

ICESHARK SNOW BLOWERS

SNOW BLOWERS FOR SKID-STEER LOADERS CONT.

OPTIONS	ORDER CODE	SHIP WEIGHT (LBS)
Backdrag Kit, 60" Standard-Flow	28-11225-60	
Backdrag Kit, 72" Standard-Flow	28-11225-72	
Backdrag Kit, 84" Standard-Flow	28-11225-84	
Backdrag Kit, 72" High-Flow, Extra High-Flow	28-11219-72	
Backdrag Kit, 84" High-Flow, Extra High-Flow	28-11219-84	

EXTENDED HOSE KITS (FOR JCB AND VOLVO SKID STEERS)	ORDER CODE	SHIP WEIGHT (LBS)
20" SF Extended Hose Kits	28-11367	
30" HF Extended Hose Kits	28-11368	

SNOW BLADES

114 SERIES SNOW BLADES



- Hydraulically or manually angles 30° in either direction
- Reversible, replaceable wear edge, optional rubber edge
- Adjustable skid shoes
- Spring-loaded trip mechanism
- 7-gauge steel blade

Carrier Specifications		Specifications				
Lift Capacity	Operating Weight	Model	Weight (approx)	Width OD	Height OD	Cutting Width @ Max Angle
<5,000 lbs.	<8,000 lbs.	11460	510 lbs	60"	23"	52"
		11472	595 lbs	72"	23"	62"
		11484	635 lbs	84"	23"	73"
		11496	650 lbs	96"	23"	83"



IMPORTANT: The LAF114 Series Snow Blade is for all skid steer and utility loader models up to 80 hp. Locking bolts (part # RHW8063-0000) are included for light dirt-moving for skid steers only. All replacement hydraulic hoses and fittings must have a minimum rated working pressure of 4000 psi.

SNOW BLADES CONTINUED NEXT PAGE

SNOW BLADES CONT.

114 SERIES SNOW BLADES CONT.



INCLUDES: STEEL SNOW BLADE, UNIVERSAL SSL MOUNTING, HOSES AND COUPLERS
TO ORDER: CHOOSE SNOW BLADE AND MOUNT, DENOTE DESIRED ANGLE TYPE WHEN ORDERING

SNOW BLADE CHECK LOADER CAPACITY BEFORE ORDERING	ORDER CODE	SHIP WEIGHT (LBS)
114 Series - Manual Angle		
60" manual angle snow blade	11460M-0022	510
72" manual angle snow blade	11472M-0022	595
84" manual angle snow blade	11484M-0022	635
96" manual angle snow blade	11496M-0022	650
114 Series - Hydraulic Angle		
60" hydraulic angle snow blade	11460-0022	510
72" hydraulic angle snow blade	11472-0022	595
84" hydraulic angle snow blade	11484-0022	635
96" hydraulic angle snow blade	11496-0022	650

MOUNTING - ADDITIONAL COST MAY APPLY	ORDER CODE	SHIP WEIGHT (LBS)
Contact Customer Service at (833) 723-1843		
114 SERIES SNOW BLADES CONTINUED NEXT PAGE		

OPTIONS - REPLACEMENT PARTS	ORDER CODE	SHIP WEIGHT (LBS)
Replacement edges - Steel and Rubber with hardware		
Optional Rubber Edge Kit		
rubber edge for 11460 snow blade	LAF6485-0000	43
rubber edge for 11472 snow blade	LAF6486-0000	52
rubber edge for 11484 snow blade	LAF6487-0000	59
rubber edge for 11496 snow blade	LAF6488-0000	67
Replaceable Steel Edge Kit		
steel edge for 11460 snow blade	FFC10105	32
steel edge for 11472 snow blade	FFC10106	39
steel edge for 11484 snow blade	FFC10107	45
steel edge for 11496 snow blade	FFC10108	51
Angle Kits		
manual angle kit for snow blade 1400 series	FFC10014	10
hydraulic angle kit for snow blade 1400 series	FFC10049	18

SNOW REMOVAL

SNOW BLADES

115 SERIES SNOW BLADES



- Hydraulically angles 35° in either direction
- Replaceable bolt-on wear edge.
- Optional rubber edge
- Skid shoes with adjustable height
- Reinforced 7-gauge steel blade
- Spring-loaded trip mechanism

Carrier Specifications	
Lift Capacity	Operating Weight
<10,000 lbs.	<20,000 lbs.

Specifications				
Model	Weight (approx)	Width	Height	Cutting Width @ 35° Angle
11584	1125 lbs	84"	32"	69"
11596	1180 lbs	96"	32"	79"
11508	1235 lbs	108"	32"	88"
11520	1315 lbs	120"	32"	98"
11532	1375 lbs	132"	32"	108"
11544	1435 lbs	144"	32"	118"

! **IMPORTANT:** Check capacity and limits of skid steer or loader before ordering. Add 1 foot to the carrier width when sizing a blade. All replacement hydraulic hoses and fittings must have a minimum rated working pressure of 4000 psi.

115 SERIES SNOW BLADES FOR SKID-STEER LOADERS AND TRACTOR LOADERS/BACKHOES



i **INCLUDES: STEEL SNOW BLADE AND UNIVERSAL SSL MOUNTING. HOSES AND COUPLERS INCLUDED FOR SKID-STEER LOADERS ONLY. TO ORDER: CHOOSE SNOW BLADE AND MOUNT, DENOTE DESIRED ANGLE TYPE WHEN ORDERING**

SNOW BLADE CHECK LOADER CAPACITY BEFORE ORDERING	ORDER CODE	SHIP WEIGHT (LBS)
84" snow blade	11584-0022	1186
96" snow blade	11596-0022	1232
108" snow blade	11508-0022	1309
120" snow blade	11520-0022	1393
132" snow blade	11532-0022	1473
144" snow blade	11544-0022	1558

MOUNTING - ADDITIONAL COST MAY APPLY	ORDER CODE	SHIP WEIGHT (LBS)
Contact Customer Service at (833) 723-1843		

Standardized mounting with the exception of ACS, CAT Fusion and Bobcat X-Change

OPTIONS - REPLACEMENT PARTS	ORDER CODE	SHIP WEIGHT (LBS)
Marker Kit	11601	5

115 SERIES SNOW BLADES CONTINUED NEXT PAGE

SNOW BLADES CONT.

115 SERIES SNOW BLADES CONT.

Replacement edges - Steel and Rubber with hardware		
Optional Rubber Edge Kit		
rubber edge for 11584 snow blade	LAF1551-0000	123
rubber edge for 11596 snow blade	LAF1552-0000	134
rubber edge for 11508 snow blade	LAF1553-0000	145
rubber edge for 11520 snow blade	LAF1554-0000	155
rubber edge for 11532 snow blade	LAF1555-0000	166
rubber edge for 11544 snow blade	LAF1556-0000	176
Replaceable Steel Edge Kit		
steel edge for 11584 snow bade	10117	160
steel edge for 11596 snow blade	10118	176
steel edge for 11508 snow blade	10119	192
steel edge for 11520 snow blade	10120	207
steel edge for 11532 snow blade	10121	223
steel edge for 11544 snow blade	10122	239
Polyurethane Edge Kit		
polyurethane edge for 11584 snow bade	28-10755-84	60
polyurethane edge for 11596 snow blade	28-10755-96	65
polyurethane edge for 11508 snow blade	28-10755-108	70
polyurethane edge for 11520 snow blade	28-10755-120	75
polyurethane edge for 11532 snow blade	28-10755-132	80
polyurethane edge for 11544 snow blade	28-10755-144	85
Top Flap - Reduces Snow Spillage		
top flap for 11584 snow blade	LAF6492-0000	62
top flap for 11596 snow blade	LAF6493-0000	64
top flap for 11508 snow blade	LAF6494-0000	66
top flap for 11520 snow blade	LAF6495-0000	68
top flap for 11532 snow blade	LAF6497-0000	70
top flap for 11544 snow blade	LAF6498-0000	72
Hydraulic Cushion Kit - Protects damage to cylinders		
hydraulic cushion kit <i>(Included on ALL newly purchased models 120" wide and larger)</i>	28-10447	10

SNOW REMOVAL

SNOW BLADES

5700 SERIES SNOW BLADES



- Hydraulically angles 30° in either direction
- Replaceable bolt-on wear edge. Optional rubber edge
- Skid shoes with adjustable height
- Reinforced 7-gauge steel blade
- Spring-loaded trip mechanism

Carrier Specifications	
Lift Capacity	Operating Weight
<9,000 lbs.	<11,000 lbs.

Specifications				
Model	Weight (approx)	Width	Height	Cutting Width @ 30° Angle
LAF5784	875 lbs	84"	32"	73"
LAF5796	930 lbs	96"	32"	83"
LAF5708	890 lbs	108"	32"	93"
LAF5720	1065 lbs	120"	32"	104"
LAF5744	1185 lbs	144"	32"	125"

! **IMPORTANT: All replacement hydraulic hoses and fittings must have a minimum rated working pressure of 4000 psi.**

5700 SERIES SNOW BLADES FOR SKID-STEER LOADERS AND TRACTOR LOADERS/BACKHOES



i **INCLUDES: SNOW BLADE AND UNIVERSAL SSL MOUNTING. HOSES AND COUPLERS INCLUDED FOR SKID-STEERS ONLY. TO ORDER: CHOOSE SNOW BLADE AND MOUNT**

SNOW BLADE CHECK LOADER CAPACITY BEFORE ORDERING	ORDER CODE	SHIP WEIGHT (LBS)
84" Snow Blade	LAF5784-0022	935
96" Snow Blade	LAF5796-0022	995
108" Snow Blade	LAF5708-0022	1060
120" Snow Blade includes Hydraulic Cushion Kit required on plows 120" and larger	LAF5720-0022	1140
144" Snow Blade includes Hydraulic Cushion Kit required on plows 120" and larger	LAF5744-0022	1275

MOUNTING - ADDITIONAL COST MAY APPLY	ORDER CODE	SHIP WEIGHT (LBS)
Contact Customer Service at (833) 723-1843		
115 SERIES SNOW BLADES CONTINUED NEXT PAGE		

SNOW BLADES

5700 SERIES SNOW BLADES CONT.

OPTIONS - REPLACEMENT PARTS	ORDER CODE	SHIP WEIGHT (LBS)
Replacement edges - Steel and Rubber with hardware		
Optional Rubber edge Kit		
rubber edge for LAF5784 snow blade	LAF1551-0000	123
rubber edge for LAF5796 snow blade	LAF1552-0000	134
rubber edge for LAF5708 snow blade	LAF1553-0000	145
rubber edge for LAF5720 snow blade	LAF1554-0000	155
rubber edge for LAF5744 snow blade	LAF1556-0000	176
Replacement edges - Steel and Rubber with hardware		
Replaceable steel edge Kit		
steel edge for LAF5784 snow blade	10117	160
steel edge for LAF5796 snow blade	10118	176
steel edge for LAF5708 snow blade	10119	196
steel edge for LAF5720 snow blade	10120	207
steel edge for LAF5744 snow blade	10122	239
Polyurethane Edge Kit		
polyurethane edge for LAF5784 snow bade	28-10755-84	60
polyurethane edge for LAF5796 snow blade	28-10755-96	65
polyurethane edge for LAF5708 snow blade	28-10755-108	70
polyurethane edge for LAF5720 snow blade	28-10755-120	75
polyurethane edge for LAF5744 snow blade	28-10755-144	85
Top Flap (reduces snow spillage)		
top flap for LAF5784 snow blade	LAF6492-0000	62
top flap for LAF5796 snow blade	LAF6493-0000	64
top flap for LAF5708 snow blade	LAF6494-0000	66
top flap for LAF5720 snow blade	LAF6495-0000	68
top flap for LAF5744 snow blade	LAF6498-0000	72
Hydraulic Cushion Kit (protects damage to cylinders)		
Hydraulic Cushion Kit (Included on ALL newly purchased models 120" wide and greater)	28-10446	10

SNOW REMOVAL

SNOW BLADES

120 SERIES V-BLADE



- Available in seven blade widths
- Available with hydraulic sequencing valve or electro-hydraulic valve for independent blade function
- Adjustable Blade allows for straight, V or scoop positions
- Angles up to 30° in both directions
- Reversible cutting edge designed with spring loaded trip mechanism
- Blade floats 5° and tilts 5° for ground contour

Specifications

Model	Weight (Approx)	Height	Width (Straight)	Cutting Width at Full "V"	Cutting Width at Full "Scoop"	Cutting Width at Max Angle (30°)
12050	830 lbs	32.5"	48"	45.5"	37.5"	41.5"
12060	865 lbs	32.5"	60"	56"	48"	52"
12072	920 lbs	32.5"	72"	66.5"	58.5"	62.5"
12084	975 lbs	32.5"	84"	77"	69"	73"
12096	1020 lbs	32.5"	96"	87.5"	79.5"	83.5"
12008	1060 lbs	32.5"	108"	98"	90"	94"
12020	1110 lbs	32.5"	120"	108"	100.5"	104"



IMPORTANT: Check capacity and limits of carrier before ordering. Add 1 foot to the carrier width when sizing a blade. All replacement hydraulic hoses and fittings must have a minimum rated working pressure of 4000 psi.

120 SERIES V-BLADE FOR SKID-STEER LOADERS AND COMPACT WHEEL LOADERS



PRICE INCLUDES: STEEL SNOW BLADE AND UNIVERSAL SSL MOUNTING. HOSES & COUPLERS INCLUDED FOR SKID-STEERS ONLY. TO ORDER: CHOOSE SNOW BLADE, MOUNT AND HYDRAULIC CONTROL

SNOW BLADE CHECK LOADER CAPACITY BEFORE ORDERING	ORDER CODE	SHIP WEIGHT (LBS)
48" V-Snow Blade, hydraulic only controls	12050-0022	830
60" V-Snow Blade, hydraulic only controls	12060-0022	925
72" V-Snow Blade, hydraulic only controls	12072-0022	980
84" V-Snow Blade, hydraulic only controls	12084-0022	1040
96" V-Snow Blade, hydraulic only controls	12096-0022	1090
108" V-Snow Blade, hydraulic only controls	12008-0022	1145
120" V-Snow Blade, hydraulic only controls	12020-0022	1190
48" V-Snow Blade, hydraulic/electric controls	12050E-0022	830
60" V-Snow Blade, hydraulic/electric controls	12060E-0022	925
72" V-Snow Blade, hydraulic/electric controls	12072E-0022	980
84" V-Snow Blade, hydraulic/electric controls	12084E-0022	1040
96" V-Snow Blade, hydraulic/electric controls	12096E-0022	1090
108" V-Snow Blade, hydraulic/electric controls	12008E-0022	1145
120" V-Snow Blade, hydraulic/electric controls	12020E-0022	1190

120 SERIES V-BLADE CONTINUED NEXT PAGE

SNOW BLADES

120 SERIES V-BLADE CONT.

HYDRAULIC CONTROL AND WIRE HARNESS OPTIONS (MUST CHOOSE ONE)	ORDER CODE	SHIP WEIGHT (LBS)
Control box with power lead - 2-function in 2 direction (2 switch)	LAF9394-0000	5
Wire harness for CAT pre-B (8-pin Deutsch)	07-10021	5
Wire harness for standard flow attachments on CAT B and C (8-pin Deutsch)	07-10122	5
Control box with wire harness for high flow attachments on CAT B and C (8-pin Deutsch)	07-10170	5
Wire harness for selectable joystick controls (7-pin for Bobcat)	07-9548	1
Wire harness for CAT (14-pin "D" series)	07-8344	1
Wire Harness (multi function in cab controls) for CNH, JCB, Bobcat, Mustang, Kubota, Takeuchi, Volvo 14 Pin-8 Pin	LAF9360-0000	5
Wire harness for CNH (8-pin rectangular)	LAF9393	5
Wire harness for John Deere (3-pin Deutsch)	07-7338	5
Wire harness for John Deere EH control (14-pin Deutsch)	07-7626	5
Wire harness for John Deere P-Tier EH control (14-pin Deutsch)	07-9617	5
Wire harness for Komatsu (14-pin Deutsch)	07-10194	5
Wire harness for Komatsu (8-pin Deutsch)	07-10057	5

OPTIONS - REPLACEMENT PARTS	ORDER CODE	SHIP WEIGHT (LBS)
Optional Polyurethane Edge Kit		
polyurethane edge Kit for 12050 & 12050E V-Blade	28-10646-50	70
polyurethane edge Kit for 12060 & 12060E V-Blade	28-10646-60	75
polyurethane edge Kit for 12072 & 12072E V-Blade	28-10646-72	80
polyurethane edge Kit for 12084 & 12084E V-Blade	28-10646-84	85
polyurethane edge Kit for 12096 & 12096E V-Blade	28-10646-96	90
polyurethane edge Kit for 12008 & 12008E V-Blade	28-10646-108	95
polyurethane edge Kit for 12020 & 12020E V-Blade	28-10646-120	100

Deflector Kit - Reduces Snow Spillage		
deflector kit for 12050 & 12050E V-Blade	28-10717-50	35
deflector kit for 12060 & 12060E V-Blade	28-10717-60	40
deflector kit for 12072 & 12072E V-Blade	28-10717-72	45
deflector kit for 12084 & 12084E V-Blade	28-10717-84	50
deflector kit for 12096 & 12096E V-Blade	28-10717-96	55
deflector kit for 12008 & 12008E V-Blade	28-10717-108	60
deflector kit for 12020 & 12020E V-Blade	28-10717-120	65

Replacement Steel Edge Kit		
steel edge Kit for 12050 & 12050E V-Blade	28-10645-50	95
steel edge Kit for 12060 & 12060E V-Blade	28-10645-60	105
steel edge Kit for 12072 & 12072E V-Blade	28-10645-72	115
steel edge Kit for 12084 & 12084E V-Blade	28-10645-84	125
steel edge Kit for 12096 & 12096E V-Blade	28-10645-96	135
steel edge Kit for 12008 & 12008E V-Blade	28-10645-108	145
steel edge Kit for 12020 & 12020E V-Blade	28-10645-120	155
Marker Kit	11601	5

Hydraulic Only Control to Hydraulic/Electric Conversion Kit		
Conversion Kit	28-10705	20

SNOW REMOVAL

SNOW BUCKETS



- Moves large volumes of snow or other loose materials efficiently
- Cut out back plate for better visibility
- Quickly attaches to all skid-steer, backhoe, utility loader and small wheel loader brands
- Optional bolt-on edge available

Carrier Specifications	
Medium Duty Bucket	
Lift Capacity	Operating Weight
<5,000 lbs.	<8,000 lbs.

Heavy Duty Bucket	
Lift Capacity	Operating Weight
<9,500 lbs.	<11,000 lbs.

Specifications							
Model	Weight Approx	Width	Height	Depth	Leading Edge	Capacity Struck	Capacity Heaped
11184	733 lbs	84"	29.9"	42.0"	29.7"	1.14 yd ³	1.47 yd ³
11196	795 lbs	96"	29.9"	42.0"	29.7"	1.31 yd ³	1.70 yd ³
11197	999 lbs	96"	37.6"	46.2"	32.5"	1.83 yd ³	2.36 yd ³
11101	820 lbs	101.5"	29.9"	42.0"	29.7"	1.40 yd ³	1.82 yd ³
11102	1020 lbs	101.5"	37.6"	46.2"	32.5"	1.95 yd ³	2.52 yd ³
11108	1078 lbs	108"	37.6"	46.2"	32.5"	2.07 yd ³	2.67 yd ³

SNOW BUCKETS FOR SKID-STEER LOADERS



INCLUDES: SNOW BUCKET, BOLT ON EDGE, AND UNIVERSAL SSL MOUNTING
TO ORDER: CHOOSE SNOW BUCKET AND MOUNT

SNOW BUCKET	ORDER CODE	SHIP WEIGHT (LBS)
CHECK LOADER CAPACITY BEFORE ORDERING		
Medium-Duty Snow Bucket		
84" OD Medium-Duty Snow Bucket (BOE Included)	11184-0022	733
96" OD Medium-Duty Snow Bucket (BOE Included)	11196-0022	795
101" OD Medium-Duty Snow Bucket (BOE Included)	11101-0022	820
Heavy-Duty Snow Bucket		
96" OD Heavy-Duty Snow Bucket (BOE Included)	11197-0022	999
101" OD Heavy-Duty Snow Bucket (BOE Included)	11102-0022	1020
108" OD Heavy-Duty Snow Bucket (BOE Included)	11108-0022	1078
MOUNTING - ADDITIONAL COST MAY APPLY		
Contact Customer Service at (833) 723-1843		

OPTIONS - REVERSIBLE CUTTING EDGE KIT	OPTIONAL BOLT ON EDGE	SHIP WEIGHT (LBS)
Includes BOE, grade 8 plow bolts, lock washers & nuts Drilled for FFC bolt-on edge (Holes spaced 6" apart, center to center)		
For Bucket 11184-0022 (9 holes, 9.75" spacing)	16183	203
For Bucket 11196-0022 (16 holes, 6" spacing)	FFC10084	232
For Bucket 11197-0022 (16 holes, 6" spacing)	FFC10084	232
For Bucket 11101-0022 (17 holes, 6" spacing)	118960	247
For Bucket 11102-0022 (17 holes, 6" spacing)	118960	247
For Bucket 11108-0022 (18 holes, 6" spacing)	10094	254

SNOW PUSH

228 SERIES SNOW PUSH (4 FT X 4 FT)

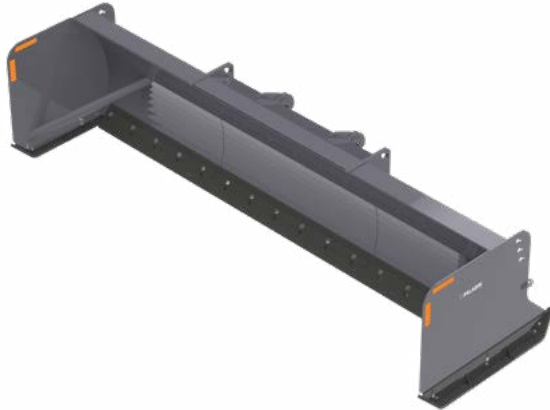

- Moves large volumes of snow efficiently. Also ideal for waste water, manure, feed lot and flood cleanup
- Optional pull back kit draws back snow from buildings, fences and confined areas
- Optional bucket lip mount available for 12' and 14' models

Carrier Specifications	
Lift Capacity	Operating Weight
<11,000 lbs.	<32,000 lbs.

228 Series (4 ft x 4 ft) Snow Push Specifications					
Model	Path Width	Working Height	Depth	Overall Width	Weight (approx)
22812	142.5"	48.8"	71.8"	149.7"	2485
22814	166.5"	48.8"	71.8"	173.7"	2660
22816	190.5"	48.8"	71.8"	197.7"	2835
22820	238.5"	48.8"	71.8"	245.7"	3185

228 SERIES SNOW PUSH (4 FT X 4 FT) FOR TRACTOR LOADERS/BACKHOES, UTILITY TRACTORS AND WHEEL LOADERS



INCLUDES: SNOW PUSH, RUBBER EDGE AND HEAVY DUTY SNOW SHOES. EXCLUDES MOUNTING CHARGES. TO ORDER: CHOOSE SNOW PUSH AND MOUNT

SNOW PUSH	ORDER CODE	SHIP WEIGHT (LBS)
12 ft 228 Series 4x4 Snow Push, Bucket Lip Mount	22812-0057	2485
12 ft 228 Series 4x4 Snow Push, JRB 416 Mount	22812-0913	2485
12 ft 228 Series 4x4 Snow Push, Volvo QA	22812-0934	2485
14 ft 228 Series 4x4 Snow Push, Bucket Lip Mount	22814-0057	2660
14 ft 228 Series 4x4 Snow Push, JRB 416 Mount	22814-0913	2660
14 ft 228 Series 4x4 Snow Push, Volvo QA	22814-0934	2660
16 ft 228 Series 4x4 Snow Push, Bucket Lip Mount	22816-0057	2835
16 ft 228 Series 4x4 Snow Push, JRB 416 Mount	22816-0913	2835
16 ft 228 Series 4x4 Snow Push, Volvo QA	22816-0934	2835
20 ft 228 Series 4x4 Snow Push, Bucket Lip Mount	22820-0057	3185
20 ft 228 Series 4x4 Snow Push, JRB 416 Mount	22820-0913	3185
20 ft 228 Series 4x4 Snow Push, Volvo QA	22820-0934	3185
MOUNTING	ORDER CODE	SHIP WEIGHT (LBS)
Contact Customer Service at (833) 723-1843 for pricing and availability of alternative mounts.		
OPTIONS	ORDER CODE	SHIP WEIGHT (LBS)
Chain & Binder Kit	28-9213	N/A

SNOW REMOVAL

SNOW PUSH

228 SERIES SNOW PUSH (4 FT X 4 FT) FOR TRACTOR LOADERS/BACKHOES, UTILITY TRACTORS AND WHEEL LOADERS CONT.

REPLACEMENT PARTS	ORDER CODE	SHIP WEIGHT (LBS)
Rubber Edge Kits for Snow Push (Includes Hardware and Retaining Plates)		
Rubber Edge Kit for 12' Snow Push	28-10842-12	170
Rubber Edge Kit for 14' Snow Push	28-10842-14	190
Rubber Edge Kit for 16' Snow Push	28-10842-16	210
Rubber Edge Kit for 20' Snow Push	28-10842-20	260
Snow Shoe		
Snow Shoe (1 shoe)	13-17627	130

232 SERIES SNOW PUSH - LOW PROFILE



- Moves large volumes of snow efficiently. Also ideal for waste water, manure, feed lot and flood cleanup
- Optional pull back kit draws back snow from buildings, fences and confined areas

Carrier Specifications	
Lift Capacity	Operating Weight
<9,500 lbs.	<11,500 lbs.

Specifications					
Model	Path Width	Working Height	Depth	Overall Width	Weight (approx)
23272-0022	71.5"	23.7"	38.1"	77.3"	525 lbs
23284-0022	83.5"	23.7"	38.1"	89.3"	570 lbs
23296-0022	95.5"	23.7"	38.1"	101.3"	610 lbs
23220-0022	119.5"	23.7"	38.1"	125.3"	705 lbs

232 SERIES SNOW PUSH - LOW PROFILE FOR SKID-STEER LOADERS



INCLUDES: SNOW PUSH, RUBBER EDGE, STANDARD SNOW SHOES, RUBBER EDGE AND UNIVERSAL SSL MOUNTING. OPTIONAL HEAVY DUTY SNOW SHOES AVAILABLE TO ORDER: CHOOSE SNOW PUSH AND MOUNT

SNOW PUSH	ORDER CODE	SHIP WEIGHT (LBS)
6' 232 Series Low Profile Snow Push	23272	605
7' 232 Series Low Profile Snow Push	23284	670
8' 232 Series Low Profile Snow Push	23296	735
10' 232 Series Low Profile Snow Push	23220	865

MOUNTING	ORDER CODE	SHIP WEIGHT (LBS)
Universal SSL Mount	0022	N/A

SNOW PUSH

232 SERIES SNOW PUSH - LOW PROFILE CONT.

OPTIONS	ORDER CODE	SHIP WEIGHT (LBS)
Pull Back Kit Without Rubber Edge		
Factory Installed (ordered with Snow Push) Add weight to ordered Snow Push		
6' Pull Back Kit w/out Rubber Edge	28-10751-72	155
7' Pull Back Kit w/out Rubber Edge	28-10751-84	175
8' Pull Back Kit w/out Rubber Edge	28-10751-96	200
10' Pull Back Kit w/out Rubber Edge	28-10751-120	250
Field Installed (After Market Kit)		
6' Pull Back Kit w/out Rubber Edge	28-10837-72	200
7' Pull Back Kit w/out Rubber Edge	28-10837-84	235
8' Pull Back Kit w/out Rubber Edge	28-10837-96	270
10' Pull Back Kit w/out Rubber Edge	28-10837-120	330
Pull Back Kit With Rubber Edge		
Factory Installed (ordered with Snow Push) Add weight to ordered Snow Push		
6' Pull Back Kit with Rubber Edge	28-10753-72	185
7' Pull Back Kit with Rubber Edge	28-10753-84	215
8' Pull Back Kit with Rubber Edge	28-10753-96	245
10' Pull Back Kit with Rubber Edge	28-10753-120	300
Field Installed (After Market Kit)		
6' Pull Back Kit with Rubber Edge	28-10838-72	235
7' Pull Back Kit with Rubber Edge	28-10838-84	275
8' Pull Back Kit with Rubber Edge	28-10838-96	315
10' Pull Back Kit with Rubber Edge	28-10838-120	380
REPLACEMENT PARTS		
Rubber Edge Kits (Includes Hardware and Retaining Plates)		
6' Rubber Edge Kit for Snow Push or Pullback Kit	28-10840-72	70
7' Rubber Edge Kit for Snow Push or Pullback Kit	28-10840-84	80
8' Rubber Edge Kit for Snow Push or Pullback Kit	28-10840-96	90
10' Rubber Edge Kit for Snow Push or Pullback Kit	28-10840-120	110
Snow Shoes		
Standard Duty Snow Shoe (1 shoe)	LAF3605-0000	50
Heavy Duty Snow Shoe (1 shoe)	13-18356	60

SNOW REMOVAL

SNOW PUSH

233 SERIES SNOW PUSH (3 FT X 3 FT)



- Moves large volumes of snow efficiently. Also ideal for waste water, manure, feed lot and flood cleanup
- Optional pull back kit draws back snow from buildings, fences and confined areas
- Optional bucket lip mount available for 10', 12' and 14' models

Carrier Specifications	
Lift Capacity	Operating Weight
<11,000 lbs.	<20,000 lbs.

233 Series (3ft x 3ft) Snow Push Specifications					
Model	Path Width	Working Height	Depth	Overall Width	Weight (approx)
23396	95.5"	41.3"	41.5"	101.5"	1100 lbs
23320	119.5"	41.3"	41.5"	125.5"	1230 lbs
23344	143.5"	41.3"	41.5"	149.5"	1375 lbs
23368	167.5"	41.3"	41.5"	173.5"	1505 lbs

233 SERIES SNOW PUSH (3 FT X 3 FT) FOR SKID-STEER LOADERS, TRACTOR LOADERS/BACKHOES, UTILITY TRACTORS AND WHEEL LOADERS



INCLUDES: SNOW PUSH, RUBBER EDGE, STANDARD SNOW SHOES, RUBBER EDGE AND UNIVERSAL SSL MOUNTING. OPTIONAL HEAVY DUTY SNOW SHOES AVAILABLE TO ORDER: CHOOSE SNOW PUSH AND MOUNT

SNOW PUSH	ORDER CODE	SHIP WEIGHT (LBS)
8' 233 Series 3x3 Snow Push	23396	1,220
10' 233 Series 3x3 Snow Push	23320	1,390
12' 233 Series 3x3 Snow Push	23344	1,575
14' 233 Series 3x3 Snow Push	23368	1,745

MOUNTING	ORDER CODE	SHIP WEIGHT (LBS)
Universal SSL Mount	0022	N/A

Standardized mounting with the exception of ACS, CAT Fusion and Bobcat X-Change

Contact Customer Service at (833) 723-1843 for pricing and availability of alternative mounts.

OPTIONS	ORDER CODE	SHIP WEIGHT (LBS)
Pull Back Kit Without Rubber Edge		
Factory Installed (ordered with Snow Push) Add weight to ordered Snow Push		
8' Pull Back Kit w/out Rubber Edge	28-10751-96	200
10' Pull Back Kit w/out Rubber Edge	28-10751-120	250
12" Pull Back Kit w/out Rubber Edge	28-10751-144	290
14" Pull Back Kit w/out Rubber Edge	28-10751-168	335

233 SERIES CONTINUED NEXT PAGE

SNOW PUSH

233 SERIES SNOW PUSH (3 FT X 3 FT) FOR SKID-STEER LOADERS, TRACTOR LOADERS/BACKHOES, UTILITY TRACTORS AND WHEEL LOADERS CONT.

OPTIONS	ORDER CODE	SHIP WEIGHT (LBS)
Pull Back Kit Without Rubber Edge		
Field Installed (After Market Kit)		
8' Pull Back Kit w/out Rubber Edge	28-10837-96	270
10' Pull Back Kit w/out Rubber Edge	28-10837-120	330
12' Pull Back Kit w/out Rubber Edge	28-10837-144	380
14' Pull Back Kit w/out Rubber Edge	28-10837-168	435
Pull Back Kit With Rubber Edge		
Factory Installed (ordered with Snow Push) Add weight to ordered Snow Push		
8' Pull Back Kit with Rubber Edge	28-10753-96	245
10' Pull Back Kit with Rubber Edge	28-10753-120	300
12' Pull Back Kit with Rubber Edge	28-10753-144	350
14' Pull Back Kit with Rubber Edge	28-10753-168	410
Field Installed (After Market Kit)		
8' Pull Back Kit with Rubber Edge	28-10838-96	314
10' Pull Back Kit with Rubber Edge	28-10838-120	382
12' Pull Back Kit with Rubber Edge	28-10838-144	441
14' Pull Back Kit with Rubber Edge	28-10838-168	508

REPLACEMENT PARTS	ORDER CODE	SHIP WEIGHT (LBS)
Rubber Edge Kits (Includes Hardware and Retaining Plates)		
Rubber Edge Kits for Snow Push		
Rubber Edge Kit for 8' Snow Push	28-10841-96	130
Rubber Edge Kit for 10' Snow Push	28-10841-120	150
Rubber Edge Kit for 12' Snow Push	28-10841-144	170
Rubber Edge Kit for 14' Snow Push	28-10841-168	190
Rubber Edge Kits for Pullback Kit		
Rubber Edge Kit for 8' Pullback Kit	28-10840-96	90
Rubber Edge Kit for 10' Pullback Kit	28-10840-120	110
Rubber Edge Kit for 12' Pullback Kit	28-10840-144	125
Rubber Edge Kit for 14' Pullback Kit	28-10840-168	135
Snow Shoes		
Standard Duty Snow Shoe (1 shoe)	LAF3605-0000	50
Heavy Duty Snow Shoe (1 shoe)	13-18356	60

SNOW REMOVAL

SNOW PUSH

COMPACT TRACTOR SNOW PUSH



- Moves large volumes of snow efficiently. Also ideal for waste water, manure, feed lot and flood cleanup
- Optional pull back kit draws back snow from buildings, fences and confined areas

Carrier Specifications

Lift Capacity	Operating Weight
<2,000 lbs.	<4,000 lbs.

Compact Tractor Snow Push Specifications

Model	Path Width	Working Height	Depth	Overall Width	Weight (approx)
10707-60-0822	61.8"	30.8"	34"	62.3"	415 lbs
10707-72-0822	73.8"	30.8"	34"	74.3"	450 lbs
10707-84-0822	85.8"	30.8"	34"	86.3"	484 lbs
10707-96-0822	97.8"	30.8"	34"	98.3"	518 lbs

COMPACT TRACTOR SNOW PUSH



SNOW PUSH

ORDER CODE

SHIP WEIGHT (LBS)

Compact Tractor Snow Push includes Rubber Edge

5 ft Compact Tractor Snow Push	10707-60-0822	500
6 ft Compact Tractor Snow Push	10707-72-0822	530
7 ft Compact Tractor Snow Push	10707-84-0822	580
8 ft Compact Tractor Snow Push	10707-96-0822	625

REPLACEMENT PARTS

ORDER CODE

SHIP WEIGHT (LBS)

Rubber Edge Kits (Includes Hardware and Retaining Plates)

Rubber Edge Kit for 5' Snow Push	28-10840-60	60
Rubber Edge Kit for 6' Snow Push	28-10840-72	70
Rubber Edge Kit for 7' Snow Push	28-10840-84	80
Rubber Edge Kit for 8' Snow Push	28-10840-96	90

SNOW PUSH

COMPACT TRACTOR TRIP EDGE SNOW PUSH



- Moves large volumes of snow efficiently. Also ideal for waste water, manure, feed lot and flood cleanup
- Optional pull back kit draws back snow from buildings, fences and confined areas

Carrier Specifications	
Lift Capacity	Operating Weight
<4,000 lbs.	<8,000 lbs.

Compact Tractor Trip Edge Models Snow Push Specifications					
Model	Path Width	Working Height	Depth	Overall Width	Weight (approx)
10709-78-0822	72.9"	39.8"	44.1"	80.4"	850 lbs
10709-96-0822	90.9"	39.8"	44.1"	98.4"	930 lbs
10709-08-0822	102.9"	39.8"	44.1"	110.4"	990 lbs
10709-20-0822	112.4"	39.8"	44.1"	119.9"	1030 lbs

COMPACT TRACTOR TRIP EDGE SNOW PUSH



SNOW PUSH	ORDER CODE	SHIP WEIGHT (LBS)
Compact Tractor Trip Edge Snow Push includes Steel Edge		
6.5 ft Compact Tractor Trip Edge Snow Push	10709-78-0822	920
8 ft Compact Tractor Trip Edge Snow Push	10709-96-0822	970
9 ft Compact Tractor Trip Edge Snow Push	10709-08-0822	1020
10 ft Compact Tractor Trip Edge Snow Push	10709-20-0822	1140

OPTIONS	ORDER CODE	SHIP WEIGHT (LBS)
Pull Back Kit Without Rubber Edge		
Factory Installed (ordered with Snow Push) Add weight to ordered Snow Push		
6.5' Pull Back Kit w/out Rubber Edge	28-10468	180
8' Pull Back Kit w/out Rubber Edge	28-10469	200
9' Pull Back Kit w/out Rubber Edge	28-10470	215
10' Pull Back Kit w/out Rubber Edge	28-10471	230
Field Install (After Market Kit)		
6.5' Pull Back Kit w/out Rubber Edge for 10709-78 Snow Push	10740-FFC	230
8' Pull Back Kit w/out Rubber Edge for 10709-96 Snow Push	10730-FFC	255
9' Pull Back Kit w/out Rubber Edge for 10709-08 Snow Push	10731-FFC	275
10' Pull Back Kit w/out Rubber Edge for 10709-20 Snow Push	10732-FFC	295

COMPACT TRACTOR TRIP EDGE SNOW PUSH CONTINUED NEXT PAGE

SNOW REMOVAL

SNOW PUSH

COMPACT TRACTOR TRIP EDGE SNOW PUSH CONT.

OPTIONS CONT.	ORDER CODE	SHIP WEIGHT (LBS)
Pull Back Kit With Rubber Edge		
Factory Installed (ordered with Snow Push) Add weight to ordered Snow Push		
6.5' Pull Back Kit with Rubber Edge for 10709-78 Snow Push	28-10478	200
8' Pull Back Kit with Rubber Edge for 10709-96 Snow Push	28-10479	225
9' Pull Back Kit with Rubber Edge for 10709-08 Snow Push	28-10480	240
10' Pull Back Kit with Rubber Edge for 10709-20 Snow Push	28-10481	260
Field Install (After Market Kit)		
6.5' Pull Back Kit with Rubber Edge for 10709-78 Snow Push	28-10488	250
8' Pull Back Kit with Rubber Edge for 10709-96 Snow Push	28-10489	280
9' Pull Back Kit with Rubber Edge for 10709-08 Snow Push	28-10490	300
10' Pull Back Kit with Rubber Edge for 10709-20 Snow Push	28-10491	325

REPLACEMENT PARTS	ORDER CODE	SHIP WEIGHT (LBS)
Cutting Edge Kits (Includes Hardware)		
Steel Edge Kits for Snow Push		
Steel Edge Kit for 6.5' Snow Push	11614	100
Steel Edge Kit for 8' Snow Push	11610	120
Steel Edge Kit for 9' Snow Push	11611	140
Steel Edge Kit for 10' Snow Push	28-10839	160
Rubber Edge Kits for Pullback Kit		
Rubber Edge Kit for 6.5' Pullback Kit	28-10840-84	90
Rubber Edge Kit for 8' Pullback Kit	28-10840-96	110
Rubber Edge Kit for 9' Pullback Kit	28-10840-108	125
Rubber Edge Kit for 10' Pullback Kit	28-10840-120	135

STRIKEFORCE™



STRIKEFORCE

STRIKEFORCE BREAKERS



- Box style breaker - Reduced noise pollution & carrier protection
- Hybrid Gas/oil working principle - High efficiency & impact energy
- Internal Control Valve - Higher efficiency, performance & reliability
- 2 moving parts - Reduced maintenance higher ROI

SPECIFICATIONS

Model	Tool Diameter	Suitable Carrier	Required Oil Flow	Operating Pressure	Blow Range - Power Mode	Blow Range - Speed Mode
SFB 150-2	1.57"	1100~3300 lbs	4~6 GPM	860~890 PSI	800~1200 BPM	800~1200 BPM
SFB 250-2	1.77"	1800~6600 lbs	4~8 GPM	1300~1740 PSI	550~1000 BPM	550~1000 BPM
SFB 350-2	2.24"	3300~11000 lbs	6~19 GPM	1300~1740 PSI	600~1500 BPM	600~1500 BPM
SFB 500-2	2.76"	8800~15500 lbs	8~16 GPM	1600~2400 PSI	380~1500 BPM	380~1500 BPM
SFB 750-2	2.95"	11000~19900 lbs	9~18 GPM	1740~2400 PSI	380~900 BPM	380~900 BPM
SFB 1000-2	3.15"	13300~22100 lbs	10~22 GPM	2030~2470 PSI	400~800 BPM	600~1100 BPM
SFB 1500-2	3.54"	15500~26500 lbs	11~22 GPM	2030~2470 PSI	350~700 BPM	490~1000 BPM

STRIKEFORCE BREAKERS

BREAKERS	ORDER CODE	SHIP WEIGHT (LBS)
SFB 150-2 Breaker, Single Bracket		180
SFB 150-2 Breaker, Combo Bracket		180
SFB 250-2 Breaker, Single Bracket		310
SFB 250-2 Breaker, Combo Bracket		310
SFB 350-2 Breaker, Single Bracket		410
SFB 350-2 Breaker, Combo Bracket		410
SFB 500-2 Breaker, Single Bracket		720
SFB 500-2 Breaker, Combo Bracket		720
SFB 750-2 Breaker, Single Bracket		910
SFB 750-2 Breaker, Combo Bracket		940
SFB 1000-2 Breaker, Single Bracket		1140
SFB 1000-2 Breaker, Combo Bracket		1140
SFB 1500-2 Breaker, Single Bracket		1320

STRIKEFORCE PLATE COMPACTORS



- "Outboard" shock isolator location provides stability for optimal transmission of impulse for effective compaction
- Shock isolators are angled to reduce damaging shear stresses in the isolator and extend life while providing a performance advantage in delivering compaction forces to the soil
- Integral Flow Control block manages flow and pressure to provide effective and repeatable compaction as well as to protect the hydraulic motor
- Oil bath bearing design maximizes bearing life while minimizing maintenance needs

SPECIFICATIONS							
MODEL	OVERALL WIDTH	OVERALL LENGTH	OVERALL HEIGHT	COMPACTION AREA	CARRIER WEIGHT - MINIMUM	CARRIER WEIGHT - MAXIMUM	IMPULSE FORCE
TPC250	11.75"	30"	18.8"	353 in ²	2700 lbs	10000 lbs	2500 lbs
TPC350	18.75"	26"	19.1"	488 in ²	2700 lbs	14000 lbs	3400 lbs
TPC1000	23.5"	35"	22.9"	823 in ²	13000 lbs	28000 lbs	6400 lbs
TPC2K	24"	38"	24.5"	912 in ²	13000 lbs	40000 lbs	8000 lbs
TPC4K	25.5"	38.5"	29.5"	982 in ²	13000 lbs	50000 lbs	11350 lbs
TPC10K	33"	49.5"	34.5"	1634 in ²	37000 lbs	130000 lbs	22000 lbs

STRIKEFORCE PLATE COMPACTORS

PLATE COMPACTORS	ORDER CODE	SHIP WEIGHT (LBS)
TPC250 Plate Compactor	245250-BLNK	305
TPC350 Plate Compactor	245350-BLNK	473
TPC1000 Plate Compactor	24501K-BLNK	891
TPC2K Plate Compactor	24502K-BLNK	1007
TPC4K Plate Compactor	24504K-BLNK	1553
TPC10K Plate Compactor	24510K-BLNK	2620

STUMP GRINDER

STUMP GRINDER



- Standard flow (SG26) & High Flow (SG30)
- Wheel Grinds stumps down to 12" below grade with 28 teeth
- Tooth bottom permits cutting from side-to-side and vertical directions
- 60° range of motion will cover 45" in a single sweep
- Grouser pad stabilization prevents plunge stalls
- Dial adjust swing speed

Specifications

Model	Width	Height	Length	Below Ground Depth	Swing Arc	Wheel Dia.	GPM	Weight lbs.
SG26	58"	37"	73"	10"	60°	26"	16-23	720
SG30	58"	37"	73"	12"	60°	30"	29-44	795

STUMP GRINDER FOR SKID-STEER LOADERS



TO ORDER: CHOOSE STUMP GRINDER, CONTROL, CUTTER WHEEL AND HYDRAULIC KIT

STUMP GRINDER ASSEMBLY

	ORDER CODE	SHIP WEIGHT (LBS)
SG26 standard flow - requires 26" diameter wheel 16 to 23 GPM flow	100319	720
SG30 high flow - requires 30" diameter wheel 29 to 44 GPM flow	100320	795

BUNDLED STUMP GRINDERS

includes Universal Mount, Host Kit (flat face couplers), wheel assembly with teeth as specified

	ORDER CODE	SHIP WEIGHT (LBS)
SSL SG26 Stump Grinder Square Bolt-on Teeth (16-23 gpm)	112582	9475
SSL SG26 Stump Grinder Shark Teeth (16-23 gpm)	112583	9505
SSL SG30 Stump Grinder Square Bolt-on Teeth (29-44 gpm)	112584	10,545
SSL SG30 Stump Grinder Shark Teeth (29-44 gpm)	112585	10,600

HYDRAULIC CONTROL AND WIRE HARNESS OPTIONS (MUST CHOOSE ONE)

	ORDER CODE	SHIP WEIGHT (LBS)
Control box w/ power lead	28-10754	5
Wire harness for CAT (14-pin "D" series)	07-8344	5
Wire harness for CAT pre-B (8-pin Deutsch)	07-10021	5
Wire harness for standard flow attachments on CAT B and C (8-pin Deutsch)	07-10122	5
Wire harness for John Deere-8 button (14-pin Deutsch)	LAF9361	5
Wire harness for John Deere EH control (14-pin Deutsch)	07-7626	5
Wire harness for John Deere (3-pin Deutsch)	07-7338	5
Wire harness for Komatsu (14-pin Deutsch)	07-10194	5
Wire harness for Komatsu (8-pin Deutsch)	07-10057	5
Wire Harness (multi function in cab controls) for CNH, JCB, Bobcat, Mustang, Kubota, Takeuchi, Volvo 14 Pin-8 Pin	LAF9360-0000	5
Wire harness for CNH (8-pin rectangular)	LAF9393	5

STUMP GRINDER CONTINUED NEXT PAGE

STUMP GRINDER

STUMP GRINDER FOR SKID-STEER LOADERS CONT.

CUTTER WHEEL	ORDER CODE	SHIP WEIGHT (LBS)
26" square threaded single-bolt tooth	101234	140
26" bolt-on shark style tooth	101243	170
30" square threaded single-bolt tooth	100418	160
30" bolt-on shark style tooth	100416	215

HYDRAULIC KITS	ORDER CODE	SHIP WEIGHT (LBS)
(2) 72"x.62 hoses .50" flat face couplers (standard flow) 14 to 28 GPM	100983	15
(2) 88"x.62 hoses .50" flat face couplers (standard flow) 14 to 28 GPM	100984	10
(2) 88"x.75 hose .50 flat face couplers (high flow) 29 to 44 GPM	117736	28
(2) 72"x.75 hoses .625" flat face couplers (high flow) 29 to 44 GPM	101754	24
(2) 88"x.75 hoses .625" flat face couplers (high flow) 29 to 44 GPM	101755	28
(2) 72"x.75 hoses .75" flat face couplers (high flow) 29 to 44 GPM	102073	24
(2) 88"x.75 hoses .75" flat face couplers (high flow) 29 to 44 GPM	102074	28

REPLACEMENT PARTS	ORDER CODE	SHIP WEIGHT (LBS)
(28) replacement square tooth kit assembly	102075	15
(32) replacement bolt-on shark style tooth	102076	45
Stump Grinder guard kit	123465	65

SWEEPERS



SWEEPERS

Sweepster by Paladin, provides high quality sweepers and replacement brushes that are durable enough to perform under the most challenging conditions. Sweepster is the industry leader in rotary brooms and offers a complete line of sweepers for every prime mover and application.



Sweepster Sweepers are capable of handling all types of material including fine dirt, gravel, mud, millings and other debris.

- The only waterless dust mitigation system (patented)
- Higher capacity buckets (22%) equal high performance and increased efficiency (available on selected models)
- Multiple Sweeper types:
 - ~ Angle Sweepers
 - ~ Collector Sweepers
 - ~ Collector Sweepers with waterless dust abatement (patented and exclusive to Paladin)
- Tool-less Quick Change Core and many other standard features

HOW TO ORDER AN ATTACHMENT

Since many of our attachments are customized to your needs, when you place your order you will need to choose your attachment, the mounting, and any options you would like. As you look through the products, notice the red headings in the charts - they will alert you to the choices you need to make.

Choose your attachment

BRUSH HEAD AND BRUSH MATERIAL		ORDER CODE	SHIP WEIGHT (LBS)
Front-Mount Hydraulic Drive Brush Head - All Polypropylene Brush GPM Range 8-15			
S26 4 ft hydraulic brush head		S26P4SM14	340
S26 5 ft hydraulic brush head		S26P5SM14	370
S26 6 ft hydraulic brush head		S26P6SM14	400

Choose a mount

MOUNTING AND SWING ASSEMBLY (ONE REQUIRED)		ORDER CODE	SHIP WEIGHT (LBS)
Contact Customer Service for Mounting Availability			
mounting & swing with hydraulic pump and tank for out front mowers		CMSH	240
mounting & swing without hydraulic pump and tank for out front mowers		CMSMH	100

The blue information bar will tell you what is included in the price and what you need to choose to order a complete attachment. It may also include other helpful information.



TO ORDER: CHOOSE BRUSH HEAD & BRUSH MATERIAL, MOUNTING AND HYDRAULIC CONTROL PACKAGE INCLUDES: BRUSH HEAD & BRUSH MATERIAL AND MOUNT FOR CAT II OR CAT III 3-PT HITCH.

The warning box contains important information pertaining to the attachment and prime mover and/or other safety information.



IMPORTANT: Mounting & swing assembly requires 12 to 16 gpm at 2000 psi to operate sweeper



IMPORTANT: Must Ship Via Flatbed Motor Freight, Call Customer Service for Estimate

If you have any questions about placing your order, contact Customer Service at (833) 723-1843.

SSL ANGLE SWEEPER-HYDRAULIC DRIVE (QCSS ANGLE)



- Drive slips out of core without removing hydraulic lines from wheel motor
- Brush core is reversible for even brush wear
- 32" diameter brush for longer life
- Angles manually or hydraulically 30° left/right
- Faceted hood design provides maximum strength at ends of the hood
- Choose poly or poly/wire brush
- Includes skid steer mounting
- Single direction is standard

Specifications						
Model #	Sweeping Width	Sweeping Width @ 30°	Motors	Brush Diameter	Weight (approx.)	GPM Range
22059	60"	54"	single	32"	793	10-18
22060	60"	54"	single	32"	793	12-25
22061	60"	54"	dual	32"	829	18-36
22071	72"	64"	single	32"	852	10-18
22072	72"	64"	single	32"	852	12-25
22073	72"	64"	dual	32"	890	18-36
22083	84"	75"	single	32"	915	10-18
22084	84"	75"	single	32"	915	12-25
22085	84"	75"	dual	32"	953	18-36
22096	96"	85"	single	32"	982	12-25
22097	96"	85"	dual	32"	1,022	18-36

HOW TO ORDER YOUR SWEEPER

Step 1:
Choose Sweeper

Step 2:
Choose Angle Control

Step 3:
Choose Mount

example: 22260P + M + 0022 = 22260PM-0022

SSL ANGLE SWEEPER-HYDRAULIC DRIVE (QCSS ANGLE)



BRUSH HEAD AND BRUSH MATERIAL	ORDER CODE	SHIP WEIGHT (LBS)
BRUSH HEAD WITH SINGLE MOTOR - 10-18 GPM, 2000-3500 PSI		
Brush Head with Single 18" Cubic Inch Motor (SM18) - All Polypropylene Brush		
QC 5 ft hydraulic drive brush head	22059P	793
QC 6 ft hydraulic drive brush head	22071P	852
QC 7 ft hydraulic drive brush head	22083P	915
Brush Head with Single Motor - Polypropylene & Wire Brush		
QC 5 ft hydraulic drive brush head	22059M	793
QC 6 ft hydraulic drive brush head	22071M	852
QC 7 ft hydraulic drive brush head	22083M	915

BRUSH HEADS CONTINUED NEXT PAGE

SWEEPERS

SSL ANGLE SWEEPER-HYDRAULIC DRIVE (QCSS ANGLE) CONT.

BRUSH HEAD AND BRUSH MATERIAL	ORDER CODE	SHIP WEIGHT (LBS)
BRUSH HEAD WITH SINGLE MOTOR - 12-25 GPM, 2000-3000 PSI		
Brush Head with Single Motor - All Polypropylene Brush		
QC 5 ft hydraulic drive brush head	22060P	831
QC 6 ft hydraulic drive brush head	22072P	890
QC 7 ft hydraulic drive brush head	22084P	953
QC 8 ft hydraulic drive brush head	22096P	1020
Brush Head with Single Motor - Polypropylene & Wire Brush		
QC 5 ft hydraulic drive brush head	22060M	831
QC 6 ft hydraulic drive brush head	22072M	890
QC 7 ft hydraulic drive brush head	22084M	953
QC 8 ft hydraulic drive brush head	22096M	1020
BRUSH HEAD WITH DUAL MOTOR - 20-36 GPM, 2000-3500 PSI		
Brush Head with Dual Motor - All Polypropylene Brush GPM		
QC 5 ft hydraulic drive brush head	22061P	831
QC 6 ft hydraulic drive brush head	22073P	890
QC 7 ft hydraulic drive brush head	22085P	953
QC 8 ft hydraulic drive brush head	22097P	1020
Brush Head with Dual Motor - Polypropylene & Wire Brush		
QC 5 ft hydraulic drive brush head	22061M	831
QC 6 ft hydraulic drive brush head	22073M	890
QC 7 ft hydraulic drive brush head	22085M	953
QC 8 ft hydraulic drive brush head	22097M	1020
ANGLE TYPE MANUAL OR HYDRAULIC (ONE REQUIRED)		
	ORDER CODE	SHIP WEIGHT (LBS)
Contact Customer Service for Mounting Information on Specific Tractors		
manual angle change	M	n/a
hydraulic angle change with electric valve 12 volt	H	22
hydraulic angle change with electric valve 24 volt	H2	22
hydraulic angle change cylinder and 72" hoses	H3	10
hydraulic angle change cylinder and 144" hoses	H4	20
hydraulic angle change cylinder only - no hoses	H5	17
MOUNTING (ONE REQUIRED)		
	ORDER CODE	SHIP WEIGHT (LBS)
Contact Customer Service for Additional Mounting Availability		
universal skid steer mounting	0022	n/a

SSL ANGLE SWEEPER-HYDRAULIC DRIVE (QCSS ANGLE) CONT.

HYDRAULIC CONTROL OPTIONS (ONE REQUIRED)	ORDER CODE	SHIP WEIGHT (LBS)
7-pin for Bobcat	07-9548	5
Control box w/ power lead	28-10754	5
Wire harness for CAT pre-B (8-pin Deutsch)	07-10021	5
Wire harness for standard flow attachments on CAT B and C (8-pin Deutsch)	07-10122	5
Wire harness for CAT (14-pin "D" series)	07-8344	1
Wire Harness (multi function in cab controls) for CNH, JCB, Bobcat, Mustang, Kubota, Takeuchi, Volvo 14 Pin-8 Pin	LAF9360-0000	5
Wire harness for CNH (8-pin rectangular)	LAF9393	5
Wire harness for John Deere (3-pin Deutsch)	07-7338	5
Wire harness for John Deere-8 button (14-pin Deutsch)	LAF9361	5
Wire harness for John Deere EH control (14-pin Deutsch)	07-7626	5
Wire harness for Komatsu (14-pin Deutsch)	07-10194	5
Wire harness for Komatsu (8-pin Deutsch)	07-10057	5
60" of extra cable for H or H2	07-7887	2

OPTIONS	ORDER CODE	SHIP WEIGHT (LBS)
sight indicator flag	11-5897	10
sight indicator ball	28-9965	10
Sprinkler Kits (select system and tank to complete kit)		
Kit 12V pump/filter/nozzles/no tank - Field Installed	28-9919*	25
Kit 12V pump/filter/nozzles/no tank - Factory Installed	28-10114	25
Kit 25 gal Tank w/shut-off	28-4319**	75
180 Hood - Factory Installed		
for QC-5	28-10311-5	50
for QC-6	28-10311-6	55
for QC-7	28-10311-7	60
for QC-8	28-10311-8	65
180 Hood - Field Installed		
for QC-5	28-10361-5	50
for QC-6	28-10361-6	55
for QC-7	28-10361-7	60
for QC-8	28-10361-8	65
Drape Deflector Includes 180 Hood - Factory Installed		
for QC-5	28-10312-5	65
for QC-6	28-10312-6	70
for QC-7	28-10312-7	75
for QC-8	28-10312-8	80
Drape Deflector Includes 180 Hood - Field Installed		
for QC-5	28-10362-5	65
for QC-6	28-10362-6	70
for QC-7	28-10362-7	75
for QC-8	28-10362-8	80

*customer supplied water source or other suitable kit required

**customer supplied mounting system required (do not mount directly to sweeper hood)

SWEEPERS

TRUCK AND LARGE WHEEL LOADER ANGLE SWEEPER - HYDRAULIC DRIVE (WLA)



- 10 ft & 12 ft wide models available
- 36" diameter brush
- Dual motor design for high torque
- Quick change brush without breaking hydraulic lines
- Third valve required to operate - fourth valve required to operate optional hydraulic angle change
- Parallel linkage allows sweeper to follow ground contours
- Angles manually or hydraulically 30° left/right
- Choose poly or poly/wire brush

Specifications							
Model #	Sweeping Width	Sweeping Width @ 30°	Motors	Brush Diameter	Weight (approx.)	GPM Range	PSI Range
21319	120"	104"	dual	36"	1943 lbs	12-30	3000-4500
21320	120"	104"	dual	36"	1943 lbs	18-45	2300-4000
21321	120"	104"	dual	36"	1943 lbs	24-60	2000-3500
21344	144"	129"	dual	36"	2332 lbs	18-45	2300-4000
21345	144"	129"	dual	36"	2332 lbs	24-60	2000-3500

HOW TO ORDER YOUR SWEEPER



example: 21319P + M + LAF1661-0913 = 21319PM LAF1661-0913

TRUCK AND LARGE ARTICULATED WHEEL LOADER ANGLE SWEEPER - HYDRAULIC DRIVE (WLA)



BRUSH HEAD AND BRUSH MATERIAL	ORDER CODE	SHIP WEIGHT (LBS)
Hydraulic Drive Brush Head - All Polypropylene Brush GPM Range 12-30, PSI Range 3000-4500		
WLA 10 ft hydraulic drive brush head	21319P	1943
WLA 12 ft hydraulic drive brush head	21343P	2332
Hydraulic Drive Brush Head - Polypropylene and Wire Brush		
WLA 10 ft hydraulic drive brush head	21319M	1943
WLA 12 ft hydraulic drive brush head	21343M	2332
Hydraulic Drive Brush Head - All Polypropylene Brush GPM Range 18-45, PSI Range 2300-4000		
WLA 10 ft hydraulic drive brush head	21320P	1943
WLA 12 ft hydraulic drive brush head	21344P	2332
Hydraulic Drive Brush Head - Polypropylene and Wire Brush		
WLA 10 ft hydraulic drive brush head	21320M	1943
WLA 12 ft hydraulic drive brush head	21344M	2332

TRUCK AND LARGE ARTICULATED WHEEL LOADER ANGLE SWEEPER - HYDRAULIC DRIVE (WLA) CONT.

BRUSH HEAD AND BRUSH MATERIAL CONT.		ORDER CODE	SHIP WEIGHT (LBS)
Hydraulic Drive Brush Head - All Polypropylene Brush GPM Range 24-60, PSI Range 2000-3500			
WLA 10 ft hydraulic drive brush head		21321P	1943
WLA 12 ft hydraulic drive brush head		21345P	2332
Hydraulic Drive Brush Head - Polypropylene and Wire Brush			
WLA 10 ft hydraulic drive brush head		21321M	1943
WLA 12 ft hydraulic drive brush head		21345M	2332
ANGLE TYPE MANUAL OR HYDRAULIC (ONE REQUIRED)		ORDER CODE	SHIP WEIGHT (LBS)
manual angle change		M	15
hydraulic angle change with electric valve 12 volt		H	40
hydraulic angle change with electric valve 24 volt		H2	40
hydraulic angle change cylinder and 72" hoses		H3	10
hydraulic angle change cylinder and 144" hoses		H4	30
hydraulic angle change cylinder only - no hoses		H5	17
5 ft of extra cable (Optional - not required)		07-7155	2
MOUNTING (ONE REQUIRED)			
Refer to mounts in LA Broom section, page 257			
OPTIONS		ORDER CODE	SHIP WEIGHT (LBS)
case drain kit for loaders with more than 750 PSI back pressure at 250 RPM		28-10040S	60
Sprinkler Systems - Field Installed			
sprinkler system tank 85 gallon with mounting and shut-off		28-4318	125
10ft & 12ft sprinkler system pump, filter, nozzles, 12 volt		28-9928	30
10ft & 12ft sprinkler system pump, filter, nozzles, 24 volt		28-10092	30
180 Hood - Factory Installed			
for WLA-10		28-10104-10	65
for WLA-12		28-10104-12	70
180 Hood - Field Installed			
for WLA-10		28-9932-10	65
for WLA-12		28-9932-12	70
Drape Deflector Includes 180 Hood - Factory Installed			
for WLA-10		28-10093-10	80
for WLA-12		28-10093-12	85
Drape Deflector Includes 180 Hood - Field Installed			
for WLA-10		28-9927-10	80
for WLA-12		28-9927-12	85

SWEEPERS

SWEEPERS

TRUCK AND WHEEL LOADER ANGLE SWEEPER - HYDRAULIC DRIVE (LA)



- 32" bristles extend brush life
- Drive slips out of core without removing hydraulic lines from wheel motor
- Brush core is reversible for even brush wear
- Powered by hydraulic motors mounted inside brush frame
- Third valve required to operate - fourth valve required to operate optional hydraulic angle change
- Parallel linkage with casters allows sweeper to follow ground contours
- Angles manually or hydraulically 30° left/right
- Choose poly or poly/wire brush
- Casters, standard

Specifications

Model #	Sweeping Width	Sweeping Width @ 30°	Motors	Brush Diameter	Weight (approx.)	GPM Range	PSI Range
22197	96"	83"	dual	32"	1288 lbs	20-36	2000-3500
22109	108"	94"	dual	32"	1,338 lbs	20-36	2000-3500

HOW TO ORDER YOUR SWEEPER

Step 1:
Choose Sweeper

Step 2:
Choose Angle Control

Step 3:
Choose Mount

example: 22197M + M + LAF1661-0913 = 22197MM
LAF1661-0913



TRUCK AND WHEEL LOADER ANGLE SWEEPER - HYDRAULIC DRIVE (LA)

BUSH HEAD AND BRUSH MATERIAL	ORDER CODE	SHIP WEIGHT (LBS)
Hydraulic Drive Brush Head - All Polypropylene Brush		
QC 8 ft hydraulic drive brush head	22197P	1612
QC 9 ft hydraulic drive brush head	22109P	1682
Hydraulic Drive Brush Head - Polypropylene and Wire Brush		
QC 8 ft hydraulic drive brush head	22197M	1612
QC 9 ft hydraulic drive brush head	22109M	1682

ANGLE TYPE MANUAL OR HYDRAULIC (ONE REQUIRED)	ORDER CODE	SHIP WEIGHT (LBS)
manual angle change	M	15
hydraulic angle change with electric valve 12 volt	H	40
hydraulic angle change with electric valve 24 volt	H2	40
hydraulic angle change cylinder and 72" hoses	H3	10
hydraulic angle change cylinder and 144" hoses	H4	30
hydraulic angle change cylinder only - no hoses	H5	17
5 ft of extra cable (Optional - not required)	07-7155	2

TRUCK AND WHEEL LOADER ANGLE SWEEPER - HYDRAULIC DRIVE (LA)

MOUNTING (ONE REQUIRED)	ORDER CODE
CAT IT	LAF1661-0134
CAT Fusion	LAF1661-0217
CAT 908HC	LAF1661-0984
JRB 416	LAF1661-0913
JRB 418	LAF1661-0971
JRB E-Series	LAF1661-0869
JCB 411	LAF1661-0028
L90E / ISO	LAF1661-0934
Manitou	LAF1661-0620
QCP-7000	LAF1661-0733
WA200-5	LAF1661-0434
Zettelmeyer 602	LAF1661-0906

OPTIONS	ORDER CODE	SHIP WEIGHT (LBS)
storage stands	28-10397	60
sight indicator flag	11-5897	10
sight indicator ball	28-9965	10
Caster Options		
swing etc with heavy-duty tapered roller bearing casters	TRC	n/a
swing etc with heavy-duty solid caster wheels	SC	30
Sprinkler Kits (select one system and one tank to complete a kit)		
sprinkler system fits all nozzles and mounts to hood 12 volt factory installed	28-10114	24
sprinkler system fits all nozzles and mounts to hood 24 volt factory installed	28-10115	25
sprinkler system tank 25 gallon with mounting and shut-off	28-9524	75
sprinkler system tank 85 gallon with mounting and shut-off	28-4318	125
Independent Hydraulic System Pump Drive		
from rear PTO tank mount to 3-Point 20 GPM with pressure relief	11-7691	150
quick coupler kit for 3-Point hydraulic system	28-10014	24
180 Hood - Factory Installed		
for QC-8	28-10311-8	65
for QC-9	28-10311-9	70
180 Hood - Field Installed		
for QC-8	28-10361-8	65
for QC-9	28-10361-9	70
Drape Deflector Includes 180 Hood - Factory Installed		
for QC-8	28-10312-8	80
for QC-9	28-10312-9	85
Drape Deflector Includes 180 Hood - Field Installed		
for QC-8	28-10362-8	80
for QC-9	28-10362-9	85

SWEEPERS

COMMERCIAL TURF MOWER ANGLE SWEEPER - HYDRAULIC DRIVE (CTH)



- Angles manually 30° left or right; hydraulic angle kit also available
- Front PTO required
- Brush widths of 4', 5' and 6' available
- Uses mower lift
- Requires 15 to 30 HP

Specifications								
Model	14		18		Overall Width	Angle Type	Brush Diameter	Weight (Approx)
	GPM Range	PSI Range	GPM Range	PSI Range				
S26-4	8-15	1200-3500	10-18	1200-3500	48"	Manual	26"	340 lbs
S26-5	8-15	1200-3500	10/18	1200-3500	60"	Manual	26"	370 lbs
S26-6	8-15	1200-3500	10-18	1200-3500	72"	Manual	26"	500 lbs



IMPORTANT: Mounting & swing assembly requires 12 to 16 gpm at 2000 psi to operate sweeper

COMMERCIAL TURF MOWER ANGLE SWEEPER - HYDRAULIC DRIVE (CTH)



TO ORDER: CHOOSE BRUSH HEAD & BRUSH MATERIAL AND MOUNTING & SWING ASSEMBLY



BRUSH HEAD AND BRUSH MATERIAL	ORDER CODE	SHIP WEIGHT (LBS)
Front-Mount Hydraulic Drive Brush Head - All Polypropylene Brush GPM Range 8-15		
S26 4 ft hydraulic brush head	S26P4SM14	340
S26 5 ft hydraulic brush head	S26P5SM14	370
S26 6 ft hydraulic brush head	S26P6SM14	400
Front-Mount Hydraulic Drive Brush Head - Polypropylene & Wire Brush		
S26 4 ft hydraulic brush head	S26M4SM14	340
S26 5 ft hydraulic brush head	S26M5SM14	370
S26 6 ft hydraulic brush head	S26M6SM14	400
Front-Mount Hydraulic Drive Brush Head - All Polypropylene Brush		
S26 4 ft hydraulic brush head	S26P4SM18	340
S26 5 ft hydraulic brush head	S26P5SM18	370
S26 6 ft hydraulic brush head	S26P6SM18	400
Front-Mount Hydraulic Drive Brush Head - Polypropylene & Wire Brush		
S26 4 ft hydraulic brush head	S26M4SM18	340
S26 5 ft hydraulic brush head	S26M5SM18	370
S26 6 ft hydraulic brush head	S26M6SM18	400

COMMERCIAL TURF MOWER ANGLE SWEEPER - HYDRAULIC DRIVE (CTH) CONT.

MOUNTING AND SWING ASSEMBLY (ONE REQUIRED)	ORDER CODE	SHIP WEIGHT (LBS)
Contact Customer Service for Mounting Availability		
mounting & swing with hydraulic pump and tank for out front mowers	CMSH	240
mounting & swing without hydraulic pump and tank for out front mowers	CMSMH	100
OPTIONS	ORDER CODE	SHIP WEIGHT (LBS)
hydraulic angle change cylinder and 72" hoses	11-4191	6
hydraulic angle with electric valve and control box	11-5310	15
Side Mount Caster Wheels		
side mount caster wheels S26	28-10498	45
Dirt Deflector		
dirt deflector S26-4	28-10162-4	25
dirt deflector S26-5	28-10162-5	30
dirt deflector S26-6	28-10162-6	35

SWEEPERS

COMMERCIAL TURF MOWER ANGLE SWEEPER - MECHANICAL DRIVE (CTM)



- Angles manually 30° left or right; hydraulic angle kit also available
- Chain drive
- Front PTO required
- Uses mower lift
- Requires 15 to 30 HP

Specifications					
Model	Width	Angle (Left or Right)	Angle Type	Brush Diameter	Weight (Approx)
M24-4	48"	30°	manual	24"	223 lbs
M24-5	60"	30°	manual	24"	248 lbs
M24-6	72"	30°	manual	24"	273 lbs

COMMERCIAL TURF MOWER ANGLE SWEEPER - MECHANICAL DRIVE (CTM)



TO ORDER: CHOOSE BRUSH HEAD & BRUSH MATERIAL AND MOUNTING & SWING ASSEMBLY

BRUSH HEAD AND BRUSH MATERIAL	ORDER CODE	SHIP WEIGHT (LBS)
Mechanical Brush Head - All Polypropylene Brush		
M24 4 ft mechanical brush head	M24P4A	223
M24 5 ft mechanical brush head	M24P5A	248
M24 6 ft mechanical brush head	M24P6A	273
Mechanical Brush Head - Polypropylene & Wire Brush		
M24 4 ft mechanical brush head	M24C4A	223
M24 5 ft mechanical brush head	M24C5A	248
M24 6 ft mechanical brush head	M24C6A	273
MOUNTING AND SWING ASSEMBLY (ONE REQUIRED)	ORDER CODE	SHIP WEIGHT (LBS)
Contact Customer Service for Mounting Availability		
manual angle mounting & swing for out-front mowers	CMSM	100
manual angle mounting & swing for walk behind mowers	WBMSM	100
OPTIONS	ORDER CODE	SHIP WEIGHT (LBS)
hydraulic angle change cylinder and 72" hoses	11-4191	6
storage stands	13-0800	25
dirt deflector M24-4, M24-5	11-4414	25
dirt deflector 4 ft	28-10873-4	30
dirt deflector 5 ft	28-10873-5	40
side mount caster wheels	28-9543	35
frame mount caster wheels not available on all mountings	11-5818	35

COMPACT TRACTOR LOADER ANGLE SWEEPER - HYDRAULIC DRIVE (MRHL)



- Angles manually or hydraulically 30° left or right
- Brush drive slips easily out of the core without removing hydraulic lines
- Hydraulic motor driven from loader's hydraulic system
- For vehicles without adequate hydraulic systems, independent hydraulic system available

Specifications - S26 Sweeper

Model #	Width	Angle Type	Brush Diameter	Weight (approx.)	GPM Range	PSI Range
22248	48"	hydraulic/manual	26"	455 lbs	8-15	3000 max
22249	48"	hydraulic/manual	26"	460 lbs	10-18	3000 max
22260	60"	hydraulic/manual	26"	490 lbs	8-15	3000 max
22261	60"	hydraulic/manual	26"	500 lbs	10-18	3000 max
22272	72"	hydraulic/manual	26"	525 lbs	8-15	3000 max
22273	72"	hydraulic/manual	26"	535 lbs	10-18	3000 max

Specifications - S30 Sweeper

Model #	Width	Angle Type	Brush Diameter	Weight (approx.)	GPM Range	PSI Range
22560	60"	hydraulic/manual	30"	520 lbs	8-15	3000 max
22561	60"	hydraulic/manual	30"	525 lbs	10-18	3000 max
22572	72"	hydraulic/manual	30"	555 lbs	8-15	3000 max
22573	72"	hydraulic/manual	30"	565 lbs	10-18	3000 max
22585	84"	hydraulic/manual	30"	595 lbs	10-18	3000 max

COMPACT TRACTOR LOADER ANGLE SWEEPER - HYDRAULIC DRIVE (MRHL)



HOW TO ORDER YOUR SWEEPER

Step 1:
Choose Sweeper

Step 2:
Choose Angle Control

Step 3:
Choose Mount

example: 22260P + M + 0022 = 22260PM-0022

BRUSH HEAD AND BRUSH MATERIAL	ORDER CODE	SHIP WEIGHT (LBS)
26" DIAMETER BRUSH HEAD - 8-15 GPM		
26" Diameter Brush Heads - All Polypropylene Brush		
S26 4 ft hydraulic brush head	22248P	380
S26 5 ft hydraulic brush head	22260P	440
S26 6 ft hydraulic brush head	22272P	500
26" Diameter Brush Heads - Polypropylene & Wire Brush		
S26 4 ft hydraulic brush head	22248M	380
S26 5 ft hydraulic brush head	22260M	440

BRUSH HEAD AND BRUSH MATERIAL CONTINUED NEXT PAGE

SWEEPERS

COMPACT TRACTOR LOADER ANGLE SWEEPER - HYDRAULIC DRIVE (MRHL) CONT.

BRUSH HEAD AND BRUSH MATERIAL	ORDER CODE	SHIP WEIGHT (LBS)
26" DIAMETER BRUSH HEAD - 10-18 GPM		
S26 6 ft hydraulic brush head	22272M	500
26" Diameter Brush Heads - All Polypropylene Brush GPM Range 10-18		
S26 4 ft hydraulic brush head	22249P	380
S26 5 ft hydraulic brush head	22261P	440
S26 6 ft hydraulic brush head	22273P	500
26" Diameter Brush Heads - Polypropylene & Wire Brush		
S26 4 ft hydraulic brush head	22249M	380
S26 5 ft hydraulic brush head	22261M	440
S26 6 ft hydraulic brush head	22273M	500
30" DIAMETER BRUSH HEAD - 8-15 GPM		
30" Diameter Brush Heads - All Polypropylene Brush		
S30 5 ft hydraulic brush head	22560P	540
S30 6 ft hydraulic brush head	22572P	600
30" Diameter Brush Heads - Polypropylene & Wire Brush		
S30 5 ft hydraulic brush head	22560M	540
30" DIAMETER BRUSH HEAD - 10-18 GPM		
S30 6 ft hydraulic brush head	22572M	600
30" Diameter Brush Heads - All Polypropylene Brush GPM Range 10-18		
S30 5 ft hydraulic brush head	22561P	540
S30 6 ft hydraulic brush head	22573P	600
S30 7 ft hydraulic brush head	22585P	660
30" Diameter Brush Heads - Polypropylene & Wire Brush		
S30 5 ft hydraulic brush head	22561M	540
S30 6 ft hydraulic brush head	22573M	600
S30 7 ft hydraulic brush head	22585M	660

ANGLE TYPE MANUAL OR HYDRAULIC (ONE REQUIRED)	ORDER CODE	SHIP WEIGHT (LBS)
manual angle change	M	n/a
hydraulic angle change with electric valve - 12 volt	H	22
hydraulic angle change with electric valve - 24 volt	H2	22
hydraulic angle change cylinder and 72" hoses	H3	10
hydraulic angle change cylinder and 144" hoses	H4	20
hydraulic angle change cylinder only - no hoses	H5	17

MOUNTING (ONE REQUIRED)	ORDER CODE	SHIP WEIGHT (LBS)
Contact Customer Service for Additional Mounting Availability		
universal skid steer mounting for skid steers under 1300 lb lift capacity	0022	n/a
Standardized mounting with the exception of ACS, CAT Fusion and Bobcat X-Change		

COMPACT TRACTOR LOADER ANGLE SWEEPER - HYDRAULIC DRIVE (MRHL) CONT.

HYDRAULIC CONTROL OPTIONS (ONE REQUIRED)	ORDER CODE	SHIP WEIGHT (LBS)
Control box w/ power lead	28-10754	5
Wire harness for CAT pre-B (8-pin Deutsch)	07-10021	5
Wire harness for standard flow attachments on CAT B and C (8-pin Deutsch)	07-10122	5
Wire harness for CAT (14-pin "D" series)	07-8344	1
Wire Harness (multi function in cab controls) for CNH, JCB, Bobcat, Mustang, Kubota, Takeuchi, Volvo 14 Pin-8 Pin	LAF9360-0000	5
Wire harness for CNH (8-pin rectangular)	LAF9393	5
Wire harness for John Deere (3-pin Deutsch)	07-7338	5
Wire harness for John Deere-8 button (14-pin Deutsch)	LAF9361	5
Wire harness for John Deere EH control (14-pin Deutsch)	07-7626	5
Wire harness for Komatsu (14-pin Deutsch)	07-10194	5
Wire harness for Komatsu (8-pin Deutsch)	07-10057	5
60" of extra cable for H or H2	07-7887	2

OPTIONS	ORDER CODE	SHIP WEIGHT (LBS)
conversion kit manual to hydraulic with control box	11-5433	15
conversion kit manual to hydraulic without control box	11-4191	6
3-point mounted hydraulic system with tank, PTO driven pump & pressure relief	11-7692	144
quick coupler kit for 3-point hydraulic system	28-10014	24
Dirt Deflector		
dirt deflector S26/S30-4	28-10162-4	25
dirt deflector S26/S30-5	28-10162-5	30
dirt deflector S26/S30-6	28-10162-6	35
dirt deflector S30-7	28-10162-7	40
Side Mount Caster Wheels		
side mount caster wheels S26	28-10498	45
side mount caster wheels S30	28-10499	55

SWEEPERS

COMPACT TRACTOR ANGLE SWEEPER - HYDRAULIC DRIVE (MRH)



- Angles manually 30° left or right; hydraulic angle kit also available
- Mid or rear PTO required
- Brush widths of 4', 5' and 6' available
- Requires 15 to 25 HP

Specifications								
Model	14		18		Overall Width	Angle Type	Brush Diameter	Weight (Approx)
	GPM Range	PSI Range	GPM Range	PSI Range				
S26-4	8-15	1200-3500	10-18	1200-3500	48"	Manual	26"	380 lbs
S26-5	8-15	1200-3500	10-18	1200-3500	60"	Manual	26"	440 lbs
S26-6	8-15	1200-3500	10-18	1200-3500	72"	Manual	26"	500 lbs
S30-5	8-15	1200-3500	10-18	1200-3500	60"	Manual	30"	490 lbs
S30-6	8-15	1200-3500	10-18	1200-3500	72"	Manual	30"	550 lbs
S30-7	8-15	1200-3500	10-18	1200-3500	84"	Manual	30"	610 lbs

COMPACT TRACTOR ANGLE SWEEPER- HYDRAULIC DRIVE (MRH)



TO ORDER: CHOOSE BRUSH HEAD & BRUSH MATERIAL, MOUNTING & SWING ASSEMBLY, HYDRAULIC CONTROL OPTION AND MOUNTING

BRUSH HEAD AND BRUSH MATERIAL	ORDER CODE	SHIP WEIGHT (LBS)
26" DIAMETER BRUSH HEAD		
26" Diameter Brush Heads - All Polypropylene Brush GPM Range 8-15		
S26 4 ft hydraulic brush head	S26P4SM14	340
S26 5 ft hydraulic brush head	S26P5SM14	370
S26 6 ft hydraulic brush head	S26P6SM14	400
26" Diameter Brush Heads - Polypropylene & Wire Brush		
S26 4 ft hydraulic brush head	S26M4SM14	340
S26 5 ft hydraulic brush head	S26M5SM14	370
S26 6 ft hydraulic brush head	S26M6SM14	400
26" Diameter Brush Heads - All Polypropylene Brush GPM Range 10-18		
S26 4 ft hydraulic brush head	S26P4SM18	340
S26 5 ft hydraulic brush head	S26P5SM18	370
S26 6 ft hydraulic brush head	S26P6SM18	400
26" Diameter Brush Heads - Polypropylene & Wire Brush		
S26 4 ft hydraulic brush head	S26M4SM18	340
S26 5 ft hydraulic brush head	S26M5SM18	370
S26 6 ft hydraulic brush head	S26M6SM18	400

BRUSH HEAD AND BRUSH MATERIAL CONTINUED NEXT PAGE

COMPACT TRACTOR ANGLE SWEEPER-HYDRAULIC DRIVE (MRH)

BRUSH HEAD AND BRUSH MATERIAL CONT.	ORDER CODE	SHIP WEIGHT (LBS)
30" DIAMETER BRUSH HEAD		
30" Diameter Brush Heads - All Polypropylene Brush GPM Range 8-15		
S30 5 ft hydraulic brush head	S30P5SM14	420
S30 6 ft hydraulic brush head	S30P6SM14	450
S30 7 ft hydraulic brush head	S30P7SM14	480
30" Diameter Brush Heads - Polypropylene & Wire Brush		
S30 5 ft hydraulic brush head	S30M5SM14	420
S30 6 ft hydraulic brush head	S30M6SM14	450
S30 7 ft hydraulic brush head	S30M7SM14	480
30" Diameter Brush Heads - All Polypropylene Brush GPM Range 10-18		
S30 5 ft hydraulic brush head	S30P5SM18	420
S30 6 ft hydraulic brush head	S30P6SM18	450
S30 7 ft hydraulic brush head	S30P7SM18	480
30" Diameter Brush Heads - Polypropylene & Wire Brush		
S30 5 ft hydraulic brush head	S30M5SM18	420
S30 6 ft hydraulic brush head	S30M6SM18	450
S30 7 ft hydraulic brush head	S30M7SM18	480

MOUNTING AND SWING ASSEMBLY (ONE REQUIRED)	ORDER CODE	SHIP WEIGHT (LBS)
Contact Customer Service for Mounting Availability		
rear mounted hydraulic pump & tank for compact utility tractors	THMSMR	240
mid mounted hydraulic pump & tank for compact utility tractors	THMSMM	240

OPTIONS	ORDER CODE	SHIP WEIGHT (LBS)
hydraulic angle no valve (for manual angle sweepers only)	11-4191	6
hydraulic angle with electric valve and box	11-5310	15
3-point mounted hydraulic system with tank, PTO driven pump & pressure relief	11-7692	144
quick coupler kit for 3-point hydraulic system	28-10014	24
Dirt Deflector		
dirt deflector S26/S30-4	28-10162-4	25
dirt deflector S26/S30-5	28-10162-5	30
dirt deflector S26/S30-6	28-10162-6	35
dirt deflector S30-7	28-10162-7	40
Side Mount Caster Wheels		
side mount caster wheels S26	28-10498	45
side mount caster wheels S30	28-10499	55

SWEEPERS

SWEEPERS

COMPACT TRACTOR ANGLE SWEEPER- MECHANICAL PTO DRIVE (RMRM)



- Angles manually 30° left or right;
- Driven from rear 540 PTO
- Includes steel hood, chain shield, height adjustment chains & mounting pins
- T-Shaft gearbox allows for reversal of brush rotation on mechanical drive

Specifications					
Model #	Width	Path @ 30° Angle	Weight (approx)	Brush Diameter	Storage Stands
RMRM4	48"	40"	370 lbs	24"	optional
RMRM5	60"	52"	430 lbs	24"	optional
RMRM6	72"	64"	490 lbs	24"	optional

COMPACT TRACTOR ANGLE SWEEPER - MECHANICAL PTO DRIVE (RMRM)



TO ORDER: CHOOSE BRUSH HEAD & BRUSH MATERIAL AND MOUNTING DRIVE

BRUSH HEAD AND BRUSH MATERIAL	ORDER CODE	SHIP WEIGHT (LBS)
Mechanical Brush Head - All Polypropylene Brush		
RM24 4 ft mechanical brush head	M24P4A	370
RM24 5 ft mechanical brush head	M24P5A	430
RM24 6 ft mechanical brush head	M24P6A	490
Mechanical Brush Head - Polypropylene & Wire Brush		
RM24 4 ft mechanical brush head	M24C4A	370
RM24 5 ft mechanical brush head	M24C5A	430
RM24 6 ft mechanical brush head	M24C6A	490
MOUNTING & DRIVE (REQUIRED)	ORDER CODE	SHIP WEIGHT (LBS)
Category 1 3-Point mounting assembly	11-17383	135
OPTIONS	ORDER CODE	SHIP WEIGHT (LBS)
hydraulic angle no valve	11-4191	6
storage stands	13-0800	25
side mount caster wheels	28-9543	35

UTILITY TRACTOR REAR MOUNT ANGLE SWEEPER - MECHANICAL 3-POINT DRIVE (RHFA)



- Angles manually 30° left or right;
- Driven from rear 540 PTO
- Includes steel hood, chain shield, height adjustment chains & mounting pins
- T-Shaft gearbox allows for reversal of brush rotation on mechanical drive
- Machine needs to be over 30HP

Specifications					
Model #	Width	Path @ 30° Angle	Weight (approx)	Brush Diameter	Storage Stands
RHFA5	60"	52"	750 lbs	32"	standard
RHFA6	72"	64"	850 lbs	32"	standard
RHFA7	84"	76"	950 lbs	32"	standard
RHFA8	96"	88"	1,050 lbs	32"	standard



UTILITY TRACTOR REAR MOUNT ANGLE SWEEPER - MECHANICAL 3-POINT DRIVE (RHFA)



TO ORDER: CHOOSE BRUSH HEAD & BRUSH MATERIAL, ANGLE AND MOUNTING

BRUSH HEAD AND BRUSH MATERIAL	ORDER CODE	SHIP WEIGHT (LBS)
Mechanical Brush Head - All Polypropylene Brush		
RHFA 5 ft mechanical brush head	RHFA5P	750
RHFA 6 ft mechanical brush head	RHFA6P	850
RHFA 7 ft mechanical brush head	RHFA7P	950
RHFA 8 ft mechanical brush head	RHFA8P	1050
Mechanical Brush Head - Polypropylene & Wire Brush		
RHFA 5 ft mechanical brush head	RHFA5M	750
RHFA 6 ft mechanical brush head	RHFA6M	850
RHFA 7 ft mechanical brush head	RHFA7M	950
RHFA 8 ft mechanical brush head	RHFA8M	1050
ANGLE MANUAL OR HYDRAULIC (ONE REQUIRED)	ORDER CODE	SHIP WEIGHT (LBS)
manual angle link	M	6
hydraulic angle cylinder & 72" hose no valve, hydraulic couplers not included	H	20
MOUNTING (ONE REQUIRED)	ORDER CODE	SHIP WEIGHT (LBS)
Cat I & Cat II 3-Point Mounting Assembly	-0052	n/a

Standardized mounting with the exception of ACS, CAT Fusion and Bobcat X-Change

SWEEPERS

UTILITY TRACTOR REAR MOUNT ANGLE SWEEPER - MECHANICAL 3-POINT DRIVE (RHFA) CONT.

OPTIONS	ORDER CODE	SHIP WEIGHT (LBS)
casters	13-1603	100
sight indicator flags	11-5897	10
sight indicator balls	28-9965	10
steel dirt deflector	RHFADD	75
rubber dirt deflector flap	28-9951	65
Sprinkler System (select both items below to complete kit)		
sprinkler system tank 25 gallon with mounting and shut off (Cat I only)	11-5739	75
sprinkler system no tank kit 12v for all lengths - field installed	28-9919*	25
sprinkler system pump, filter, nozzles 12V - factory installed	28-10114	25
180 Hood - Factory Installed		
for RHFA 5	28-9783	50
for RHFA 6	28-9784	55
for RHFA 7	28-9785	60
for RHFA 8	28-9786	65
180 Hood - Field Installed		
for RHFA 5	28-9722	50
for RHFA 6	28-9723	55
for RHFA 7	28-9724	60
for RHFA 8	28-9725	65

*customer supplied water source or other suitable kit required

UTILITY TRACTOR REAR MOUNT ANGLE SWEEPER - HYDRAULIC DRIVE (RLH)



- Drive slips easily out of core without removing hydraulic lines from wheel motor
- Brush core is reversible for even brush wear
- 32" diameter brush for longer life
- Angles manually 30° left/right
- Rear mount
- Sweep width 5' to 7'

Model	DM18		SM18		SM28		Width	Brush Diameter	Weight (Approx)
	GPM Range	PSI Range	GPM Range	PSI Range	GPM Range	PSI Range			
QC5	20-36	2000-3500	10-18	2000-3500	12-25	2000-3000	60"	32"	1090 lbs
QC6	20-36	2000-3500	10-18	2000-3500	12-25	2000-3000	72"	32"	1150 lbs
QC7	20-36	2000-3500	10-18	2000-3500	12-25	2000-3000	84"	32"	1210 lbs
QC8	20-36	2000-3500			12-25	2000-3000	96"	32"	1270 lbs
QC-9	20-36	2000-3500					108"	32"	1330 lbs

UTILITY TRACTOR REAR MOUNT ANGLE SWEEPER - HYDRAULIC DRIVE (RLH)



TO ORDER: CHOOSE BRUSH HEAD & BRUSH MATERIAL, ANGLE AND MOUNTING

BRUSH HEAD AND BRUSH MATERIAL	ORDER CODE	SHIP WEIGHT (LBS)
Brush Head with Single 18" Cubic Inch Motor (SM18) - 10-18 GPM, 2000-3500 PSI		
Hydraulic Drive Brush Head - All Polypropylene Brush		
QC 5 ft hydraulic drive brush head	QC32P5SM18	383
QC 6 ft hydraulic drive brush head	QC32P6SM18	442
QC 7 ft hydraulic drive brush head	QC32P7SM18	505
QC 8 ft hydraulic drive brush head	QC32P8SM18	572
Hydraulic Drive Brush Head - Polypropylene & Wire Brush		
QC 5 ft hydraulic drive brush head	QC32M5SM18	383
QC 6 ft hydraulic drive brush head	QC32M6SM18	442
QC 7 ft hydraulic drive brush head	QC32M7SM18	505
QC 8 ft hydraulic drive brush head	QC32M8SM18	572
Brush Head with Single 28" Cubic Inch Motor (SM28) - 12-25 GPM, 2000-3000 PSI		
Hydraulic Drive Brush Head - All Polypropylene Brush		
QC 5 ft hydraulic drive brush head	QC32P5SM28	383
QC 6 ft hydraulic drive brush head	QC32P6SM28	442
QC 7 ft hydraulic drive brush head	QC32P7SM28	505
QC 8 ft hydraulic drive brush head	QC32P8SM28	572
QC 9 ft hydraulic drive brush head	QC32P9SM28	639
Brush Head with Single 28" Cubic Inch Motor (SM28) - 12-25 GPM, 2000-3000 PSI cont.		
Hydraulic Drive Brush Head - Polypropylene & Wire Brush		
QC 5 ft hydraulic drive brush head	QC32M5SM28	383

BRUSH HEADS CONTINUED NEXT PAGE

SWEEPERS

UTILITY TRACTOR REAR MOUNT ANGLE SWEEPER - HYDRAULIC DRIVE (RLH) CONT.

BRUSH HEAD AND BRUSH MATERIAL CONT.	ORDER CODE	SHIP WEIGHT (LBS)
QC 6 ft hydraulic drive brush head	QC32M6SM28	442
QC 7 ft hydraulic drive brush head	QC32M7SM28	505
QC 8 ft hydraulic drive brush head	QC32M8SM28	572
QC 9 ft hydraulic drive brush head	QC32M9SM28	639
Brush Head with Dual 18" Cubic Inch Motor (DM18) - 20-36 GPM, 2000-3500 PSI		
Hydraulic Drive Brush Head - All Polypropylene Brush		
QC 5 ft hydraulic drive brush head	QC32P5DM18	383
QC 6 ft hydraulic drive brush head	QC32P6DM18	442
QC 7 ft hydraulic drive brush head	QC32P7DM18	505
QC 8 ft hydraulic drive brush head	QC32P8DM18	572
QC 9 ft hydraulic drive brush head	QC32P9DM18	639
Hydraulic Drive Brush Head - Polypropylene & Wire Brush		
QC 5 ft hydraulic drive brush head	QC32M5DM18	383
QC 6 ft hydraulic drive brush head	QC32M6DM18	442
QC 7 ft hydraulic drive brush head	QC32M7DM18	505
QC 8 ft hydraulic drive brush head	QC32M8DM18	572
QC 9 ft hydraulic drive brush head	QC32M9DM18	639
ANGLE (MANUAL OR HYDRAULIC)	ORDER CODE	SHIP WEIGHT (LBS)
manual angle link	13-3406	15
Hydraulic angle cylinder & 72" hoses - no valve	11-4298	30
REAR 3-POINT MOUNTING CAT I OR II (ONE REQUIRED)	ORDER CODE	SHIP WEIGHT (LBS)
with broom driven by tractor hydraulics (Cat I)	11-5031	425
with 20 gpm hydraulic system for use with S28 & DM18 hydraulic motors (CAT I)	11-4202	625
with 20 gpm hydraulic system for use with S28 & DM18 hydraulic motors (CAT II)	11-5064	625
with 24 gpm pump (CAT II) 1000 pto	11-5065	625
with boom driven by tractor hydraulics (Cat II)	11-5045	325
OPTIONS CONTINUED NEXT PAGE		

UTILITY TRACTOR REAR MOUNT ANGLE SWEEPER - HYDRAULIC DRIVE (RLH) CONT.

OPTIONS	ORDER CODE	SHIP WEIGHT (LBS)
steel dirt deflector	RHFADD	75
rubber dirt deflector flap for tractor side of brush head	28-9951	65
Sprinkler System (select both items below to complete kit)		
sprinkler system tank 25 gallon with mounting and shutoff - CAT I only	11-5739	75
sprinkler system no tank kit 12V for all lengths - field installed	28-9919*	25
sprinkler system pump, filter, nozzles 12V - factory installed	28-10114	25
180 Hood - Factory Installed		
for RLH 5	28-10311-5	50
for RLH 6	28-10311-6	55
for RLH 7	28-10311-7	60
for RLH 8	28-10311-8	65
180 Hood - Field Installed		
for RLH 5	28-10361-5	50
for RLH 6	28-10361-6	55
for RLH 7	28-10361-7	60
for RLH 8	28-10361-8	65
Drape Deflector Includes 180 Hood - Factory Installed		
for RLH 5	28-10312-5	65
for RLH 6	28-10312-6	70
for RLH 7	28-10312-7	75
for RLH 8	28-10312-8	80
Drape Deflector Includes 180 Hood - Field Installed		
for RLH 5	28-10362-5	65
for RLH 6	28-10362-6	70
for RLH 7	28-10362-7	75
for RLH 8	28-10362-8	80

*customer supplied water source or other suitable kit required

SWEEPERS

UTILITY TRACTOR ANGLE SWEEPER - PTO TO HYDRAULIC DRIVE (AH/CH)



- Drive slips easily out of core without removing hydraulic lines from wheel motor(s)
- Brush core is reversible for even brush wear
- 32" diameter brush for longer life
- Angles manually 30° left/right
- Front mount
- Sweep width for AH is 5' to 7', CH is 5' to 9'

Model	DM18		SM18		SM28		Width	Brush Diameter	Weight (Approx)
	GPM Range	PSI Range	GPM Range	PSI Range	GPM Range	PSI Range			
QC5	20-36	2000-3500	10-18	2000-3500	12-25	2000-3000	60"	32"	1090 lbs
QC6	20-36	2000-3500	10-18	2000-3500	12-25	2000-3000	72"	32"	1150 lbs
QC7	20-36	2000-3500	10-18	2000-3500	12-25	2000-3000	84"	32"	1210 lbs
QC8	20-36	2000-3500			12-25	2000-3000	96"	32"	1270 lbs
QC-9	20-36	2000-3500					108"	32"	1270 lbs

UTILITY TRACTOR ANGLE SWEEPER - PTO TO HYDRAULIC DRIVE (AH/CH)



TO ORDER: CHOOSE BRUSH HEAD & BRUSH MATERIAL, SWING ASSEMBLY, PUMP LOCATION AND MOUNTING

BRUSH HEAD AND BRUSH MATERIAL	ORDER CODE	SHIP WEIGHT (LBS)
BRUSH HEAD WITH SINGLE MOTOR - 10-18 GPM, 2000-3500 PSI		
Hydraulic Drive Brush Head - All Polypropylene Brush		
QC 5 ft hydraulic drive brush head	QC32P5SM18	383
QC 6 ft hydraulic drive brush head	QC32P6SM18	442
QC 7 ft hydraulic drive brush head	QC32P7SM18	505
QC 8 ft hydraulic drive brush head	QC32P8SM18	572
Hydraulic Drive Brush Head - Polypropylene & Wire Brush		
QC 5 ft hydraulic drive brush head	QC32M5SM18	383
QC 6 ft hydraulic drive brush head	QC32M6SM18	442
QC 7 ft hydraulic drive brush head	QC32M7SM18	505
QC 8 ft hydraulic drive brush head	QC32M8SM18	572

BRUSH HEAD AND BRUSH MATERIAL CONTINUED NEXT PAGE

UTILITY TRACTOR ANGLE SWEEPER - PTO TO HYDRAULIC DRIVE (AH/CH)

BRUSH HEAD AND BRUSH MATERIAL CONT.	ORDER CODE	SHIP WEIGHT (LBS)
BRUSH HEAD WITH SINGLE MOTOR - 12-25 GPM, 2000-3000 PSI		
Hydraulic Drive Brush Head - All Polypropylene Brush		
QC 5 ft hydraulic drive brush head	QC32P5SM28	383
QC 6 ft hydraulic drive brush head	QC32P6SM28	442
QC 7 ft hydraulic drive brush head	QC32P7SM28	505
QC 8 ft hydraulic drive brush head	QC32P8SM28	572
QC 9 ft hydraulic drive brush head	QC32P9SM28	639
BRUSH HEAD WITH SINGLE MOTOR - 12-25 GPM, 2000-3000 PSI		
Hydraulic Drive Brush Head - Polypropylene & Wire Brush		
QC 5 ft hydraulic drive brush head	QC32M5SM28	383
QC 6 ft hydraulic drive brush head	QC32M6SM28	442
QC 7 ft hydraulic drive brush head	QC32M7SM28	505
QC 8 ft hydraulic drive brush head	QC32M8SM28	572
QC 9 ft hydraulic drive brush head	QC32M9SM28	639
BRUSH HEAD WITH DUAL MOTOR - 20-36 GPM, 2000-3500 PSI		
Hydraulic Drive Brush Head - All Polypropylene Brush		
QC 5 ft hydraulic drive brush head	QC32P5DM18	383
QC 6 ft hydraulic drive brush head	QC32P6DM18	442
QC 7 ft hydraulic drive brush head	QC32P7DM18	505
QC 8 ft hydraulic drive brush head	QC32P8DM18	572
QC 9 ft hydraulic drive brush head	QC32P9DM18	639
Hydraulic Drive Brush Head - Polypropylene & Wire Brush		
QC 5 ft hydraulic drive brush head	QC32M5DM18	383
QC 6 ft hydraulic drive brush head	QC32M6DM18	442
QC 7 ft hydraulic drive brush head	QC32M7DM18	505
QC 8 ft hydraulic drive brush head	QC32M8DM18	572
QC 9 ft hydraulic drive brush head	QC32M9DM18	639
SWING ASSEMBLY (ONE REQUIRED)	ORDER CODE	SHIP WEIGHT (LBS)
Heavy Duty Plate Type Swing Recommended when sweeping at less than a 30 degree angle		
offsets brush to the side, brush is angled	28-4612	290
Scissor Type Swing		
brush stays centered on vehicle when angle 30 degrees left or right	11-0790	282
20 GPM PUMP LOCATION	ORDER CODE	SHIP WEIGHT (LBS)
Contact Customer Service for Mounting Availability		
rear PTO driven (standard)	RPD	n/a
MOUNTING (ONE REQUIRED)	ORDER CODE	SHIP WEIGHT (LBS)
Contact Customer Service for Mounting Availability		
Tractor Mounting Assembly with Hydraulic System - Pump, Tank & Valve Option		
with manual lift, swing and run valves (not available for cab tractors)	MV	468
with electric run valve for FPD mountings (lift & swing operated from tractor remotes)	RUV	468
with electric valves lift, swing and run valves	EV	468
with no valves Brush turned off with PTO (lift & swing operated from tractor remotes)	NV	468
MOUNTING CONTINUED NEXT PAGE		

SWEEPERS

UTILITY TRACTOR ANGLE SWEEPER - PTO TO HYDRAULIC DRIVE (AH/CH)

MOUNTING (ONE REQUIRED) CONT. Contact Customer Service for Mounting Availability		ORDER CODE	SHIP WEIGHT (LBS)
Tractor Mounting Assembly Operated from Tractor Hydraulic System, Valve Option Only			
with manual lift, swing and run valves (not available for cab tractors)		HMV	468
with electric run valve (lift and swing operated from tractor remotes)		HRUV	468
with electric valves lift, swing and run valves		HEV	468
with no valves (run lift and swing operated with tractor remotes)		HNV	468
OPTIONS		ORDER CODE	SHIP WEIGHT (LBS)
sight indicator flags		11-5897	10
sight indicators red balls		28-9965	10
bolt on stand kit front/rear		28-10315	60
Sprinkler System (select one system and tank to complete kit)			
sprinkler system fits all nozzles - mounts to hood, no tank 12V - field installed		28-9919*	25
sprinkler system pump, filter, nozzles 12V - factory installed		28-10114	25
sprinkler system tank 25 gallon with shut-off (no mount included - customer must make)		28-4319**	75
200 gallon 3-Point mounted water tank		11-5734	250
180 Hood - Factory Installed			
for QC-5		28-10311-5	50
for QC-6		28-10311-6	55
for QC-7		28-10311-7	60
for QC-8		28-10311-8	65
for QC-9		28-10311-9	70
180 Hood - Field Installed			
for QC-5		28-10361-5	50
for QC-6		28-10361-6	55
for QC-7		28-10361-7	60
for QC-8		28-10361-8	65
for QC-9		28-10361-9	70
Drape Deflector Includes 180 Hood - Factory Installed			
for QC-5		28-10312-5	65
for QC-6		28-10312-6	70
for QC-7		28-10312-7	75
for QC-8		28-10312-8	80
for QC-9		28-10312-9	85
Drape Deflector Includes 180 Hood - Field Installed			
for QC-5		28-10362-5	65
for QC-6		28-10362-6	70
for QC-7		28-10362-7	75
for QC-8		28-10362-8	80
for QC-9		28-10362-9	85

*customer supplied water source or other suitable kit required

**customer supplied mounting system required (do not mount directly to sweeper hood)

UTILITY TRACTOR LOADER ANGLE SWEEPER - HYDRAULIC DRIVE (QCTL)



- Drive slips out of core without removing hydraulic lines from wheel motor
- Brush core is reversible for even brush wear
- 32" diameter brush for longer life
- Angles manually 30° left/right
- Faceted hood design provides maximum strength at ends of the hood
- Choose poly or poly/wire brush

Specifications						
Model #	Width	Width @ 30°	Motors	Brush Diameter	Weight (approx.)	GPM Range
22059	60"	54"	single	32"	793	10-18
22060	60"	54"	single	32"	793	12-25
22061	60"	54"	dual	32"	829	18-36
22071	72"	64"	single	32"	852	10-18
22072	72"	64"	single	32"	852	12-25
22073	72"	64"	dual	32"	890	18-36
22083	84"	75"	single	32"	915	10-18
22084	84"	75"	single	32"	915	12-25
22085	84"	75"	dual	32"	953	18-36
22096	96"	85"	single	32"	982	12-25
22097	96"	85"	dual	32"	1,022	18-36

HOW TO ORDER YOUR SWEEPER



example: 22060P + M + 0913 = 22060PM-0913

UTILITY TRACTOR LOADER ANGLE SWEEPER - HYDRAULIC DRIVE (QCTL)



BRUSH HEAD AND BRUSH MATERIAL	ORDER CODE	SHIP WEIGHT (LBS)
BRUSH HEAD WITH SINGLE MOTOR - 10-18 GPM, 2000-3500 PSI		
Brush Head with Single Motor - All Polypropylene Brush		
QC 5 ft hydraulic drive brush head	22059P	793
QC 6 ft hydraulic drive brush head	22071P	852
QC 7 ft hydraulic drive brush head	22083P	915
Brush Head with Single Motor - Polypropylene & Wire Brush		
QC 5 ft hydraulic drive brush head	22059M	793
QC 6 ft hydraulic drive brush head	22071M	852
QC 7 ft hydraulic drive brush head	22083M	915

SWEEPERS

UTILITY TRACTOR LOADER ANGLE SWEEPER - HYDRAULIC DRIVE (QCTL) CONT.

BRUSH HEAD AND BRUSH MATERIAL	ORDER CODE	SHIP WEIGHT (LBS)
BRUSH HEAD WITH SINGLE MOTOR - 12-25 GPM, 2000-3000 PSI		
Brush Head with Single Motor - All Polypropylene Brush		
QC 5 ft hydraulic drive brush head	22060P	831
QC 6 ft hydraulic drive brush head	22072P	890
QC 7 ft hydraulic drive brush head	22084P	953
QC 8 ft hydraulic drive brush head	22096P	1020
Brush Head with Single Motor - Polypropylene & Wire Brush		
QC 5 ft hydraulic drive brush head	22060M	831
QC 6 ft hydraulic drive brush head	22072M	890
QC 7 ft hydraulic drive brush head	22084M	953
QC 8 ft hydraulic drive brush head	22096M	1020
BRUSH HEAD WITH DUAL MOTOR - 20-36 GPM, 2000-3500 PSI		
Brush Head with Dual Motor - All Polypropylene Brush		
QC 5 ft hydraulic drive brush head	22061P	831
QC 6 ft hydraulic drive brush head	22073P	890
QC 7 ft hydraulic drive brush head	22085P	953
QC 8 ft hydraulic drive brush head	22097P	1020
Brush Head with Dual Motor - Polypropylene & Wire Brush		
QC 5 ft hydraulic drive brush head	22061M	831
QC 6 ft hydraulic drive brush head	22073M	890
QC 7 ft hydraulic drive brush head	22085M	953
QC 8 ft hydraulic drive brush head	22097M	1020
ANGLE TYPE MANUAL OR HYDRAULIC (ONE REQUIRED)		
Contact Customer Service for Mounting Information on Specific Tractors		
manual angle change	M	n/a
hydraulic angle change with electric valve 12 volt	H	22
hydraulic angle change with electric valve 24 volt	H2	22
hydraulic angle change cylinder and 72" hoses	H3	10
hydraulic angle change cylinder and 144" hoses	H4	20
hydraulic angle change cylinder only - no hoses	H5	17
Bi-directional sweeping valve 12 volt	H6	22
Hydraulic Angle Control Options (one required)		
Control box w/ power lead	28-10754	5
5 ft of extra cable for H or H2	07-7155	2
MOUNTING (ONE REQUIRED)		
Contact Customer Service for Mounting Availability		
Standardized mounting with the exception of ACS, Balderson, CAT Fusion, Bobcat X-Change, JRB 420, and Volvo L150		
OPTIONS CONTINUED NEXT PAGE		

UTILITY TRACTOR LOADER ANGLE SWEEPER - HYDRAULIC DRIVE (QCTL) CONT.

OPTIONS	ORDER CODE	SHIP WEIGHT (LBS)
sight indicator flag	11-5897	10
sight indicator ball	28-9965	10
Independent Hydraulic System		
independent hydraulic system pump (rear PTO tank mount to 3-Point 20 GPM with pressure relief valve)	11-7691	150
quick coupler kit for 3-Point hydraulic system	28-10014	24
Sprinkler Kits (select system and tank to complete kit)		
pump filter nozzles sprinkler system fits all nozzles mounts to hood 12V - field installed	28-9919*	25
sprinkler system pump, filter, nozzles 12V - factory installed	28-10114	25
sprinkler system tank 25 gallon with shut-off	28-4319**	75
180 Hood - Factory Installed		
for QC-5	28-10311-5	50
for QC-6	28-10311-6	55
for QC-7	28-10311-7	60
for QC-8	28-10311-8	65
180 Hood - Field Installed		
for QC-5	28-10361-5	50
for QC-6	28-10361-6	55
for QC-7	28-10361-7	60
for QC-8	28-10361-8	65
Drape Deflector Includes 180 Hood - Factory Installed		
for QC-5	28-10312-5	65
for QC-6	28-10312-6	70
for QC-7	28-10312-7	75
for QC-8	28-10312-8	80
Drape Deflector Includes 180 Hood - Field Installed		
for QC-5	28-10362-5	65
for QC-6	28-10362-6	70
for QC-7	28-10362-7	75
for QC-8	28-10362-8	80

*customer supplied water source or other suitable kit required

**customer supplied mounting system required (do not mount directly to sweeper hood)

SWEEPERS

SSL COLLECTOR SWEEPER - HYDRAULIC DRIVE (SB HOPPER)



Standard duty pickup cleanup

- Direct-drive motor powered from loader hydraulics
- 10-25 GPM flow required (2,000-3,500 psi)
- 26" brush diameter
- 5', 6', 7' brush widths available
- Brush head reversible for "dust-panning" debris
- Dump bucket by lifting arms
- Quick change core

Specifications

Model #	Working Width	Overall Width	Weight (approx.)	Brush Diameter	Hopper Capacity	Min. Hydraulic Flow	Max. Hydraulic Flow	PSI Range
21559	60"	72.3"	808 lbs	26"	13.9 ft ³	15 GPM	25 GPM	2000-3000
21560	60"	72.3"	955 lbs	26"	13.9 ft ³	15 GPM	25 GPM	2000-3000
21571	72"	84.3"	916 lbs	26"	16.8 ft ³	15 GPM	25 GPM	2000-3500
21572	72"	84.3"	1063 lbs	26"	16.8 ft ³	15 GPM	25 GPM	2000-3500
21583	84"	96.3"	1033 lbs	26"	19.8 ft ³	15 GPM	25 GPM	2000-3500
21584	84"	96.3"	1183 lbs	26"	19.8 ft ³	15 GPM	25 GPM	2000-3500

SSL COLLECTOR SWEEPER-HYDRAULIC DRIVE (SB HOPPER)



BRUSH HEAD AND BRUSH MATERIAL	ORDER CODE	SHIP WEIGHT (LBS)
Brush Head - All Polypropylene Brush GPM Range 10-18		
SB Hopper 5 ft hydraulic drive brush head	21559P-0022	808
SB Hopper 6 ft hydraulic drive brush head	21571P-0022	916
SB Hopper 7 ft hydraulic drive brush head	21583P-0022	1033
Brush Head - Polypropylene & Wire Brush		
SB Hopper 5 ft hydraulic drive brush head	21559M-0022	808
SB Hopper 6 ft hydraulic drive brush head	21571M-0022	913
SB Hopper 7 ft hydraulic drive brush head	21583M-0022	1033
Brush Head - All Polypropylene Brush GPM Range 15-25		
SB Hopper 5 ft hydraulic drive brush head	21560P-0022	955
SB Hopper 6 ft hydraulic drive brush head	21572P-0022	1063
SB Hopper 7 ft hydraulic drive brush head	21584P-0022	1183
Brush Head - Polypropylene & Wire Brush		
SB Hopper 5 ft hydraulic drive brush head	21560M-0022	955
SB Hopper 6 ft hydraulic drive brush head	21572M-0022	1063
SB Hopper 7 ft hydraulic drive brush head	21584M-0022	1183

SSL COLLECTOR SWEEPER - HYDRAULIC DRIVE (SB HOPPER) CONT.

MOUNTING (ONE REQUIRED)	ORDER CODE	SHIP WEIGHT (LBS)
Contact Customer Service for Mounting Availability		
universal skid steer mounting SAE J2513	0022	n/a
OPTIONS	ORDER CODE	SHIP WEIGHT (LBS)
Sprinkler System		
sprinkler kit 25 gallon tank 12 volt - factory installed	28-10136	47
sprinkler kit 25 gallon tank 24 volt - factory installed	28-10137	47
sprinkler kit 50 gallon tank 12 volt - factory installed	28-11100	-
sprinkler kit 50 gallon tank 24 volt - factory installed	28-11101	-
sprinkler kit 25 gallon tank 12 volt - field installed	28-9139	47
sprinkler kit 25 gallon tank 24 volt - field installed	28-9193	47
sprinkler kit 50 gallon tank 12 volt - field installed	28-11098	-
sprinkler kit 50 gallon tank 24 volt - field installed	28-11099	-
Gutter Broom Kits		
gutter broom kit poly brush - factory installed	28-10323-P	89
gutter broom kit wire brush - factory installed	28-10323-W	95
gutter broom shut off kit - factory installed	11-5449	20
gutter brush kit poly brush - field installed	28-10327-P	89
gutter brush kit wire brush - field installed	28-10327-W	95
gutter brush shut off kit - field installed	11-5449	20

SSL PICKUP SWEEPER - HYDRAULIC DRIVE HEAVY-DUTY (SB HOPPER)



- Direct-drive motor powered from loader hydraulics
- 10-25 GPM flow required (2000-3500 psi)
- 26" brush diameter
- 5', 6', 7' brush widths available
- Brush head reversible for "dust panning" debris
- Dump bucket by lifting arms
- Quick change core

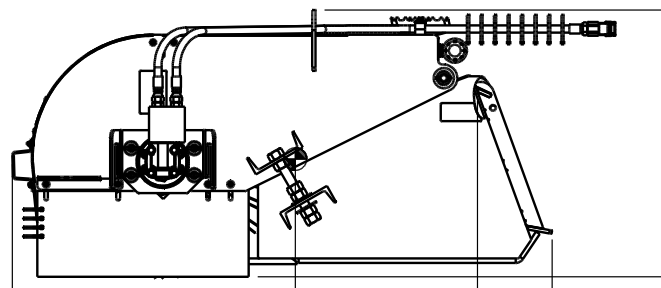

SWEEPERS

SSL PICKUP SWEEPER - HYDRAULIC DRIVE HEAVY-DUTY (SB HOPPER) CONT.



Specifications								
Model #	Working Width	Overall Width	Weight (approx.)	Brush Diameter	Hopper Capacity	Min. Hydraulic Flow	Max. Hydraulic Flow	PSI Range
21571-0022HD	72"	78"	1060 lbs	26"	16.8 ft ³	10 GPM	14 GPM	2000-3500
21572-0022HD	72"	78"	1060 lbs	26"	16.8 ft ³	18 GPM	25 GPM	2000-3500
21584-0022HD	84"	96.4"	1350 lbs	26"	19.8 ft ³	15 GPM	25 GPM	2000-3500

SSL PICKUP SWEEPER - HYDRAULIC DRIVE HEAVY-DUTY (SB HOPPER)



**TO ORDER: CHOOSE BRUSH HEAD & BRUSH MATERIAL
INCLUDES: BRUSH HEAD & BRUSH MATERIAL AND UNIVERSAL SSL MOUNTING**

BRUSH HEAD AND BRUSH MATERIAL	ORDER CODE	SHIP WEIGHT (LBS)
Brush Head - All Polypropylene Brush GPM Range 10-18		
SB Hopper 6 ft hydraulic drive brush head	21571P-0022HD	916
Brush Head - Polypropylene & Wire Brush		
SB Hopper 6 ft hydraulic drive brush head	21571M-0022HD	916
Brush Head - All Polypropylene Brush GPM Range 15-25		
SB Hopper 6 ft hydraulic drive brush head	21572P-0022HD	1063
SB Hopper 7 ft hydraulic drive brush head	21584P-0022HD	1334
Brush Head - Polypropylene & Wire Brush		
SB Hopper 6 ft hydraulic drive brush head	21572M-0022HD	1063
SB Hopper 7 ft hydraulic drive brush head	21584M-0022HD	1334

MOUNTING (ONE REQUIRED)	ORDER CODE	SHIP WEIGHT (LBS)
Contact Customer Service for Mounting Availability		
heavy duty bucket option	-0022HD	varies

OPTIONS	ORDER CODE	SHIP WEIGHT (LBS)
Sprinkler System - Factory Installed		
sprinkler kit 25 gallon tank 12 volt	28-10136	47
sprinkler kit 25 gallon tank 24 volt	28-10137	47
Sprinkler System - Field Installed		
sprinkler kit 25 gallon tank 12 volt	28-9139	47
sprinkler kit 25 gallon tank 24 volt	28-9193	47
Gutter Broom Kits - Factory Installed		
gutter broom kit poly brush	28-10323-P	89
gutter broom kit wire brush	28-10323-W	95
Gutter Broom Kits - Field Installed		
gutter broom kit poly brush	28-10327-P	89
gutter broom kit wire brush	28-10327-W	95
Replacement Parts		
0.63" x 6.0" edge for 60" bucket (11.25" bolt spacing)	28-10722-5	65
0.63" x 6.0" edge for 72" bucket (11.25" bolt spacing)	28-10722-6	77
0.63" x 6.0" edge for 84" bucket (11.25" bolt spacing)	28-10722-7	90

SSL COLLECTOR SWEEPER-HYDRAULIC DRIVE COLD PLANER SPECIAL (SB HOPPER)

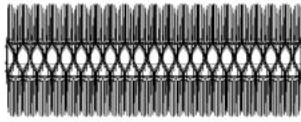

Standard 215 Core



Cold Planer Special

Cold Planer Special Option

- Designed to clean up millings after cold planer operations
- Brush is operated in reverse to collect millings in bucket
- Brush sections are compacted dense-filled wafers optimized for clearing the millings

Specifications								
Model #	Working Width	Overall Width	Weight (approx.)	Brush Diameter	Heaped Capacity	Min. Hydraulic Flow	Max. Hydraulic Flow	PSI Range
21560P	60"	66"	955 lbs	26"	13.9 ft ³	15 GPM	25 GPM	2000-3000
21572P	72"	78"	1063 lbs	26"	16.8 ft ³	15 GPM	25 GPM	2000-3500
21584P	84"	90"	1183 lbs	26"	19.8 ft ³	15 GPM	25 GPM	2000-3500

SSL COLLECTOR SWEEPER-HYDRAULIC DRIVE COLD PLANER SPECIAL (SB HOPPER)



TO ORDER: CHOOSE BRUSH HEAD & BRUSH MATERIAL, INCHES OF COMPACTED BRUSHES AND MOUNTING INCLUDES: BRUSH HEAD & BRUSH MATERIAL AND UNIVERSAL SSL MOUNTING

BRUSH HEAD AND BRUSH MATERIAL	ORDER CODE	SHIP WEIGHT (LBS)
Brush Head - All Polypropylene Brush GPM Range 15-25		
SB Hopper 5 ft hydraulic drive brush head	21560P	955
SB Hopper 6 ft hydraulic drive brush head	21572P	1063
SB Hopper 7 ft hydraulic drive brush head	21584P	1183
COLD PLANER SPECIAL SWEEPERS - USE AFTER MILLING, HEAVIER DESIGN WITH CENTER BRUSHES DENSELY PACKED		
Inches of Densely-Packed Center Brushes		
16" - 36" (16", 18", 24", 30", 36")	specify inches	
>36" (40", 48", 60", 72", 84")	specify inches	
MOUNTING (ONE REQUIRED)	ORDER CODE	SHIP WEIGHT (LBS)
Contact Customer Service for Mounting Availability		
universal skid steer mounting SAE J2513	0022	n/a
OPTIONS	ORDER CODE	SHIP WEIGHT (LBS)
Sprinkler System		
sprinkler kit 25 gallon tank 12 volt - factory installed	28-10136	47
sprinkler kit 25 gallon tank 24 volt - factory installed	28-10137	47
sprinkler kit 50 gallon tank 12 volt - factory installed	28-11100	-
sprinkler kit 50 gallon tank 24 volt - factory installed	28-11101	-
sprinkler kit 25 gallon tank 12 volt - field installed	28-9139	47
sprinkler kit 25 gallon tank 24 volt - field installed	28-9193	47
sprinkler kit 50 gallon tank 12 volt - field installed	28-11098	-
sprinkler kit 50 gallon tank 24 volt - field installed	28-11099	-
Gutter Broom Kits		
gutter broom kit poly brush - factory installed	28-10323-P	89
gutter broom kit wire brush - factory installed	28-10323-W	95
gutter broom kit poly brush - field installed	28-10327-P	89
gutter broom kit wire brush - field installed	28-10327-W	95
gutter broom shut off kit - field installed	11-5449	20

SWEEPERS

SSL COLLECTOR SWEEPER - HYDRAULIC DRIVE (VRS)



- Exclusive Volumizer™ feature increases bucket capacity 22%
- High dump design holds sweeper head clear of dumping bucket
- Quick change brush without breaking hydraulic lines
- Hydraulic motor can be removed for brush change without tools

Specifications								
Model #	Sweeping Width	Overall Width	Overall Length	Weight (approx.)	Hopper Capacity	GPM Range	PSI Range	Brush Diameter
VRS5	60"	76"	72.5"	1235 lbs	15 ft ³	15-25	2000-3000	26"
VRS6	72"	88"	72.5"	1351 lbs	18 ft ³	15-25	2000-3000	26"
VRS7	84"	100"	72.5"	1467 lbs	21 ft ³	15-25	2000-3000	26"

SSL COLLECTOR SWEEPER - HYDRAULIC DRIVE (VRS)



**TO ORDER: CHOOSE BRUSH HEAD & BRUSH MATERIAL AND MOUNTING
INCLUDES: BRUSH HEAD & BRUSH MATERIAL AND UNIVERSAL SSL MOUNTING**

BRUSH HEAD AND BRUSH MATERIAL	ORDER CODE	SHIP WEIGHT (LBS)
Hydraulic Drive Brush Head - All Polypropylene Brush		
VRS 5 ft hydraulic drive brush head	VRS5P	1235
VRS 6 ft hydraulic drive brush head	VRS6P	1351
VRS 7 ft hydraulic drive brush head	VRS7P	1467
Hydraulic Drive Brush Head - Polypropylene and Wire Brush		
VRS 5 ft hydraulic drive brush head	VRS5M	1235
VRS 6 ft hydraulic drive brush head	VRS6M	1351
VRS 7 ft hydraulic drive brush head	VRS7M	1467
MOUNTING (ONE REQUIRED)		
Contact Customer Service for Additional Mounting Availability		
universal skid steer mounting SAE J2513	0022	n/a



NOTE: Some skid steer loaders require special brackets supplied by the OEM manufacturer to attach the chains for the high dump feature. Check with the skid steer dealer for information on brackets required.

OPTIONS	ORDER CODE	SHIP WEIGHT (LBS)
sprinkler kit without tank	28-9140	31
Sprinkler System		
sprinkler kit 25 gallon tank 12 volt - factory installed	28-10136	47
sprinkler kit 25 gallon tank 24 volt - factory installed	28-10137	47
sprinkler kit 50 gallon tank 12 volt - factory installed	28-11100	-
sprinkler kit 50 gallon tank 24 volt - factory installed	28-11101	-
sprinkler kit 25 gallon tank 12 volt - field installed	28-9139	47
sprinkler kit 25 gallon tank 24 volt - field installed	28-9193	47
sprinkler kit 50 gallon tank 12 volt - field installed	28-11098	-
sprinkler kit 50 gallon tank 24 volt - field installed	28-11099	-

OPTIONS CONTINUED NEXT PAGE

SSL COLLECTOR SWEEPER - HYDRAULIC DRIVE (VRS) CONT.

OPTIONS CONT.	ORDER CODE	SHIP WEIGHT (LBS)
Gutter Broom Assembly		
gutter broom assembly poly - factory installed	28-10323-P	90
gutter broom assembly wire - factory installed	28-10323-W	90
dual gutter broom assembly poly - factory installed	28-10324-P	180
dual gutter broom assembly wire - factory installed	28-10324-W	180
gutter brush shut off kit - factory installed	11-5449	20
gutter broom assembly poly - field installed	28-10327-P	90
gutter broom assembly wire - field installed	28-10327-W	90

SSL COLLECTOR SWEEPER WITH WATERLESS DUST ABATEMENT - HYDRAULIC DRIVE (VS)



- Patented waterless dust abatement
- Volumizer® Bar increases bucket capacity 22%
- High dump feature
- Heavy duty cleanup
- Brush automatically follows ground contour
- Powered from SSL hydraulics
- 15-25 GPM flow required
- 26" brush diameter
- 5', 6', 7' brush widths available
- Quick change core
- Tool-less brush adjustment



Motor and Fan Unit



Filter Unit

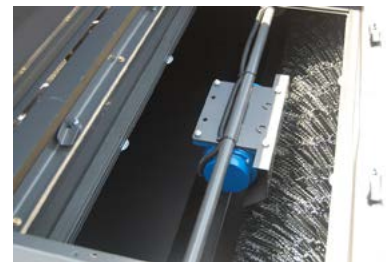

Shaker

Specifications										
Model #	Sweeping Width	Sweeping Width w/ Optional Gutter Brush	Overall Width	Overall Length	Overall Height	Weight (approx.)	Hopper Capacity	GPM Range	PSI Range	Maximum Back Pressure
VSS5	60"	72"	70.5"	69"	30"	1446 lbs	15 ft ³	15-25	2000-3000	
VSS6	72"	84"	82.5"	69"	30"	1562 lbs	18 ft ³	15-25	2000-3000	
VSS7	84"	96"	94.5"	69"	30"	1678 lbs	21 ft ³	15-25	2000-3000	
Waterless Dust Abatement Attachment			59"	26.5"	6.5"	235 lbs				350 PSI

VS CONTINUED NEXT PAGE

SWEEPERS

SSL COLLECTOR SWEEPER WITH WATERLESS DUST ABATEMENT - HYDRAULIC DRIVE (VS) CONT.



TO ORDER: CHOOSE BRUSH HEAD & BRUSH MATERIAL, MOUNTING AND FILTER SHAKER CONTROL SWITCH INCLUDES: BRUSH HEAD & BRUSH MATERIAL AND UNIVERSAL SSL MOUNTING

BRUSH HEAD AND BRUSH MATERIAL	ORDER CODE	SHIP WEIGHT (LBS)
Hydraulic Drive Brush Head - All Polypropylene Brush		
5 ft hydraulic drive brush head	VSS5P	1446
6 ft hydraulic drive brush head	VSS6P	1562
7 ft hydraulic drive brush head	VSS7P	1678
Hydraulic Drive Brush Head - Polypropylene and Wire Brush		
5 ft hydraulic drive brush head	VSS5M	1446
6 ft hydraulic drive brush head	VSS6M	1562
7 ft hydraulic drive brush head	VSS7M	1678
MOUNTING (ONE REQUIRED)	ORDER CODE	SHIP WEIGHT (LBS)
Contact Customer Service for Additional Mounting Availability		
universal skid steer mounting SAE J2513	0022	n/a



NOTE: Some skid steer loaders require special brackets supplied by the OEM manufacturer to attach the chains for the high dump feature. Check with the skid steer dealer for information on brackets required.

FILTER SHAKER CONTROL SWITCH (ONE REQUIRED)	ORDER CODE	SHIP WEIGHT (LBS)
Control box w/ power lead	28-10754	5
Wire Harness (multi function in cab controls) for CNH, JCB, Bobcat, Mustang, Kubota, Takeuchi, Volvo 14 Pin-8 Pin	LAF9360-0000	5
Wire harness for CNH (8-pin rectangular)	LAF9393	5
control wire harness for Komatsu 8 pin	07-10057	5
Wire harness for CAT pre-B (8-pin Deutsch)	07-10021	5
control wire harness for John Deere 14 pin	07-9437	5
5 ft of extra cable	07-7155	2
OPTIONS	ORDER CODE	SHIP WEIGHT (LBS)
<i>Note: Vacuum should not be used when operating gutter broom(s)</i>		
replacement vacuum filter	07-6679	n/a
Gutter Broom Assembly - Factory Installed		
gutter broom assembly poly	28-10323-P	90
gutter broom assembly wire	28-10323-W	90
dual gutter broom assembly poly	28-10324-P	180
dual gutter broom assembly wire	28-10324-W	180
Gutter Broom Assembly - Field Installed		
gutter broom assembly poly	28-10327-P	90
gutter broom assembly wire	28-10327-W	90

UTILITY TRACTOR LOADER COLLECTOR SWEEPER - HYDRAULIC DRIVE (CS)



- Heavy duty cleanup, millings, snow removal
- High dump feature activated by reversing flow
- Hopper positioned in front
- Powered from loader hydraulics
- 15-50 GPM flow required
- 26" and 32" brush diameter
- 6', 7', 8', 9' brush widths available
- Quick attach and pin-on mounts available
- Quick change core

Specifications									
Model	Sweeping Width	Overall Width	Overall Length (w/o quick coupler)	Weight (Approx)	Brush Diameter	Hopper Capacity	Horizontal CG (Broom Lifted)	GPM Range	PSI Range
20372*	72"	93"	75.25"	1000 lbs	26"	.4 yd ³	24.5"	15-25	2000-3500
20373*	72"	93"	75.25"	1030 lbs	26"	.4 yd ³	24.5"	26-50	2000-3500
20384	84"	105"	75.25"	1220 lbs	26"	.53 yd ³	25.5"	15-25	2000-3500
20385	84"	105"	75.25"	1250 lbs	26"	.53 yd ³	25.5"	26-50	2000-3500
20396	96"	117"	75.25"	1440 lbs	26"	.61 yd ³	26.5"	15-25	2000-3500
20397	96"	117"	75.25"	1470 lbs	26"	.61 yd ³	26.5"	26-50	2000-3500
20497	96"	117"	80.25"	1735 lbs	32"	.94 yd ³	30.0"	26-50	2000-3500
20409	108"	129"	80.25"	1948 lbs	32"	1.02 yd ³	30.0"	26-50	2000-3500

* 6 ft sweepers require minimum 2500 lb lift capacity

UTILITY TRACTOR LOADER COLLECTOR SWEEPER - HYDRAULIC DRIVE (CS)



TO ORDER: CHOOSE BRUSH HEAD & BRUSH MATERIAL, MOUNTING, AND HOSE KIT



NOTE: 6 ft sweepers require minimum 2500 lb lift capacity; 7-9 ft sweepers are not available for Skid-Steers; Hoses from sweeper to the loader are not supplied; Hose quick couplers are not supplied.

BRUSH HEAD AND BRUSH MATERIAL			ORDER CODE	SHIP WEIGHT (LBS)
26" DIAMETER BRUSH HEAD				
26" Diameter Brush Heads - All Polypropylene Brush - Single Motor		Overall Width	Hopper Capacity	GPM Range 15-25
CS26 6 ft hydraulic bucket sweeper brush head		93"	0.4 yd ³	20372P
CS26 7 ft hydraulic bucket sweeper brush head		105"	0.53 yd ³	20384P
CS26 8 ft hydraulic bucket sweeper brush head		117"	0.61 yd ³	20396P

BRUSH HEADS CONTINUED NEXT PAGE

SWEEPERS

UTILITY TRACTOR LOADER COLLECTOR SWEEPER - HYDRAULIC DRIVE (CS) CONT.

SWEEPERS

BRUSH HEAD AND BRUSH MATERIAL CONT.			ORDER CODE	SHIP WEIGHT (LBS)
26" DIAMETER BRUSH HEAD CONT.				
26" Diameter Brush Heads - Polypropylene & Wire Brush - Single Motor				
CS26 6 ft hydraulic bucket sweeper brush head	93"	0.4 yd ³	20372M	1383
CS26 7 ft hydraulic bucket sweeper brush head	105"	0.53 yd ³	20384M	1478
CS26 8 ft hydraulic bucket sweeper brush head	117"	0.61 yd ³	20396M	1573
26" Diameter Brush Heads - All Polypropylene Brush - Dual Motor		Overall Width	Hopper Capacity	GPM Range 26-50
CS26 6 ft hydraulic bucket sweeper brush head	93"	0.4 yd ³	20373P	1418
CS26 7 ft hydraulic bucket sweeper brush head	105"	0.53 yd ³	20385P	1513
CS26 8 ft hydraulic bucket sweeper brush head	117"	0.61 yd ³	20397P	1608
26" Diameter Brush Heads - Polypropylene & Wire Brush - Dual Motor				
CS26 6 ft hydraulic bucket sweeper brush head	93"	0.4 yd ³	20373M	1418
CS26 7 ft hydraulic bucket sweeper brush head	105"	0.53 yd ³	20385M	1513
CS26 8 ft hydraulic bucket sweeper brush head	117"	0.61 yd ³	20397M	1608
32" DIAMETER BRUSH HEAD				
32" Diameter Brush Heads - All Polypropylene Brush - Dual Motor		Overall Width	Hopper Capacity	GPM Range 26-50
CS32 8 ft hydraulic bucket sweeper brush head	117"	0.94 yd ³	20497P	1837
CS32 9 ft hydraulic bucket sweeper brush head	129"	1.02 yd ³	20409P	1948
32" Diameter Brush Heads - Polypropylene & Wire Brush - Dual Motor				
CS32 8 ft hydraulic bucket sweeper brush head	117"	0.94 yd ³	20497M	1837
CS32 9 ft hydraulic bucket sweeper brush head	129"	1.02 yd ³	20409M	1948

MOUNTING (ONE REQUIRED)		ORDER CODE	SHIP WEIGHT (LBS)
Contact Customer Service for Mounting Availability			
various quick-attaches		varies	125
Standardized mounting with the exception of ACS, CAT Fusion and Bobcat X-Change			

OPTIONS		ORDER CODE	SHIP WEIGHT (LBS)
Hose Kits - Hose quick couplers are not supplied.			
3 ft CS hose kit .75" hoses FFS hose ends		28-10148-3	20
6 ft CS hose kit .75" hoses FFS hose ends		28-10148-6	23
9 ft CS hose kit .75" hoses FFS hose ends		28-10148-9	26
12 ft CS hose kit .75" hoses FFS hose ends		28-10148-12	29
Sprinkler Kit - Without Tank - Factory Installed			
sprinkler kit no tank includes pump, filter, nozzles, 12 volt		28-10114	30
sprinkler kit no tank includes pump, filter, nozzles, 24 volt		28-10115	30

OPTIONS CONTINUED NEXT PAGE

UTILITY TRACTOR LOADER COLLECTOR SWEEPER - HYDRAULIC DRIVE (CS) CONT.

OPTIONS CONT.	ORDER CODE	SHIP WEIGHT (LBS)
Sprinkler Kit - Without Tank - Field Installed		
sprinkler kit no tank includes pump, filter, nozzles, 12 volt	28-9919*	30
sprinkler kit no tank includes pump, filter, nozzles, 24 volt	28-10116	30
Sprinkler Kit - With Tank - Factory Installed		
sprinkler kit includes 85 gallon tank 12 volt (only available for use with CS32)	28-10153	130
sprinkler kit includes 85 gallon tank 24 volt (only available for use with CS32)	28-10156	130
Sprinkler Kit - With Tank - Field Installed		
sprinkler kit includes 25 gallon tank 12 volt	28-9139	47
sprinkler kit includes 25 gallon tank 24 volt	28-9193	47
Gutter Broom Assembly - Factory Installed		
gutter broom single assembly poly	28-10118	90
gutter broom dual assembly poly	28-10120	180
gutter broom single assembly wire	28-10117	90
gutter broom dual assembly wire	28-10119	180

*customer supplied water source or other suitable kit required

UTILITY TRACTOR LOADER COLLECTOR SWEEPER WITH WATERLESS DUST ABATEMENT - HYDRAULIC DRIVE (VCS)



US PATENT NO: 7,928,596

- Patented waterless dust abatement
- Heavy duty cleanup
- High dump feature activated by reversing flow
- Hopper positioned in front
- Powered from loader hydraulics
- 15-50 GPM flow required
- 26" and 32" brush diameter
- 6', 7', 8', 9' brush widths available
- Quick attach mount
- Quick change core

Specifications							
Model	Sweeping Width	Overall Width	Weight (Approx)	Brush Diameter	Hopper Capacity	GPM Range	PSI Range
20374*	72"	93"	1100 lbs	26"	.4 yd ³	15-25	2000-3500
20375*	72"	93"	1130 lbs	26"	.4 yd ³	26-50	2000-3500
20386	84"	105"	1320 lbs	26"	.53 yd ³	15-25	2000-3500
20387	84"	105"	1350 lbs	26"	.53 yd ³	26-50	2000-3500
20398	96"	117"	1540 lbs	26"	.61 yd ³	15-25	2000-3500
20399	96"	117"	1570 lbs	26"	.61 yd ³	26-50	2000-3500
20499	96"	117"	1835 lbs	32"	.91 yd ³	26-50	2000-3500
20411	108"	129"	2048 lbs	32"	1.02 yd ³	26-50	2000-3500

* 6 ft sweepers require minimum 2500 lb lift capacity

VCS CONTINUED NEXT PAGE

SWEEPERS

UTILITY TRACTOR LOADER COLLECTOR SWEEPER WITH WATERLESS DUST ABATEMENT - HYDRAULIC DRIVE (VCS) CONT.



TO ORDER: CHOOSE BRUSH HEAD & BRUSH MATERIAL, FILTER SHAKER CONTROL ASSEMBLY AND MOUNTING



NOTE: 6 ft sweepers require minimum 2500 lb lift capacity; 7-9 ft sweepers are not available for Skid-Steers; Hoses from sweeper to the loader are not supplied; Hose quick couplers are not supplied.

BRUSH HEAD AND BRUSH MATERIAL		ORDER CODE	SHIP WEIGHT (LBS)
26" DIAMETER BRUSH HEAD			
26" Diameter Brush Heads - All Polypropylene Brush - Single Motor	Overall Width	Hopper Capacity	GPM Range 15-25
VCS26 6 ft hydraulic bucket sweeper brush head *	93"	0.4 yd ³	20374SP 1623
VCS26 7 ft hydraulic bucket sweeper brush head	105"	0.53 yd ³	20386SP 1718
VCS26 8 ft hydraulic bucket sweeper brush head	117"	0.61 yd ³	20398SP 1813
26" Diameter Brush Heads - Polypropylene & Wire Brush - Single Motor			
VCS26 6 ft hydraulic bucket sweeper brush head *	93"	0.4 yd ³	20374SM 1623
VCS26 7 ft hydraulic bucket sweeper brush head	105"	0.53 yd ³	20386SM 1718
VCS26 8 ft hydraulic bucket sweeper brush head	117"	0.61 yd ³	20398SM 1813
26" Diameter Brush Heads - All Polypropylene Brush - Dual Motor	Overall Width	Hopper Capacity	GPM Range 26-50
VCS26 6 ft hydraulic bucket sweeper brush head *	93"	0.4 yd ³	20375SP 1658
VCS26 7 ft hydraulic bucket sweeper brush head	105"	0.53 yd ³	20387SP 1753
VCS26 8 ft hydraulic bucket sweeper brush head	117"	0.61 yd ³	20399SP 1848
26" Diameter Brush Heads - Polypropylene & Wire Brush - Dual Motor			
VCS26 6 ft hydraulic bucket sweeper brush head *	93"	0.4 yd ³	20375SM 1658
VCS26 7 ft hydraulic bucket sweeper brush head	105"	0.53 yd ³	20387SM 1753
VCS26 8 ft hydraulic bucket sweeper brush head	117"	0.61 yd ³	20399SM 1848
32" DIAMETER BRUSH HEAD			
32" Diameter Brush Heads - All Polypropylene Brush - Dual Motor	Overall Width	Hopper Capacity	GPM Range 26-50
VCS32 8 ft hydraulic bucket sweeper brush head	117"	0.94 yd ³	20411SP 2153
VCS32 9 ft hydraulic bucket sweeper brush head	129"	1.02 yd ³	20411SP 2287
32" Diameter Brush Heads - Polypropylene & Wire Brush - Dual Motor			
VCS32 8 ft hydraulic bucket sweeper brush head	117"	0.94 yd ³	20499SM 2153
VCS32 9 ft hydraulic bucket sweeper brush head	129"	1.02 yd ³	20411SM 2287

FILTER SHAKER CONTROL ASSEMBLY (ONE REQUIRED)	ORDER CODE	SHIP WEIGHT (LBS)
12 VDC Filter Shaker Assembly (Standard configuration)	H	n/a
24 VDC Filter Shaker Assembly (Select only if 24 VDC is required)	H2	n/a

MOUNTING (ONE REQUIRED)	ORDER CODE	SHIP WEIGHT (LBS)
Contact Customer Service for Mounting Availability		
various quick-attaches	varies	125
Standardized mounting with the exception of ACS, CAT Fusion and Bobcat X-Change		

VCS CONTINUED NEXT PAGE

UTILITY TRACTOR LOADER COLLECTOR SWEEPER WITH WATERLESS DUST ABATEMENT - HYDRAULIC DRIVE (VCS) CONT.

OPTIONS	ORDER CODE	SHIP WEIGHT (LBS)
replacement vacuum filter	07-6679	n/a
Hose Kits - Hoses from the sweeper to the loader are not supplied. Hose packages available are listed below or the dealer can make up their own hoses. Hose quick couplers are not supplied.		
3 ft CS hose kit .75" hoses FFS hose ends	28-10148-3	20
6 ft CS hose kit .75" hoses FFS hose ends	28-10148-6	23
9 ft CS hose kit .75" hoses FFS hose ends	28-10148-9	26
12 ft CS hose kit .75" hoses FFS hose ends	28-10148-12	29
Gutter Broom Assembly - Factory Installed		
gutter broom single assembly poly	28-10118	90
gutter broom dual assembly poly	28-10120	180
gutter broom single assembly wire	28-10117	90
gutter broom dual assembly wire	28-10119	180

SWEEPERS

REPLACEMENT BRUSHES

Palletization is Available on Brush Prices.
Contact Sweepster for Additional Cost.



Poly



Wire



Poly/Wire



SWEEPERS

MECHANICAL DRIVE ANGLE SWEEPERS

				Individual Section		Packs (qty of 24/25)		Complete Set		
Model Description	Model Name / Series	Brush Head / Order Code	Section Size (IDxOD)	Poly	Mixed (Poly / Wire)	Poly	Mixed (Poly / Wire)	Poly	Set Qty	Mixed (Poly / Wire)
Commercial Turf Mower Angle Sweeper Mechanical Drive	CTM	M24P4A	6.38x24	01-5009C		01-5009C-25		01-0001C	24	
		M24P5A						01-0017C	31	
		M24P6A						01-0537C	38	
		M24C4A		01-5009C	01-0015C (wire only)	01-5009C-25	01-0015C-24		13P/11W	01-0013C
		M24C5A							16P/15W	01-0019C
		M24C6A							20P/18W	01-0539C
Compact Tractor Angle Sweeper Mechanical Drive PTO	RMRM	M24P4A	6.38x24	01-5009C		01-5009C-25		01-0001C	24	
		M24P5A						01-0017C	31	
		M24P6A						01-0537C	38	
		M24C4A		01-5009C	01-0015C (wire only)	01-5009C-25	01-0015C-24		13P/11W	01-0013C
		M24C5A							16P/15W	01-0019C
		M24C6A							20P/18W	01-0539C
Utility Tractor Rear Mount Angle Sweeper Mechanical Drive PTO	RHFA	RHFA5	10x32	01-5002C	01-5878	01-5002C-25	01-5878-24	01-1210-5	29	01-1209-5
		RHFA6						01-1210-6	35	01-1209-6
		RHFA7						01-1210-7	41	01-1209-7
		RHFA8						01-1210-8	47	01-1209-8

HYDRAULIC DRIVE ANGLE SWEEPERS

				Individual Section		Packs (qty of 24/25)		Complete Set			
Model Description	Model Name / Series	Brush Head / Order Code	Section Size (IDxOD)	Poly	Mixed (Poly / Wire)	Poly	Mixed (Poly / Wire)	Poly	Set Qty	Mixed (Poly / Wire)	
Commercial Turf Mower Angle Sweeper Hydraulic Drive	CTH	S26-4	8x26	01-5210	01-5010	01-5210-25	01-5010-24	01-0872	26	01-1158	
		S26-5						01-1161	35	01-1167	
		S26-6						01-1162	41	01-1168	
Compact Tractor Loader Angle Sweeper Hydraulic Drive	MRHL	S26-4	8x26	01-5210	01-5010	01-5210-25	01-5010-24	01-0872	26	01-1158	
		S26-5						01-1161	35	01-1167	
		S26-6						01-1162	41	01-1168	
		S30-4	8x30	01-5011	01-5012						
		S30-5									
		S30-6									
		S30-7									

REPLACEMENT BRUSHES CONTINUED NEXT PAGE

REPLACEMENT BRUSHES CONT.

HYDRAULIC DRIVE ANGLE SWEEPERS												
Model Description	Model Name / Series	Brush Head / Order Code	Section Size (IDxOD)	Individual Section		Packs (qty of 24/25)		Complete Set				
				Poly	Mixed (Poly / Wire)	Poly	Mixed (Poly / Wire)	Poly	Set Qty	Mixed (Poly / Wire)		
Compact Tractor Angle Sweeper Hydraulic Drive	MRH	S26-4	8x26	01-5210	01-5010	01-5210-25	01-5010-24	01-0872	26	01-1158		
		S26-5						01-1161	35	01-1167		
		S26-6						01-1162	41	01-1168		
				S30-4	8x30	01-5011	01-5012					
				S30-5								
				S30-6								
				S30-7								
SSL Angle Sweeper Hydraulic Drive	QCSS / 220	QC5	10x32	01-5002C	01-5878	01-5002C-25	01-5878-24	01-1210-5	29	01-1209-5		
		QC6						01-1210-6	35	01-1209-6		
		QC7						01-1210-7	41	01-1209-7		
		QC8						01-1210-8	47	01-1209-8		
Utility Tractor Rear Mount Angle Sweeper Hydraulic Drive PTO	RLH	QC5	10x32	01-5002C	01-5878	01-5002C-25	01-5878-24	01-1210-5	29	01-1209-5		
		QC6						01-1210-6	35	01-1209-6		
		QC7						01-1210-7	41	01-1209-7		
		QC8						01-1210-8	47	01-1209-8		
		QC9						01-1210-9	53	01-1209-9		
Utility Tractor Loader Angle Sweeper Hydraulic Drive	QCTL / 220	QC5	10x32	01-5002C	01-5878	01-5002C-25	01-5878-24	01-1210-5	29	01-1209-5		
		QC6						01-1210-6	35	01-1209-6		
		QC7						01-1210-7	41	01-1209-7		
		QC8						01-1210-8	47	01-1209-8		
		QC9						01-1210-9	53	01-1209-9		
Utility Tractor Angle Sweeper Hydraulic Drive PTO	AH/CH	QC5	10x32	01-5002C	01-5878	01-5002C-25	01-5878-24	01-1210-5	29	01-1209-5		
		QC6						01-1210-6	35	01-1209-6		
		QC7						01-1210-7	41	01-1209-7		
		QC8						01-1210-8	47	01-1209-8		
Truck and Wheel Loader Angle Sweeper Hydraulic Drive	LA / 221	QC8	10x32	01-5002C	01-5878	01-5002C-25	01-5878-24*	01-1210-8	47	01-1209-8		
		QC9						01-1210-9	53	01-1209-9		
Truck and Large Wheel Loader Angle Sweeper Hydraulic Drive	WLA / 223	WLA10	10x36	01-5003C	01-5014C	01-5003C-25	01-5014C-25	01-1212-10	58	01-1211-10		
		WLA12						01-1212-12	70	01-1211-12		

REPLACEMENT BRUSHES CONTINUED NEXT PAGE

SWEEPERS

REPLACEMENT BRUSHES CONT.

SWEEPERS

HYDRAULIC DRIVE PICK-UP SWEEPERS										
Model Description	Model Name / Series	Brush Head / Order Code	Section Size (IDxOD)	Individual Section		Packs (qty of 24/25)		Complete Set		
				Poly	Mixed (Poly / Wire)	Poly	Mixed (Poly / Wire)	Poly	Set Qty	Mixed (Poly / Wire)
SSL Collector Sweeper Hydraulic Drive	SB / 215	21560	8x26	01-5210	01-5010	01-5210-25	01-5010-24	01-1161	35	01-1167
		21572						01-1162	41	01-1168
		21584						01-9279	47	01-9278
SSL Collector Sweeper Hydraulic Drive	VRS	VRS5	8x26	01-5210	01-5010	01-5210-25	01-5010-24	*01-1161	35	*01-1167
		VRS6						*01-1162	41	*01-1168
		VRS7						*01-9279	47	*01-9278
SSL Collector Sweeper Hydraulic Drive w/ Dust Abatement System	VSS	VSS5	8x26	01-5210	01-5010	01-5210-25	01-5010-24	*01-1161	35	*01-1167
		VSS6						*01-1162	41	*01-1168
		VSS7						*01-9279	47	*01-9278
Utility Tractor Loader Collector Sweeper Hydraulic Drive	CS26 / 203	20372	8x26	01-5210	01-5010	01-5210-25	01-5010-24	01-1161	35	01-1167
		20384						01-1162	41	01-1168
		20396						01-9279	47	01-9278
Utility Tractor Loader Collector Sweeper Hydraulic Drive	CS32 / 204	20497	10x32	01-5002C	01-5878	01-5002C-25	01-5878-24	*01-1210-8	47	*01-1209-8
		20409						*01-1210-9	53	*01-1209-9
Utility Tractor Loader Collector Sweeper Hydraulic Drive	VCS26 / 203	20372	8x26	01-5210	01-5010	01-5210-25	01-5010-24	01-1161	35	01-1167
		20384						01-1162	41	01-1168
		20396						01-9279	47	01-9278
Utility Tractor Loader Collector Sweeper Hydraulic Drive	VCS32 / 204	20497	10x32	01-5002C	01-5878	01-5002C-25	01-5878-24	01-1210-8	47	01-1209-8
		20409						01-1210-9	53	01-1210-9

*BRUSH REPLACEMENT SUPERCESSION

Current Set	Superseded Set(s)	Current Set	Superseded Set(s)	Current Set	Superseded Set(s)
*01-1209-5	01-0274C	*01-1210-5	01-0272C	*01-9270	01-0716
*01-1209-6	01-0022C	*01-1210-6	01-0020C	*01-9271	01-0715
*01-1209-7	01-0081C	*01-1210-7	01-0079C	*01-1161	01-0873, 01-0851
*01-1209-8	01-0933, 01-0082C	*01-1210-8	01-0080C	*01-1162	01-9370, 01-0853
*01-1209-9	01-1148, 01-9279	*01-1210-9	01-0530C	*01-1167	01-1156, 01-9274
				*01-1168	01-9371
				*01-9279	01-1163
				*01-9278	01-1169

TILLERS



- Efficiently breaks up sod and clumps of soil, mixes in compost, prepares soil for seeding
- Hardened, replaceable tines cut 6" deep
- Bi-directional shaft undercuts and top cuts in both directions of travel
- Works next to walls, fences and other obstacles

Carrier Specifications	
Lift Capacity	Operating Weight
<9,000 lbs.	<11,000 lbs.

TILLERS



INCLUDES: TILLER AND UNIVERSAL SSL MOUNTING



TILLER	ORDER CODE	SHIP WEIGHT (LBS)
CHECK LOADER CAPACITY BEFORE ORDERING		
Fixed Offset		
52" working width Tiller	LAF3452-0022	620
68" working width Tiller	LAF3468-0022	715
Adjustable offset - Tiller offsets to cover right tire		
52" Tiller		
6" tines, 14 to 17 GPM	102000-D6-0022	660
6" tines, 18 to 28 GPM	102000-E6-0022	660
68" Tiller		
6" tines, 14 to 17 GPM	100935-D6-0022	880
6" tines, 18 to 28 GPM	100935-E6-0022	880
6" tines, 29 to 44 GPM	100935-H6-0022	880
78" Tiller		
6" tines, 29 to 44 GPM	103286-H6-0022	1110

OPTIONAL - ACCESSORIES	ORDER CODE	SHIP WEIGHT (LBS)
Scarifiers		
scarifier kit 52" set of 4	102071	40
scarifier kit 68" set of 5	102072	50
scarifier kit 78" set of 6	102307	60

TREE TOOLS

TREE FORKS



- Position plants, trees, & large shrubs quickly and with ease
- Will grasp up to 44" tree balls
- 6" tread plate on forks to firmly grip bags, boxes, pots, and rocks
- 3,000 lb. carrying capacity



TREE FORKS

TREE FORKS	ORDER CODE	SHIP WEIGHT (LBS)
tree fork universal mount	101502	630
66" hoses flat face couplers	103577	10
94" hoses flat face couplers	103603	10

OPTIONAL	ORDER CODE	SHIP WEIGHT (LBS)
pressure control valve kit	107016	40

TREE SCOOP



- Transports and places trees and shrubbery
- Digs holes for incoming trees
- Efficiently removes tree stumps
- Perfect for placing large decorative rocks and stones
- .375" plate with sharp, tapered edge

Carrier Specifications	
Lift Capacity	Operating Weight
<10,000 lbs.	<32,000 lbs.



TREE SCOOP

i **INCLUDES: SCOOP AND UNIVERSAL SSL MOUNTING TO ORDER: CHOOSE SCOOP AND MOUNTING**

TREE SCOOP CHECK LOADER CAPACITY BEFORE ORDERING	ORDER CODE	SHIP WEIGHT (LBS)
36" Ball Size Tree Scoop	LAF1836-0022	278
42" Ball Size Tree Scoop	LAF1842-0022	380
48" Ball Size Tree Scoop	LAF1848-0022	445

MOUNTING - ADDITIONAL COST MAY APPLY	ORDER CODE	SHIP WEIGHT (LBS)
Contact Customer Service at (833) 723-1843		

TREE SPADE



- Available in 2 series:
25° modified truncated series
30° cone model
- Standard electric control joystick to function the hydraulic valve
- Overlapping blades to clean cut roots
- Adjustable legs slide to control ball depth
- Wide gate opening to engage tree easily

Specifications								
Model	Overall Height	Overall Width	Digging Depth	Blades	Ball Dia.	Blade Angle	Ball Weight	Weight w/o chain (lbs)
2030	42"	46"	16"	3	16" - 20"	30°	80 - 120 lbs	650
2625	48"	56"	22"	3	18" - 26"	25°	150 - 350 lbs	1150
3625	65"	66"	31"	3	24" - 36"	25°	250 - 1000 lbs	1550
4425	65"	63"	31"	4	32" - 44"	25°	1200 - 1500 lbs	1825

TREE SPADE



**INCLUDES: TREE SPADE AND UNIVERSAL SSL MOUNTING
TO ORDER: CHOOSE SPADE, BLADE SET (IF REQUIRED) AND MOUNTING**



NOTE: Consult Factory for specific mounts. See specs to determine spade size and machine capacity requirement.

TREE SPADE WITH ELECTRIC VALVE & JOYSTICK CONTROL		ORDER CODE	SHIP WEIGHT (LBS)
Tree Spade			
2030 model with blade (mount required)		25605	650
25 Series - (includes blades) (no under cutter)			
2625 model 25° with blades*		25670	1150
3625 model 25° with blades*		25370	1550
4425 model 25° with blades*		25570	1875
OPTIONS		ORDER CODE	SHIP WEIGHT (LBS)
12' long control cable extension cord for use on tractor and wheel loader mounts		25519	10
16' long control cable extension cord for use on tractor and wheel loader mounts		25874	10
25' long control cable extension cord for use on tractor and wheel loader mounts		25869	10
replaceable joystick included in base unit		25425	10
MOUNTS FOR 2030 (INCLUDES HYDRAULIC KIT)		ORDER CODE	SHIP WEIGHT (LBS)
mini loader universal mount for 2030		25608	68
universal skid steer mount for 2030		25696	250
ASV RC30 / Polaris ASL 300 / Polaris		25744	150
Bobcat MT50 / MT52 mount for 2030		25689	150

TRENCHERS



TRENCHERS

Bradco Trenchers, by Paladin, can mount to skid-steer loaders, compact skid-steer loaders and 3-point PTO HP hydrostatic tractors. Several boom lengths are available to match your job's specifications.



HOW TO ORDER AN ATTACHMENT

Since many of our attachments are customized to your needs, when you place your order you will need to choose your attachment, the mounting, and any options you would like. As you look through the products, notice the red headings in the charts - they will alert you to the choices you need to make.

Choose your attachment	TRENCHER ASSEMBLY (INCLUDES 4 FOOT HOSES WITH 6 FJX HOSE END)	ORDER CODE	SHIP WEIGHT (LBS)
	330 trencher assembly, 15 - 30 HP	11135	465
Choose assemblies	BOOM & CRUMBER ASSEMBLIES	ORDER CODE	SHIP WEIGHT (LBS)
	30" digging depth (29 stations)	111385	85
	36" digging depth (32 stations)	111374	85

The blue information bar will tell you what is included in the price and what you need to choose to order a complete attachment. It may also include other helpful information.

INCLUDES: 612 TRENCHER, PTO DRIVE SHAFT (20-45 HP) AND HYDRAULIC HOOK-UP KIT
TO ORDER: CHOOSE TRENCHER ASSEMBLY, BOOM & CRUMBER ASSEMBLY AND CHAIN & TEETH ASSEMBLY

The warning box contains important information pertaining to the attachment and prime mover and/or other safety information.

IMPORTANT: Front counter weight may be necessary for proper transportation of the tractor and trencher attachment. Requires rear hydraulics to run machine.

TRENCHER MODEL 330

3-POINT HITCH (CATEGORY 1) HYDROSTATIC TRANSMISSION AND REAR REMOTES



- Category 1ASAE S217.12 standard, 3-point mount for 15-30 PTO HP hydrostatic tractors
- Maintenance free PTO shaft drive with automatic slip clutch for overload protection
- 14" discharge auger
- 30" & 36" digging depth available to fit most applications
- 38,000 lb 1.654" anti-back flex-chain for tooth pattern versatility to support many soil types and conditions
- Compatible with model 615 chains
- ASAE S278.6 standard quick attach compatible
- Support stand is a standard feature

Specifications - Transport

Trench Depth w/ Auger at 65° Digging Angle	Chain Width	Recom'd Trenching Angle	Headshaft Height (Auger Touching Ground)	Overall Length	Overall Width	Overall Height	Spoil Discharge Reach	Length from 3-Point to Headshaft (center of gravity)	Transport Angle	Weight w 6"x 36" Chain, Boom & Crumber
30"	3", 4.5", 6", 8"	65°	8.5"	73"	38"	29"	21"	24"	48°	650 lbs
36"	3", 4.5", 6", 8"	65°	8.5"	79"	38"	29"	21"	24"	48°	650 lbs

Specifications - Hydraulic System

Operating Hydraulic System	Rear PTO RPM Rating	Rear PTO HP Rating
2,000 to 2,500 PSI	540 RPM	15 to 30 HP



IMPORTANT: Front counter weight may be necessary for proper transportation of the tractor and trencher attachment. Requires rear hydraulics to run machine.

TRENCHER MODEL 330



TO ORDER: CHOOSE TRENCHER ASSEMBLY, BOOM & CRUMBER ASSEMBLY AND CHAIN & TEETH ASSEMBLY

TRENCHER ASSEMBLY (INCLUDES 4 FOOT HOSES WITH 6 FJX HOSE END)

	ORDER CODE	SHIP WEIGHT (LBS)
330 trencher assembly, 15 - 30 HP	111135	465

BOOM & CRUMBER ASSEMBLIES

	ORDER CODE	SHIP WEIGHT (LBS)
30" digging depth (29 stations)	111385	85
36" digging depth (32 stations)	111374	85

330 TRENCHER CONTINUED ON THE NEXT PAGE

TRENCHERS

TRENCHER MODEL 330 CONT.

CHAIN & TEETH ASSEMBLIES (MUST MATCH BOOM & CRUMBER SIZE)	ORDER CODE	SHIP WEIGHT (LBS)
38,000# / 1.654 Pitch / Cut-Type Teeth / Tooth Every Station		
for 30" boom 3" wide chain	112533	65
for 30" boom 4.5" wide chain	16687	70
for 30" boom 6" wide chain	16686	76
for 30" boom 8" wide chain	16685	88
for 36" boom 3" wide chain	112531	70
for 36" boom 4.5" wide chain	89822	76
for 36" boom 6" wide chain	89823	84
for 36" boom 8" wide chain	89824	96
38,000# / 1.654 Pitch / 70/30 Combination Shark-Type / Cup-Type Teeth / Tooth Every Station		
for 30" boom 3" wide chain	112454	70
for 30" boom 4.5" wide chain	112562	73
for 30" boom 6" wide chain	18767	80
for 30" boom 8" wide chain	18768	86
for 36" boom 3" wide chain	112453	100
for 36" boom 4.5" wide chain	89825	76
for 36" boom 6" wide chain	89826	83
for 36" boom 8" wide chain	89827	92

OPTIONS	ORDER CODE	SHIP WEIGHT (LBS)
Valve assembly for use when tractor is not equipped with rear remote couplers	112573	20

REPLACEMENT PARTS	ORDER CODE	SHIP WEIGHT (LBS)
Tooth Left 1.654 - Cup Style	31595	
Tooth Right 1.654 - Cup Style	31596	
Tooth Center 1.654 - Shark Style	31592	
Tooth Left 1.654 - Shark Style	31593	
Tooth Right 1.654 - Shark Style	31594	
Digging Chain,30" - Bare	17013	
Digging Chain,36" - Bare	17014	
Hose .25x48 6fj-6fj90s 100r2at	37751	
Cylinder Assembly	111389	

TRENCHER MODEL 612

3-POINT HITCH (CATEGORY 1) HYDROSTATIC TRANSMISSION AND REAR REMOTES



- PTO shaft-drive with heavy duty slip clutch for overload protection
- Gearbox drive with chain reduction to the headshaft giving productive digging chain speed
- 24" discharge auger, places dirt well away from the trench
- Several tooth options available
 - cup
 - shark
 - rock & frost
- 50,000 lb 2" anti-back flex-chain

Specifications - 3-Point Mounting											
Trench Depth	Trench Width	Trenching Angle	Auger Diameter	Width	Headshaft Height (Auger Touching Ground)	Length from 3-Point to Headshaft	Spoil Discharge Reach	Transport Height	Center of Trencher to End of Auger	Trencher Length with 4' Boom	
30", 36", 48", 60"	6", 8", 10", 12"	65°	24"	43"	12"	24"	29"	Varies	27"	96"	

Maximum Trenching Depths Based on Trench Width			
6" Wide	8" Wide	10" Wide	12" Wide
60" Deep	48" Deep	36" Deep	30" Deep

Digging Chain Specifications	
Double Standard, anti-backflex	Standard Chain Pitch
50,000 lbs	2"

! **IMPORTANT:** Front counter weight may be necessary for proper transportation of the tractor and trencher attachment. Shipped fully assembled, ready to mount on tractor.

TRENCHER MODEL 612



i **INCLUDES:** 612 TRENCHER, PTO DRIVE SHAFT (20-45 HP) AND HYDRAULIC HOOK-UP KIT
TO ORDER: CHOOSE TRENCHER ASSEMBLY, BOOM & CRUMBER ASSEMBLY AND CHAIN & TEETH ASSEMBLY

TRENCHER ASSEMBLY	ORDER CODE	SHIP WEIGHT (LBS)
612 Trencher	78592	615

BOOM & CRUMBER ASSEMBLY	ORDER CODE	SHIP WEIGHT (LBS)
30" digging depth 23 stations	110631	101
36" digging depth 26 stations	110632	111
48" digging depth 33 stations	110633	149
60" digging depth 40 stations	110634	188

! **NOTE:** 48" & 60" boom & crumber assembly includes chain tightener kit, not required on 30" and 36" assemblies due to design.

612 TRENCHER CONTINUED ON THE NEXT PAGE

TRENCHERS

TRENCHER MODEL 612 CONT.

CHAIN & TEETH ASSEMBLY (MUST MATCH BOOM & CRUMBER SIZE)		ORDER CODE	SHIP WEIGHT (LBS)
50,000# Chain / 2.00" Pitch / Tooth Every Station			
for 30" boom 6" wide chain		80044	107
for 30" boom 8" wide chain		80045	115
for 30" boom 10" wide chain		80046	127
for 30" boom 12" wide chain		80047	142
for 36" boom 6" wide chain		80048	132
for 36" boom 8" wide chain		80049	139
for 36" boom 10" wide chain		80050	152
for 36" boom 12" wide chain		80822	190
for 48" boom 6" wide chain		80051	157
for 48" boom 8" wide chain		80052	167
for 60" boom 6" wide chain		80053	173
50,000# Chain / 2.00" Pitch / Tooth Every Other Station			
for 30" boom 6" wide chain		80034	86
for 30" boom 8" wide chain		80035	91
for 30" boom 10" wide chain		80036	95
for 30" boom 12" wide chain		80037	105
for 36" boom 6" wide chain		80038	100
for 36" boom 8" wide chain		80039	105
for 36" boom 10" wide chain		80040	113
for 48" boom 6" wide chain		80041	127
for 48" boom 8" wide chain		80042	134
for 60" boom 6" wide chain		80043	149
Combination Chain Assemblies: 50/50 Rock & Frost / Cup Teeth			
for 30" boom 6" wide chain		83702	145
for 36" boom 6" wide chain		83703	165
for 48" boom 6" wide chain		83704	205
Combination Chain Assemblies: 70/30 Aggressive Shark-Style / Cup Teeth			
for 30" boom 6" wide chain		31539	99
for 36" boom 6" wide chain		31540	117
for 48" boom 6" wide chain		31541	155
for 60" boom 6" wide chain		31542	195
Shark-Style Tooth Chain Assemblies: 50,000# ABF Chain / 2.00" Pitch			
for 30" boom 6" wide chain		31543	105
for 36" boom 6" wide chain		31544	130
for 48" boom 6" wide chain		31545	170
OPTIONS		ORDER CODE	SHIP WEIGHT (LBS)
stand for model 612 trencher		88167	20

special paint color - contact factory for order code

TRENCHER MODEL 612 CONT.

REPLACEMENT PARTS	ORDER CODE	SHIP WEIGHT (LBS)
Tooth,Left,2.00p - Cup Style	54431	
Tooth,Right,2.00p - Cup Style	54432	
Tooth Left 2.00 - Shark Style	31600	
Tooth Center 2.00 - Shark Style	31599	
Tooth Right 2.00 - Shark Style	31601	
Hose .38x50 6mp-6fj 100r2at Hs	35871	
Cylinder Assembly	60964	

TRENCHER MODEL 625 UNIVERSAL SKID-STEER MOUNTING



- 30", 36", 42" & 48" digging depth available to fit most applications
- Heavy-duty boom & crumber with replaceable wear strips
- Allows tight fit with single side spoil augering
- Replaces dedicated machines at a fraction of the cost
- Several tooth options available
 - cup
 - shark
 - rock & frost
- 50,000 lb 2" anti-back flex-chain for tooth pattern versatility to support many soil types and conditions
- Two position manual side shift mounting with optional infinite position using hydraulic side shift cylinder assembly

Specifications									
Boom Size	Trench Depth w/ Auger at 65° Digging Angle	Chain Width	Recom'd Trenching Angle	Headshaft Height (Auger Touching Ground)	Overall Length	Overall Width	Overall Height	Spoil Discharge Reach	Side Shift, Right of Center
30"	30"	6", 8", 10", 12"	65°	8"	66"	53"	32"	18"	17"
36"	36"	6", 8", 10"	65°	8"	73"	53"	32"	18"	17"
42"	42"	6", 8", 10"	65°	8"	79"	53"	32"	18"	17"
48"	48"	6", 8"	65°	8"	86"	53"	32"	18"	17"

Specifications - Hydraulic System	
GPM Requirements	Operating Pressure
Min 14 / Max 22	2000 to 3000 PSI

TRENCHER MODEL 625

COMPLETE 625 TRENCHER WITH BOOM, CHAIN/TEETH ASSEMBLIES & HOSES	ORDER CODE	SHIP WEIGHT (LBS)
36" digging depth, 6" wide chain, tooth every station	103584	962
48" digging depth, 6" wide chain, tooth every station	117765	1150
48" digging depth, 6" wide chain, 70/30 tooth every station	117766	1150

625 TRENCHER CONTINUED NEXT PAGE

TRENCHERS

TRENCHER MODEL 625 CONT.



TO ORDER: CHOOSE TRENCHER ASSEMBLY, BOOM & CRUMBER ASSEMBLY, CHAIN & TEETH ASSEMBLY AND HYDRAULIC KIT

TRENCHERS

TRENCHER ASSEMBLY	ORDER CODE	SHIP WEIGHT (LBS)
model 625 trencher 14 to 22 GPM	89220	850

BOOM & CRUMBER ASSEMBLIES	ORDER CODE	SHIP WEIGHT (LBS)
30" digging depth (24 stations)	89281	104
36" digging depth (27 stations)	89282	115
42" digging depth (31 stations)	89283	128
48" digging depth (34 stations)	89284	140

CHAIN & TEETH ASSEMBLIES (MUST MATCH BOOM & CRUMBER SIZE)	ORDER CODE	SHIP WEIGHT (LBS)
50,000# Chain / 2.00" Pitch / Tooth Every Station		
for 30" boom 6" wide chain	79154	110
for 30" boom 8" wide chain	79155	118
for 30" boom 10" wide chain	79156	130
for 30" boom 12" wide chain	79157	145
for 36" boom 6" wide chain	79099	135
for 36" boom 8" wide chain	79100	142
for 36" boom 10" wide chain	79158	155
for 36" boom 12" wide chain	81120	190
for 42" boom 6" wide chain	82114	148
for 42" boom 8" wide chain	82115	156
for 42" boom 10" wide chain	82116	170
for 48" boom 6" wide chain	79101	160
for 48" boom 8" wide chain	79102	170
50,000# Chain / 2.00" Pitch / Tooth Every Other Station		
for 30" boom 6" wide chain	79181	89
for 30" boom 8" wide chain	79182	94
for 30" boom 10" wide chain	79183	98
for 30" boom 12" wide chain	79184	108
for 36" boom 6" wide chain	79185	103
for 36" boom 8" wide chain	79186	108
for 36" boom 10" wide chain	79187	116
for 42" boom 6" wide chain	82117	117
for 42" boom 8" wide chain	82118	123
for 42" boom 10" wide chain	82119	132
for 48" boom 6" wide chain	79188	130
for 48" boom 8" wide chain	79189	137

625 TRENCHER CONTINUED NEXT PAGE

TRENCHER MODEL 625 CONT.

CHAIN & TEETH ASSEMBLIES (MUST MATCH BOOM & CRUMBER SIZE)	ORDER CODE	SHIP WEIGHT (LBS)
Combination Chain Assembly: 50/50 Rock & Frost / Bullet Teeth / Cup Teeth		
for 30" boom 6" wide chain	83706	152
for 36" boom 6" wide chain	83707	182
for 42" boom 6" wide chain	83708	212
for 48" boom 6" wide chain	83709	242
Combination Chain Assembly: 70/30 Aggressive Shark-Style Teeth / Cup Teeth		
for 30" boom 6" wide chain	31546	118
for 36" boom 6" wide chain	31547	133
for 42" boom 6" wide chain	31563	153
for 48" boom 6" wide chain	31548	168
Shark-Style Tooth Chain Assembly: 50,000# ABF Chain 2.00" Pitch		
for 30" boom 6" wide chain	31549	121
for 36" boom 6" wide chain	31550	137
for 42" boom 6" wide chain	31551	151
for 48" boom 6" wide chain	31552	172

HYDRAULIC KITS	ORDER CODE	SHIP WEIGHT (LBS)
97" long hose/coupler universal flat face	19709	20
97" long hoses & case old style couplers (XT series)	89603	20
82" long hoses ONLY	89604	15
97" long hoses ONLY (XT series)	89605	17
Skid-Steer Loader Universal Hydraulic Quick Couplers		
flat face female coupler (.5" pipe thread)	84925	2
flat face male coupler (.5" pipe thread)	84924	2
flat face female coupler (12 o-ring)	22518	2
flat face male coupler (12 o-ring)	22519	2

OPTIONS	ORDER CODE	SHIP WEIGHT (LBS)
hydraulic side shift with diverter valve	89412	52
hydraulic side shift without diverter valve (requires 2 sets of auxiliary outlets)	89279	40

REPLACEMENT PARTS	ORDER CODE	SHIP WEIGHT (LBS)
Tooth,Left,2.00p - Cup Style	54431	
Tooth,Right,2.00p - Cup Style	54432	
Tooth Left 2.00 - Shark Style	31600	
Tooth Center 2.00 - Shark Style	31599	
Tooth Right 2.00 - Shark Style	31601	
Chain,Trencher,2.00p, Bare	79018	

TRENCHERS

TRENCHER MODEL 640 UNIVERSAL SKID-STEER MOUNTING



- 5 motor options to match the flow of many skid-steer loaders
- Two position manual side shaft mounting with optional infinite position
- 30", 36", 42" & 48" digging depth available to fit most applications, 60" high flow only
- Mechanical side shift
- Fixed length booms available featuring spring-loaded, self adjusting idler with full rock guards
- Heavy-duty boom & crumber
- Several tooth options available
 - cup
 - shark
 - rock & frost
- 50,000 lb 2" anti-back flex-chain for tooth pattern versatility to support many soil types and conditions

Specifications									
Boom Size	Trench Depth w/ Auger at 65° Digging Angle	Chain Width	Recom'd Trenching Angle	Headshaft Height (Auger Touching Ground)	Overall Length	Overall Width	Overall Height	Spoil Discharge Reach	Side Shift, Right of Center
30"	30"	6", 8", 10", 12"	65°	8"	66"	53"	32"	18"	17"
36"	36"	6", 8", 10", 12"	65°	8"	73"	53"	32"	18"	17"
42"	42"	6", 8", 10"	65°	8"	79"	53"	32"	18"	17"
48"	48"	6", 8"	65°	8"	86"	53"	32"	18"	17"
60"	60"	6"	65°	8"	94"	55"	57"	24"	17"

Specifications - Hydraulic System		
GPM Requirements (standard flow)	GPM Requirements (high flow)	Operating Pressure
14 to 28	29 to 44	Max 3500 PSI

TRENCHER MODEL 640



TO ORDER: CHOOSE TRENCHER ASSEMBLY, BOOM & CRUMBER ASSEMBLY, CHAIN & TEETH ASSEMBLY AND HYDRAULIC KIT

COMPLETE 640 TRENCHER WITH BOOM & CHAIN/TEETH ASSEMBLIES (INLCLUDES HOSES)-MUST ORDER COUPLERS	ORDER CODE	SHIP WEIGHT (LBS)
48" digging depth, 6" wide chain, 18-26 gpm, 70/30 tooth every station	122395	1158

TRENCHER ASSEMBLY	ORDER CODE	SHIP WEIGHT (LBS)
Basic Trencher (Includes Hoses) - must order couplers		
model 640 14-18 GPM (Standard Flow)	100268	850
model 640 18-26 GPM (Standard Flow)	100269	850
model 640 25-28 GPM (Standard Flow)	102326	850
model 640 29-35 GPM drain line required (High Flow)	100270	900
model 640 36-44 GPM drain line required (High Flow)	102325	900

640 TRENCHER CONTINUED NEXT PAGE

TRENCHER MODEL 640 CONT.

BOOM & CRUMBER ASSEMBLIES	ORDER CODE	SHIP WEIGHT (LBS)
30" digging depth (24 stations)	89281	104
36" digging depth (27 stations)	89282	115
42" digging depth (31 stations)	89283	128
48" digging depth (34 stations)	89284	140
60" digging depth (40 stations) (for 100270 / 102325)	100272	180

CHAIN & TEETH ASSEMBLIES (MUST MATCH BOOM & CRUMBER SIZE)	ORDER CODE	SHIP WEIGHT (LBS)
50,000# Chain / 2.00" Pitch / Tooth Every Station		
for 30" boom 6" wide chain	79154	110
for 30" boom 8" wide chain	79155	118
for 30" boom 10" wide chain	79156	130
for 30" boom 12" wide chain	79157	145
for 36" boom 6" wide chain	79099	135
for 36" boom 8" wide chain	79100	142
for 36" boom 10" wide chain	79158	155
for 36" boom 12" wide chain	81120	190
for 42" boom 6" wide chain	82114	148
for 42" boom 8" wide chain	82115	156
for 42" boom 10" wide chain	82116	170
for 48" boom 6" wide chain	79101	160
for 48" boom 8" wide chain	79102	170
for 60" boom 6" wide chain	80053	173
50,000# Chain / 2.00" Pitch / Tooth Every Other Station		
for 30" boom 6" wide chain	79181	89
for 30" boom 8" wide chain	79182	94
for 30" boom 10" wide chain	79183	98
for 30" boom 12" wide chain	79184	108
for 30" boom 6" wide chain	79181	89
for 36" boom 6" wide chain	79185	103
for 36" boom 8" wide chain	79186	108
for 36" boom 10" wide chain	79187	116
for 42" boom 6" wide chain	82117	117
for 42" boom 8" wide chain	82118	123
for 42" boom 10" wide chain	82119	132
for 48" boom 6" wide chain	79188	130
for 48" boom 8" wide chain	79189	137
for 60" boom 6" wide chain	80043	149
Combination Chain Assembly: 50/50 Rock & Frost / Bullet Teeth / Cup Teeth		
for 30" boom 6" wide chain	83706	152
for 36" boom 6" wide chain	83707	182
for 42" boom 6" wide chain	83708	212
for 48" boom 6" wide chain	83709	242
for 60" boom 6" wide chain	83705	265

640 TRENCHER - GROUP 3 CONTINUED NEXT PAGE

TRENCHERS

TRENCHER MODEL 640 CONT.

CHAIN & TEETH ASSEMBLIES CONT. (MUST MATCH BOOM & CRUMBER SIZE)	ORDER CODE	SHIP WEIGHT (LBS)
Combination Chain Assembly: 70/30 Aggressive Shark-Style Teeth / Cup Teeth		
for 30" boom 6" wide chain	31546	118
for 36" boom 6" wide chain	31547	133
for 42" boom 6" wide chain	31563	153
for 48" boom 6" wide chain	31548	168
for 60" boom 6" wide chain	31542	195
Shark-Style Tooth Chain Assembly: 50,000# ABF Chain 2.00" Pitch		
for 30" boom 6" wide chain	31549	121
for 36" boom 6" wide chain	31550	137
for 42" boom 6" wide chain	31551	151
for 48" boom 6" wide chain	31552	172

QD SETS	ORDER CODE	SHIP WEIGHT (LBS)
QD Sets Standard Flow		
.50" body flat face couplers	23609	4
.62" body flat face couplers	124359	4
QD Sets High Flow		
.50" body with .38" male drain	119996	5
.50" body with .38" female drain	119997	5
.62" body with .38" male drain	119998	5
.62" body with .38" female drain	119999	5
.75" body with .25" male drain	120000	5
.75" body with .38" male drain	120001	5
.75" body with .38" female drain	120002	5
.75" body with .50" male drain	120003	5

REPLACEMENT PARTS	ORDER CODE	SHIP WEIGHT (LBS)
Tooth,Left,2.00p - Cup Style	54431	
Tooth,Right,2.00p - Cup Style	54432	
Tooth Left 2.00 - Shark Style	31600	
Tooth Center 2.00 - Shark Style	31599	
Tooth Right 2.00 - Shark Style	31601	
Chain,Trencher,2.00p, Bare	79018	
Hose .62x123 10fj-12mb 100r19 Hs - Std Flow	38231	
Hose .75x123 12fj-12mb 100r19 Hs (Ce) - High Flow	38279	
Hose .25x132 6fj-6fj 100r2at Hs - High Flow	37482	

TRENCHER CHAIN SELECTION GUIDE

TOOTH EVERY STATION (TES)

Designed for standard digging conditions, light to moderately compacted, sandy, loam soils and loosely-packed gravelly soils. Typically good digging conditions.



TOOTH EVERY OTHER STATION (TEOS)

Tooth pattern designed to give the most production in wet, sticky conditions such as gumbo, wet clay, etc. TEOS allows the sticky soils to be discharged as it comes around the head shaft sprocket allowing the auger to pick it up and discharge spoil to the side of the trench. The TES chain has a tendency to hold the sticky soils causing build-up in the chain and loss of production.



ROCK & FROST CHAIN 50/50: COMBINATION 50% ROCK & FROST / 50% CUP TEETH (R&F)

The rock and frost chain will give the highest production in frozen ground, highly compacted soils and rock, allowing the cup teeth to pick up and clean the trench. The R&F chain is very aggressive in tough conditions, but is not as productive in the lighter, normal digging conditions.

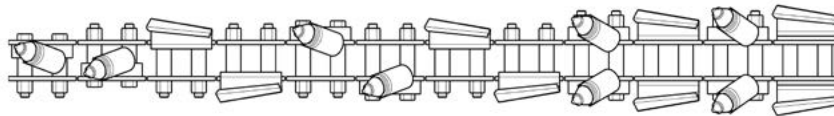

SHARK TOOTH CHAIN 70/30: COMBINATION 70% SHARK / 30% CUP TEETH (70/30)

The 70/30 chain should be applied in compacted soils, light frozen ground, baked hard clay, shale or rocky soils. The aggressive shark teeth will slice, break and relieve the tough soils, allowing the cup teeth to follow and clean the trench. As with the R&F chain, the 70/30 chain will not be as productive in the lighter, normal conditions as the TES chain.

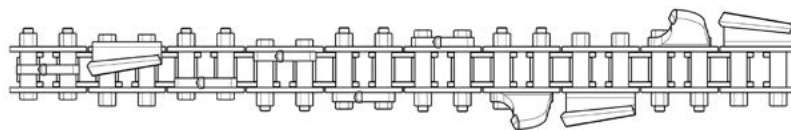

FULL SHARK TOOTH CHAIN (100% SHARK TEETH)

The full shark tooth chain is recommended in fracturable rock, shale, caliche or conditions with little or no loose soil. This chain will not efficiently clean the trench in sand, silt and high-moisture clay conditions.

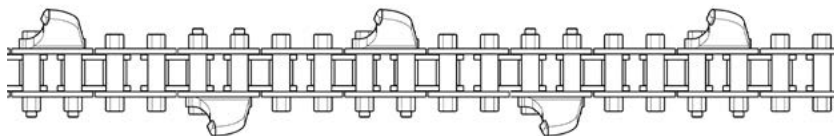

CHAIN WIDTHS

4" wide chain



6" wide chain



8" wide chain



10 - 12" wide chain

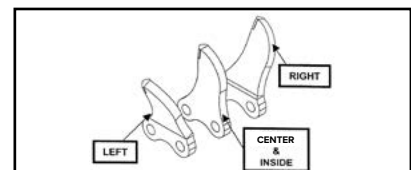

VIBRATORY PLOWS

VIBRATORY PLOW



- 12' turning radius
- Rotating coultter wheel frame mounted
- Optional hydraulic steering assembly
- Optional cable chute blades, reel mount, and pulling accessories available

VIBRATORY PLOW FOR COMPACT TRACTORS



VIBRATORY PLOW ASSEMBLY	ORDER CODE	SHIP WEIGHT (LBS)
Model VP10 8 to 11 GPM	19733	467
Model VP10 10 to 14 GPM	19734	467

HYDRAULIC KITS	ORDER CODE	SHIP WEIGHT (LBS)
without steering, .50" poppet couplers	19380	10
without steering, .50" flat face couplers	19381	10
with steering, .50" poppet couplers*	19382	25
with steering, .50" flat face couplers*	19383	25

*Skid-Steer must have two sets of auxiliary hydraulics

MOUNTING KITS	ORDER CODE	SHIP WEIGHT (LBS)
3-point category I mounting kit	101827	45

VIBRATORY PLOW BLADES	ORDER CODE	SHIP WEIGHT (LBS)
.375" (3/8") Wide Blade		
.375" blade 20°, 1" clevis, 6" to 12" depth	19325	25
.375" blade 30°, 1" clevis, 6" to 12" depth	19441	20
.375" blade 20°, 1" clevis, 12" to 18" depth	18690	25
.375" blade 30°, 1" clevis, 12" to 18" depth	2007030	25
.50" (1/2") Wide Chute Blade		
.50" chute blade 20°, 6" to 12" depth	19442	40
.50" chute blade 30°, 6" to 12" depth	19443	40
.50" chute blade 20°, 12" to 18" depth	19444	45
.50" chute blade 30°, 12" to 18" depth	19445	45
.50" chute blade 20°, 20" to 24" depth	109214	31
.50" chute blade 30°, 18" to 24" depth	112256	53

OPTIONS	ORDER CODE	SHIP WEIGHT (LBS)
pull bullet assembly, 2.5" dia	17754	5
cable pull grip, 1" to 1.24" cable	2001171	3
cable pull grip, .75" to .99" dia.	100435	3
cable pull grip, 1.25" to 1.49" dia.	100436	3
pipe bullet assembly, 1" to 1.5" pipe	18740	5
cable reel mount, 24" max. dia. reel	19085	26
hydraulic steering assembly (Must select one steering conversion kit below)	18739	29
steering conversion kit, .50" poppet couplers	19732	20
steering conversion kit, .50" flat face couplers	19735	20

VIBRATORY ROLLERS

VIBRATORY ROLLER



- Protected & isolated hydraulic drive
- High production smooth & padded rollers available
- Steel drum has adjustable steel scraper blade between the frame and drum ensuring smooth and uniform compaction

! **IMPORTANT: Flow range 14 to 22 GPM and max pressure of 3,000 PSI**

Specifications											
Model #	Overall Width	Drum Width	Overall Height	Overall Length	Drum Diameter	Operating Weight (lbs)	Dynamic Force (lbs)	Vibrating Speed (vpm)	Vibrating Weight (lbs)	Drum Oscillation/Tile	Hydraulic Motor Flow (gpm)
Smooth Drum											
105061	61"	48"	31"	39"	24"	1680	5750	2600	935	15°	25
105062	72"	66"	31"	39"	24"	2150	7800	2600	1190	15°	25
105063	79"	73"	31"	39"	24"	2300	8550	2600	1290	15°	25
105064	90"	84"	31"	39"	24"	2530	9370	2600	1440	15°	25
Padded Drum											
105065	61"	48"	31"	39"	20"	1630	5750	2600	507	15°	25
105066	72"	66"	31"	39"	24"	2085	7800	2600	935	15°	25
105067	79"	73"	31"	39"	24"	2230	8550	2600	1190	15°	25
105068	90"	84"	31"	39"	24"	2455	9370	2600	1290	15°	25

VIBRATORY ROLLER FOR SKID-STEER LOADERS



INCLUDES: VIBRATORY ROLLER, 80" HOSES AND .50 BODY FLAT FACE COUPLERS

	ORDER CODE	SHIP WEIGHT (LBS)
Smooth Drum		
48" smooth drum	105061	1680
66" smooth drum	105062	2150
73" smooth drum	105063	2300
84" smooth drum	105064	2530
Padded Drum		
48" padded drum	105065	1630
66" padded drum	105066	2085
73" padded drum	105067	2230
84" padded drum	105068	2455

MISCELLANEOUS

HOSE SAVER SPRING KIT

ORDER CODE

SHIP WEIGHT
(LBS)

Allows adjustment of hose routing to prevent hose pinching between quick attach implement and power unit. Easily installed by welding #10136 on any implement or loader attachment that uses hydraulics.

.25 ID hose	103177	5
.38 ID hose	103178	5
.50 ID hose	103179	5
.62 ID hose	103454	5
.75 ID hose	103455	5
nut, spring base weld-on	10136	2

POWERFUL ATTACHMENT TOOLS



**SELECTION.
INNOVATION.
PERFORMANCE.**



PALADIN®